



**CZECH  
REPUBLIC**

packaging.cz



**Vlašim**

**Bag Form Fill and Seal Machines**

**Horizontal Packaging Machines**

**Dosing Weighers**

**Manual Dosing Units**

**Conveyers**

**Dosers**



**Dear business friends,**

We take pleasure in introducing you ASTRO Vlašim spol. s r.o., a packaging equipment producer with headquarters in Vlašim. The company was founded in 1992 and had a core team of 10 employees. Its objective was to construct and manufacture very simple, reasonably priced packaging machines, suitable above all for small companies just starting out. Growing demand on the market has resulted in dynamic technical development and an expansion of production capacities to the current 45 employees. Improved quality is confirmed by deliveries of complete lines not just to domestic companies, but also to renowned companies abroad.

The core programme for the future remains the development of Vertical Form Fill & Seal Machines and their accessories. In the production of this machinery emphasis is placed on the quality and unification of parts. An integral part of company strategy is providing a reliable guarantee and post guarantee service, as well as supplies of spare parts. The products are approved and correspond to the standards for CCZ and GOST certification. They also comply with EU standards and carry the CE label.

Thank you for studying this material. We are always prepared to react to any interest you might have and to deal with your requirements.

**Machine Program**

Our production program is designed to be able to offer complete packaging technologies for food and non-food industry.

- Vertical Form Fill and Seal Machines
- Horizontal Packaging Machines
- Dosers
  - Screw Dosers
  - Flap Dosers
  - Slide Valve Dosers
- Dosing Weighers
- Manual Dosing Units
- Automatic Dosing Machines
- Conveyers
  - Belt Conveyers
  - Screw Conveyers
  - Bucket Conveyers
  - Discharge Conveyors
  - Rotary Collecting Tables
- Checkweighers

# Vertical form fill and seal machines MH1, MH2

## What can you pack?

- loose goods
- granulate
- small piece goods
- liquids

## Packing capacity

- maximum speed 130 bags per minute
- packing capacity depends on bag size, kind of goods and capacity of used filler

## Bag types

- pillow bag
- gusset bag
- bag with welded edges
- bag with euro hole
- bag with folded bottom and folded upper weld with a sticker

Together with above mentioned we can offer also other types of bags.

## Machines Advantages

- electronic services
- low energy intensity
- comfortable control
- statistics printing

## Package size

- bags width from 30 mm to 500 mm
- length of bags from 80 mm to 1025 mm



Packaging machine MH1bb with dosing weigher AV2/2



Packaging machine MH2bb with flap doser KL1



Packaging machine MH2bb with auger filler SD2bb

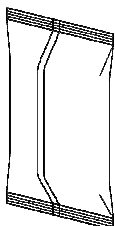

pillow bag

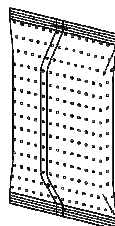

boiling bag

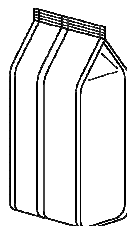

bag with welded edges

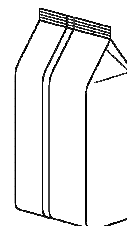

gusset bag

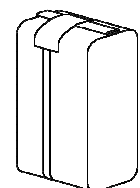

bag with folded bottom and top with label

## Vertical form fill and seal machines MH1, MH2

	MH1bb	MH1cb	MH1db	MH2bb	MH2eb	MH3af
<b>Capacity</b>	to 75 bags/min.	to 70 bags/min.	to 50 bags/min.	to 130 bags/min.	to 40 bags/min.	to 35 bags/min.
<b>Dose volume</b>	to 2500 ml	to 5000 ml	to 15 litres	to 2500 ml	to 70 litres	to 2500 ml
<b>Bag width</b>	65 – 206 mm	65 - 325 mm	65 - 350 mm	45 – 210 mm	270 - 500 mm	65 - 206 mm
<b>Bag length</b>	80 – 320 mm	80 – 400 mm	100 - 460 mm	50 – 310 mm	200 -1025 mm	80 - 310 mm

### Sealed edges



- the device allows producing bags with sealed edges on a vertical or horizontal packaging machine
- quick and cheap solution
- equipment is suitable for vertical packaging machine MH1 or MH2
- possible to install on machines from other manufacturers
- can be used for all bag sizes and types

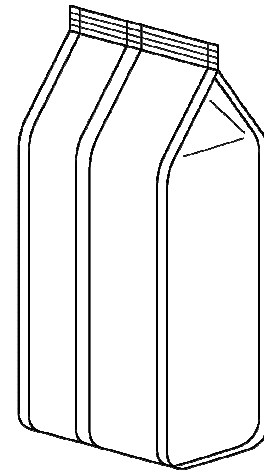

### Electronic service

- Service machines anywhere in the world without having to visit service technician
- Inspection immediately after notification of defects
- Machine setting-up
- Optimization of machines for work
- Elimination of software errors

Remote services may be granted only to machine ASTRO Vlašim spol. s r.o. equipped with communication equipment connected to telephone line or mobile phone with data transmission.

## Dosers

### Screw dosers SD

- maximum output 110 doses per minute
- dose volume according to doser type from 10 ml to 20000 ml
- screw dosers are suitable for dosing loose goods, such as ground coffee, spices, flour mixtures, etc.
- dosers can be used on machines from other manufacturers
- split hopper for easy cleaning



### Volumetric Flap Doser KL1

- maximum output 110 doses per minute
- dose volume from 85 ml to 1840 ml
- flap doser is suitable for dosing bulk goods such as rice, coffee beans, peas, pasta, etc.
- dosers can be used on machines from other manufacturers



### Volumetric Friction Doser MD2

- maximum output 60 doses per minute
- dose volume from 80 ml to 960 ml
- doser is suitable for dosing loose goods such as rice, coffee beans, peas, pasta, etc.
- dosers can be used on machines from other manufacturers

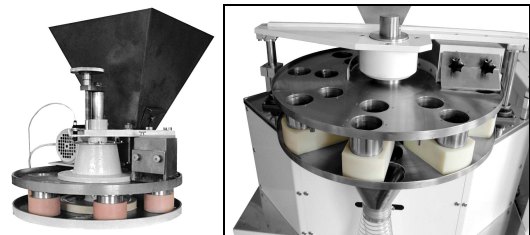

### Slide-valve dosers DS

- maximum output 60 doses per minute
- dose volume from 80 ml to 960 ml
- doser is suitable for dosing loose goods such as rice, coffee beans, peas, pasta, etc.
- dosers can be used on machines from other manufacturers





## Flow-pack packaging machines MH5

### What can you pack?

- dry products: sweets, tablets, chocolate and muesli bars, cookie, baguettes
- frozen products: ice cream
- adhesive products: cheeses, honey sticks
- the group of packed goods

### Package size

- width of packaged goods from 10 to 140 mm
- length of packaged goods from 26 to 450 mm
- height of the goods to 100 mm

### Packing capacity

- maximum speed 240 bags per minute
- performance is dependent on the size of the type of goods and packaging material



# Horizontal packaging machines

## Horizontal packaging machine

### PL1

#### What can you pack?

- loose goods
- dusty goods
- granulates
- small piece goods

#### Package size

- bags width from 80 mm to 220 mm
- bags height from 150 mm to 440 mm

#### Packing capacity

- maximum speed 20 bags per minute
- packing capacity depends on bag size, kind of goods and capacity of used filler

#### Types of bags

The machine is designed for packing into pre-made bags.

- pillow bags
- gusset bag
- bag with euro hole



## Horizontal packaging machine MH7

#### What can you pack?

- loose goods
- granulates
- small piece goods
- liquids

#### Package size

- bags width from 80 mm to 160 mm
- bags height from 120 mm to 300 mm

#### Packing capacity

- maximum speed 30 bags per minute
- packing capacity depends on bag size, kind of goods and capacity of used filler

#### Types of bags

The machine is designed for packing into pre-made bags.

- doypack
- pillow bags
- gusset bag
- bag with euro hole



## Dosing weighers AV2

### Dosing weighers AV2

- modular dosing weighers
- maximum output per one weighing module 30 doses per minute
- number of weighing modules from 1 to 8
- weighing range from 6 g to 5000 g
- dosing weighers are suitable for dosing granulates, bulk and small piece goods such as rice, pulses, coffee beans, pasta, dried fruits, herbs, tea, nuts, grated coconut, instant coffee, sweets, beads, chips, etc.
- dosing weighers can be applied to vertical packaging machines, or as a separate dosing unit to the line or as a manual dosing device
- weighers can be used on machines from other manufacturers
- possibility of extending to next weighing modules

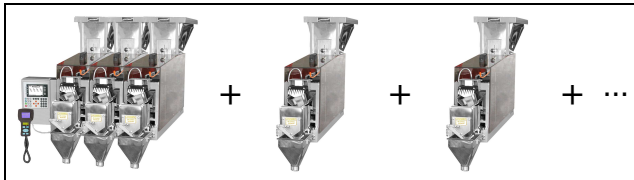
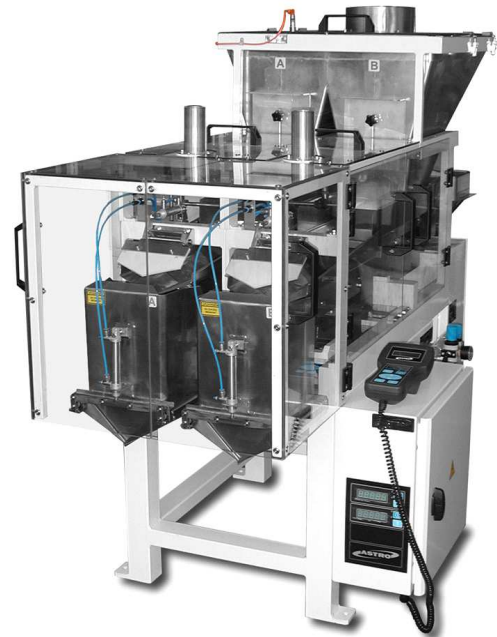

### Examples of the using of modular dosing weighers AV2



#### Manual dosing weigher AV2/1r

- one weighing lane
- dosing into prepare packaging, such as bags, cups, buckets, etc.



#### Two lanes weigher AV2/2

- weigher serves as a doser of goods which are subsequently packed hose vertical packaging machine
- two weighing lanes



#### Three lanes weigher AV2/3

- suitable for wet environment
- three weighing lanes
- appropriate for dosing of goods into dishes on the moving belt under the weighers



## Manual dosing devices

### Manual weighing device PES3

- device is suitable for dosing loose dusty goods into prepared bag
- capacity to 10 doses per minute
- weight of dose from 500 g to 30 kg



### Manual weighing device PES6

- device is suitable for dosing loose dustfree goods into prepared bag, bucket, etc.
- capacity to 6 doses per minute
- weight of dose from 500 g to 50 kg



### Manual weighing device PES7

- device is suitable for dosing loose dusty goods into prepared valve bag
- capacity 2 – 3 bags per minute
- dose weight do 50 kg



### Manual weighing device PES10

- device is suitable for dosing loose non-dusty goods into prepared bag or other packing
- capacity up to 6 doses per minute
- dose weight from 500 g to 50 kg



## Manual dosing devices

### Manual dosing weigher AV2/1r

- suitable for dosing loose goods into prepared bag, bucket, etc.
- capacity to 13 doses per minute (performance is dependent on operator skills)
- dose weight from 6 g to 5 kg



### Manual volumetric doser KL1r

- suitable for dosing loose goods into prepared bag, bucket, etc.
- capacity to 20 doses per minute (performance is dependent on operator skills)
- dose volume to 1840 ml



### Manual screw doser SD1r

- suitable for dosing loose goods into prepared bag, bucket, etc.
- capacity to 30 doses per minute (performance is dependent on operator skills)
- dose volume from 10 ml to 5 litres



### Manual weighing doser SD5r

- suitable for dosing loose goods into prepared bag or dose
- capacity to 15 doses per minute (performance is dependent on operator skills)
- dose weight from 90 g to 3 kg



# Automatic dosing machines

## Automatic dosing machine NP4

What can you pack?

- loose products
- granulates
- small piece goods

Types of packaging

- cylindrical glass packaging
- cylindrical plastic packaging
- wound cardboard packaging
- small tubs, buckets
- conical trays
- other similar standing packaging

Packaging capacity

- maximum capacity 40 pieces per minute
- packing capacity depends on used doser



## Automatic dosing machine NP5

What can you pack?

- loose products
- granulates
- small piece goods
- liquids, gels

Types of packaging

- cylindrical plastic packaging
- small pails, buckets
- conical trays
- other similar standing packaging

Packaging capacity

- maximum capacity up to 20 pieces per minute
- packing capacity depends on used doser

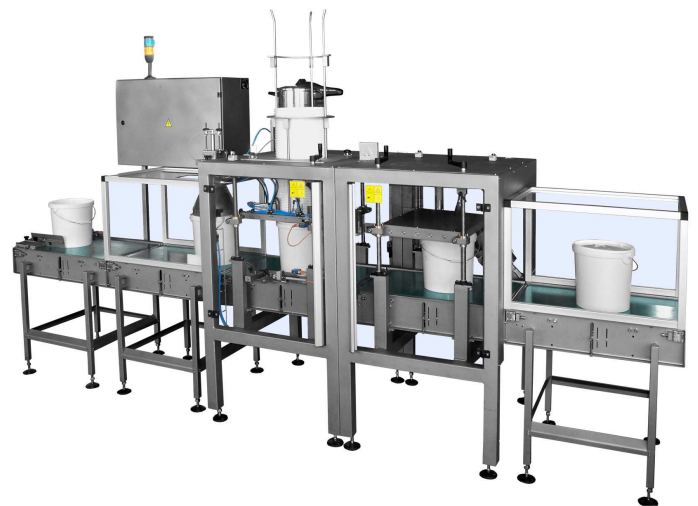

## Automatic dosing machines

### POLO NP1 + SD1

- feeding carrousel machine is designed for dosing of goods into solid cylindrical packaging
- machine is equipped with screw doser SD1 for dosing of dusty product
- capacity to 35 pieces per minute
- dose volume to 2,1 litres



### POLO NP1o + MD3 + OTV

- horizontal dosing and closing line for dosing of goods into solid packaging
- suitable for dosing loose non abrasive products
- capacity to 60 doses per minute
- dose volume to 1000 ml



### POLO NP2 + AV2/4

- horizontal dosing line for dosing products into solid packaging
- includes chamber with cup feeder, lids chamber and closing device
- machine is equipped with four flows dosing weigher AV2/4 for dosing loose goods
- capacity to 40 pieces per minute
- dose volume to 7 litres



### POLO NP1 + MV2/4

- horizontal dosing line
- suitable for dosing products into cups and their subsequent enclosure
- capacity to 40 pieces per minute
- dose volume to do 7 litres





## Conveyors

### Feeding conveyor VD1

- includes hopper
- feeding capacity 40 litres per minute
- different types of conveyor belts
- suitable for transporting loose goods



### Feeding conveyor VD3

- includes hopper
- feeding capacity 40 litres per minute
- different types of conveyor belts
- suitable for transporting loose goods



### Screw feeding conveyor VD5

- includes hopper
- feeding capacity 40 litres per minute
- suitable for transporting loose dusty goods



### Screw conveyor VD5 BigBag

- frame for catch of BigBag
- includes hopper
- feeding capacity 40 litres per minute
- suitable for transporting loose dusty goods



### Discharge conveyor OD4 250



### Discharge conveyor OD5



### Rotary collecting table OS2



### Discharge conveyor OD6



## Packaging lines

### Line for packing of loose soft curd MH2bb + AVS4 + VD1hl + OD4 + OS2

- complete packaging line is suitable for packing of loose soft curd into bags
- vertical form, fill and seal machine MH2bb, dosing device AVS4, feeding conveyor VD1hl, discharge conveyor OD4, rotary table OS2, service platform
- line capacity up to 35 bags per minute



### Packaging line MH2bb + BW114 + VD1z + OD4 + OS2

- complete packaging line is suitable for packing loose goods or granulates
- vertical form, fill and seal machine MH2bb, multi-head weigher BW11, feeding screw conveyor VD1z, discharge conveyor OD4, rotary table OS2, service platform
- line capacity up to 80 bags per minute



## Packaging lines

### Packaging line for melted chocolate icing into bags

- dosing is ensured by spindle liquid doser with double sheating to maintain a stable temperature of chocolate icing
- capacity to 7 bags per minute
- bag weight from 1 to 10 kg



### Packaging line for weighing dosing dusty goods

- dosing is ensured by covered dosing weigher
- capacity to 20 bags per minute
- bag weight from 100 g to 5 kg



### Packaging line MH1bb + AV2/4 + SD1

- multi-purpose design of the packaging line for packing dusty goods and small piece products
- capacity to 50 bags per minute
- dose volume from 10 ml to 2,5 litres



### SME

- horizontal large-volume packaging machine
- capacity to 4 bags per minute
- dose volume to 100 litres





## Packaging line BucketLine

### Line for dosing to buckets BucketLine

- line is suitable for packing loose goods and liquids to bucket
- line capacity to 14 buckets per minute
- maximum dose size to 15 kg (30 litres)

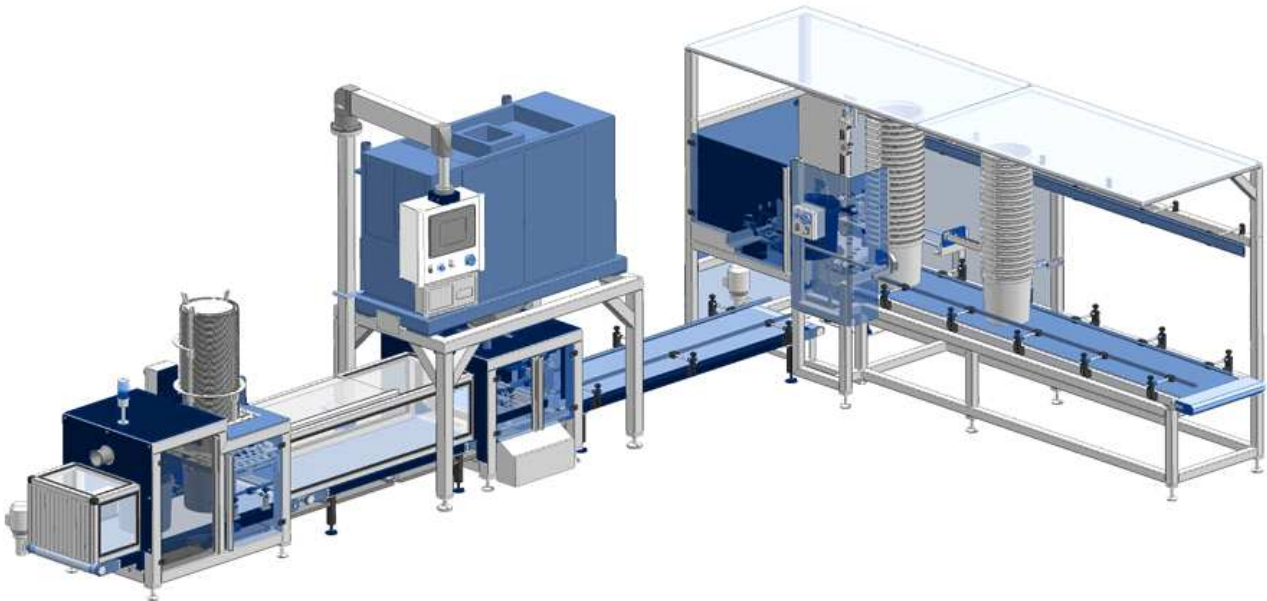

## Packaging machine with pressing LZ330-3G

- The machine is designed for pressing and packing of compressed goods in bags.
- The machine is suitable for the packing of paper blown insulation, cellulose, straw, hay, sawdust, shavings, waste and PET bottles.
- Packaging capacity up to 5 bags per minute, bag volume up to 80 liters





# BLEND LINE<sup>®</sup>

## line for preparation, mixing and packing of mixtures

High-performance automatic line is intended for dosing according to recipe, mixing and packing of loose blends for different types of usage. The amount of components is optional regarding a concrete project. The line is designed for very wide range of usage, e.g. for blending and packaging of food mixtures, chemical substrates, feed, building mixtures (cement mixtures etc.).

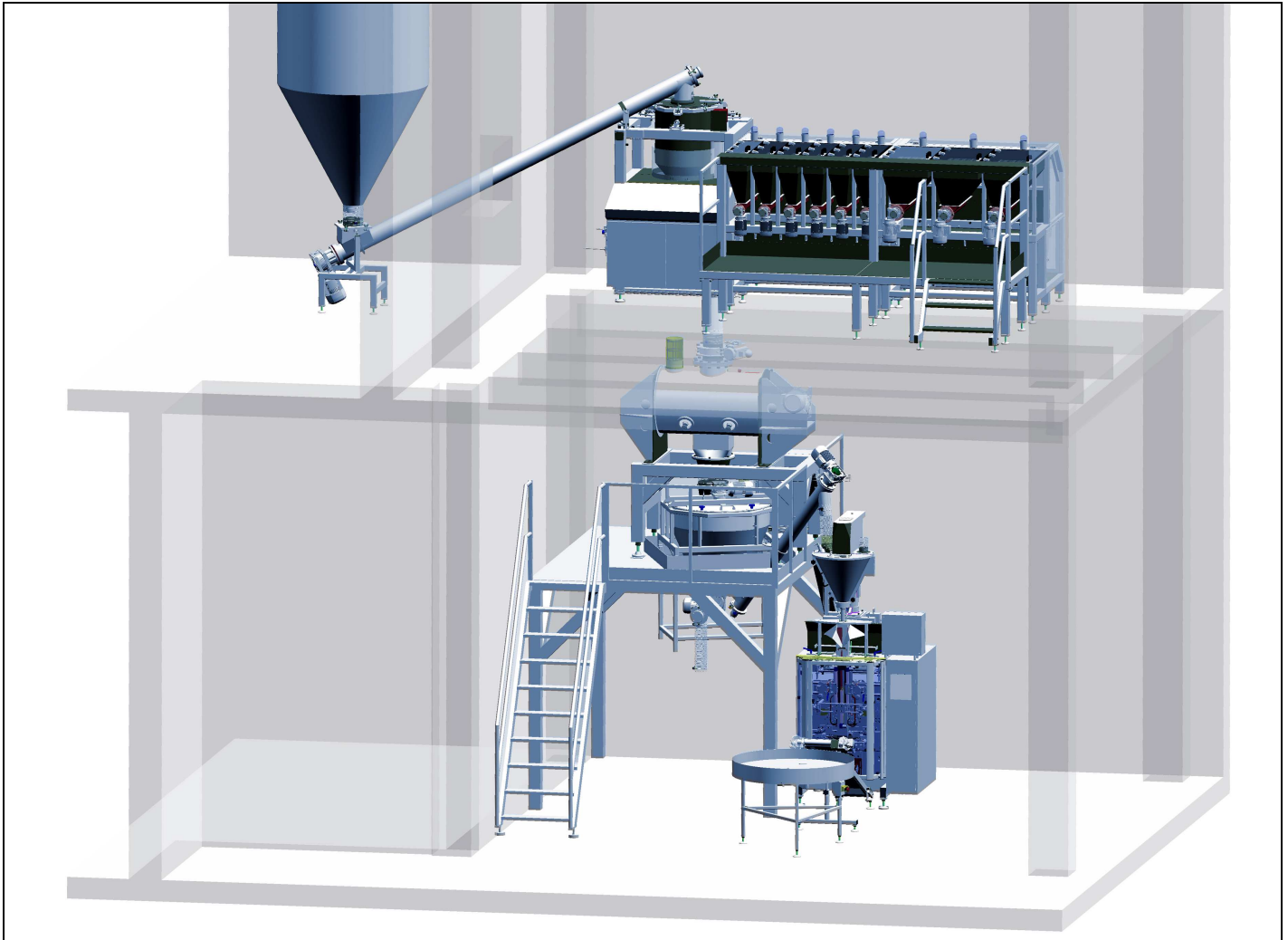

According to design of **dosing station** can be dosing any number of ingredients. Dosage provide digital dosing weighers with accurate  $\pm 1$  g.

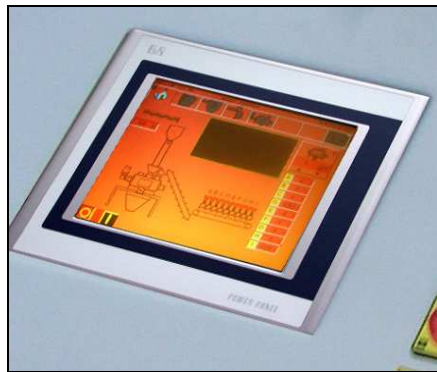

The **control system** allows quick and simple change of recipes. To memory can be saved up to 1000 recipes.



**Homogenizer** is suitable to mix all ingredients with an accuracy of mixing 1: 100 000.

## Components

### Dosing tubes with auger

- ASTRO Vlašim produces and supplies dosing tubes with auger destined for auger dosers of its own manufacture, but also for auger dosers of other producers.
- dosing tubes with auger are supplied with various types of closing according to handled product



### Potatoes cutter VD1-N2

- capacity up to 1400 kg per hour
- different shapes of cut – crescent, quaters

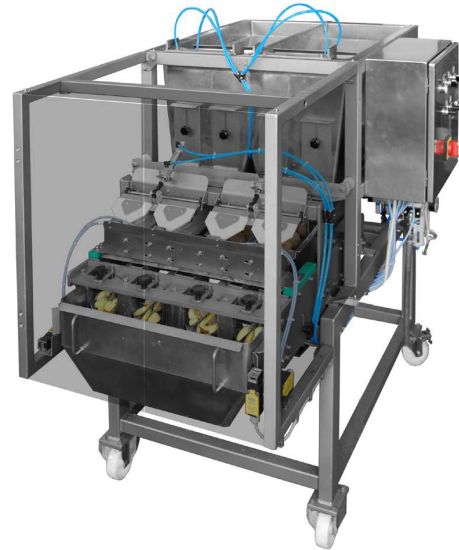

### Forming tubes and collars

- ASTRO Vlašim produces and supplies forming tubes with collar for vertical hose packaging machine of its own manufacture, but also for machines of other producers
- forming collars are designed with help of special computer program according to type of film and bag

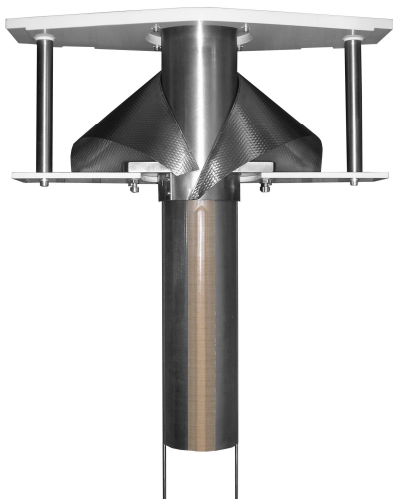

### Marking equipment

- marking equipment is developed for printing of data field on the foil through the stamping tape
- printing area size 40 x 60 mm

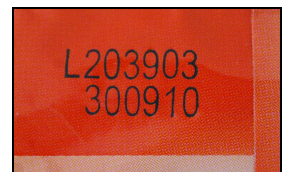
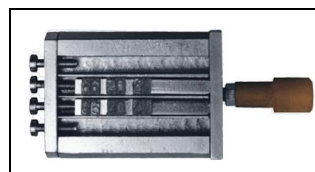
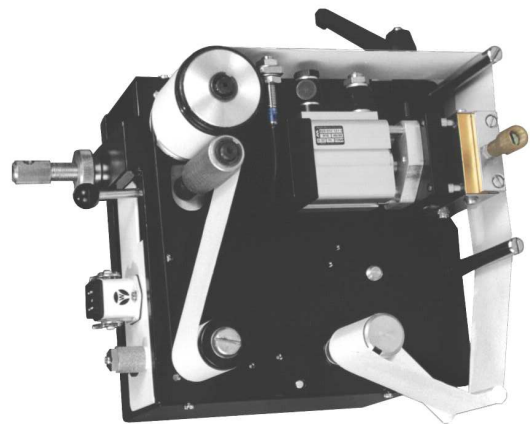

## Service

### Service

- service including consulting in the field on packaging is provided to you by high-skilled staff of company ASTRO Vlašim spol. s r.o.

# Bags overview

for packaging machines MH

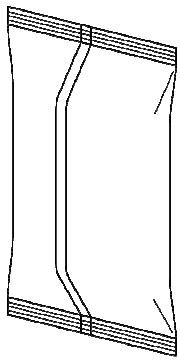

pillow bag

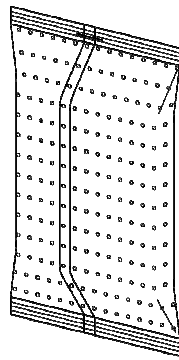

boiling bag

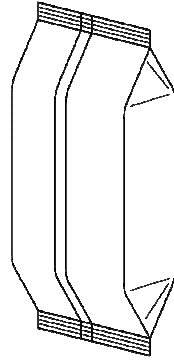

bag with breaking sides

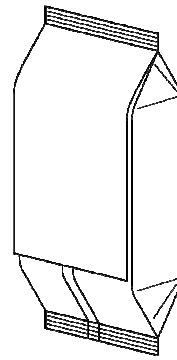

bag with pasteboard

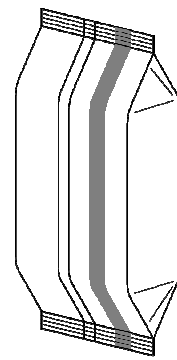

bag with glued advertisement strip

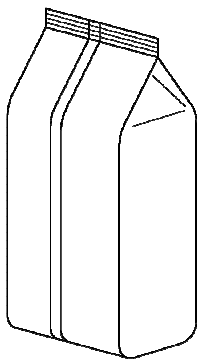

gusset bag

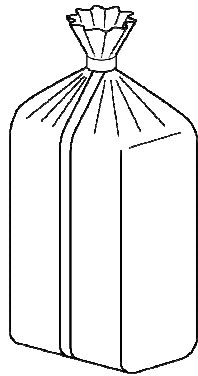

bag with flat bottom and clip for repeated closing

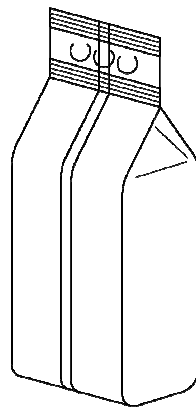

gusset bag with 3 holes for handling

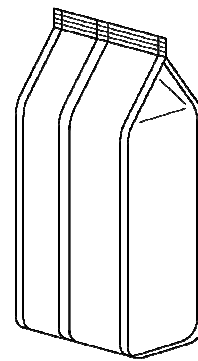

bag with welded edges

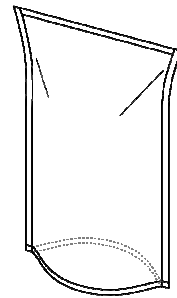

doy-pack

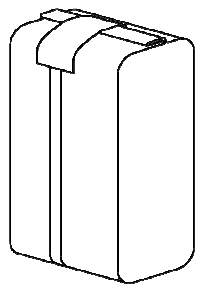

bag with folded bottom and top with label



stick-pack

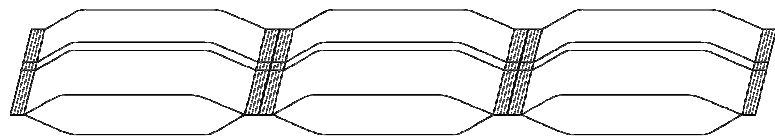

bags with perforation for easy stripping

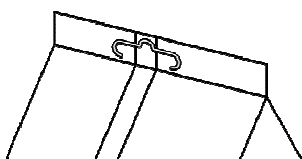

euro-hole

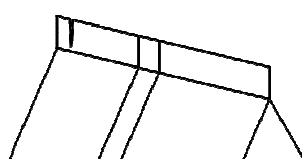

cutting for easy opening

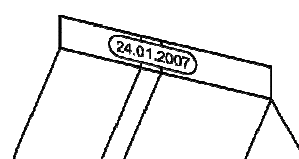

date in the weld

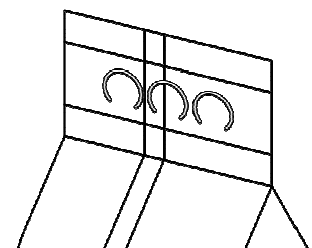

3 holes for easy handling

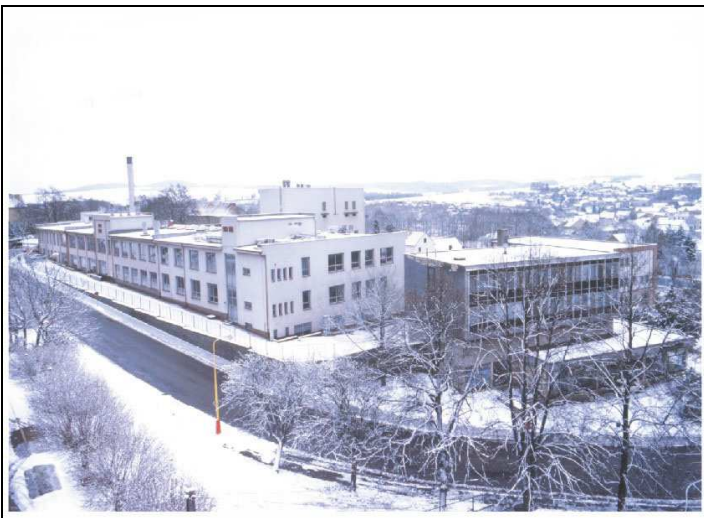

**ASTRO Vlašim spol. s r.o.**  
**Divišovská 328**  
**258 01 Vlašim**  
**Czech Republic**

**Tel. +420 317 843 813**  
**Fax +420 317 847 366**

**E-mail [astro@astro-vlasim.cz](mailto:astro@astro-vlasim.cz)**  
**<http://www.packaging.cz>**

