

Q.series

Manual

Q.bloxx



© 2017 Gantner Instruments GmbH

Operating instructions, manuals and software are protected by copyright. Copying, duplicating, translating, conversion into any electronic medium or into machine readable form, completely or partially, is only permissible with the expressed consent of Gantner Instruments GmbH. An exception is the making of a copy of software for one's own use for backup purposes, where this is technically possible and recommended by us. Infringements will be pursued in law and will be subject to compensation claims.

All trademarks and brand names used in this document only indicate the respective product or the proprietor of the trademark or brand name. The naming of products which are not from Gantner Instruments GmbH is made exclusively for informative purposes. Gantner Instruments GmbH makes no claims on trademarks or brand names other than its own.

Table of Contents

1	Safety Information	9
1.1	Intended use	9
1.2	Checking for damage in transit	9
1.3	Personnel	9
1.4	Special risks	10
1.5	Siting locations	10
1.6	Modifications.....	10
1.7	Servicing and cleaning.....	10
1.8	Disposal.....	11
1.9	General hazards due to non-observance of the safety information.....	11
2	Labels and warning information.....	13
2.1	Warning information	13
2.2	Labels on the modules	13
2.3	Labels in this manual	14
3	Introduction	15
3.1	The documentation in the Q.bloxx range.....	16
3.2	About this manual	16
3.3	System description.....	17
3.3.1	Operating the modules via Q.gate.....	17
3.3.2	Operating the modules via Q.pac	19
3.3.3	Operating the modules without Test Controller.....	20
4	Connecting the modules	21
4.1	Connecting the base	21
4.1.1	Hot swap (factory setting)	22
4.1.2	Setting the address (optional)	23
4.1.3	Activating the terminating resistances	24
4.1.4	Mounting/removing bases	25
4.1.5	Q.bloxx Extension Socket QES	26
4.2	Connecting the power supply	28
4.3	Fitting and removal of modules from bases.....	30
4.4	Connecting interfaces	31
4.4.1	Connecting modules to Q.gate	31
4.4.2	Connecting modules to Q.pac.....	32
4.4.3	Connecting Q.gate/Q.pac via Ethernet to a PC/PLC.....	34

4.4.4	Using the RS-232 interface of Q.gate or Q.pac	35
4.4.5	Connecting modules directly to a PC/PLC	36
4.5	Synchronization of several systems	38
4.5.1	Connection of a radio receiver for time signals.....	41
4.5.2	Connection of a GPS receiver	41
4.6	Module flashing frequency	42
4.6.1	SOS, configuration error	42
4.6.2	Firmware download	42
4.6.3	Activating the firmware download.....	42
4.6.4	Problems during data transmission	43
4.6.5	LED displays in normal operation.....	43
4.7	The modules and their connection options	44
4.8	Q.bloxx A101: Connecting sensors and I/O.....	46
4.8.1	Voltage	46
4.8.2	Current	47
4.8.3	Potentiometer	47
4.8.4	Resistance, Pt100, Pt1000	47
4.8.5	Thermocouple	48
4.8.6	Full and half-bridge transducers	48
4.8.7	Strain-gauge quarter bridges	49
4.8.8	IEPE/ICP [®] sensor	49
4.8.9	Digital input and output.....	50
4.9	Q.bloxx A102: Connecting sensors and I/O.....	51
4.9.1	Voltage.....	51
4.9.2	Current	52
4.9.3	Full and half-bridge transducers	52
4.9.4	Strain-gauge quarter bridges	53
4.9.5	IEPE/ICP [®] sensor	53
4.9.6	Analog output	53
4.9.7	Digital input and output.....	54
4.10	Q.bloxx A103: Connecting sensors and I/O.....	55
4.10.1	Voltage.....	55
4.10.2	Current	56
4.10.3	Digital input and output.....	56
4.11	Q.bloxx A104: Connecting sensors	57
4.11.1	Voltage.....	57
4.11.2	Thermocouple	58
4.12	Q.bloxx A105: Connecting sensors	59
4.12.1	Resistance, Pt100, Pt1000	59
4.13	Q.bloxx A106: Connecting sensors and I/O.....	61
4.13.1	Full and half-bridge transducers	61
4.13.2	Strain-gauge quarter bridge	62
4.13.3	Inductive full and half bridges	62
4.13.4	LVDT, RVDT.....	63

4.13.5	Analog output	63
4.13.6	Digital input and output	64
4.14	Q.bloxx A107: Connecting sensors	65
4.14.1	Voltage.....	65
4.14.2	Current	66
4.14.3	Potentiometer	66
4.14.4	Resistance, Pt100, Pt1000.....	66
4.14.5	Thermocouple.....	67
4.14.6	Full-bridge transducer.....	67
4.14.7	Strain-gauge half and quarter bridges	68
4.15	Q.bloxx A108: Connecting sensors and I/O.....	69
4.15.1	Voltage.....	69
4.15.2	Current	70
4.15.3	Digital input and output	70
4.16	Q.bloxx A109: Connecting I/O and outputs.....	71
4.16.1	Digital input and output, Plug 1	71
4.16.2	Analog output, Plug 2	72
4.17	Q.bloxx A111: Connecting sensors and I/O.....	73
4.17.1	Voltage.....	73
4.17.2	IEPE/ICP [®] Sensor	74
4.18	Q.bloxx A116: Connecting sensors	75
4.18.1	Full and half-bridge transducers	78
4.18.2	Strain-gauge quarter bridge.....	79
4.18.3	Activating the shunt resistance	81
4.19	Q.bloxx A123: Connecting sensors	83
4.19.1	Voltage.....	84
4.19.2	Current	84
4.20	Q.bloxx A124: Connecting sensors	85
4.20.1	Voltage.....	86
4.20.2	Thermocouple.....	86
4.21	Q.bloxx A127: Connecting sensors	87
4.21.1	Voltage.....	88
4.21.2	Current	88
4.22	Q.bloxx A128: Connecting sensors	89
4.22.1	Voltage.....	90
4.23	Q.bloxx D101: Connecting I/O	91
4.23.1	Digital input and output	91
4.24	Q.bloxx D104: connecting digital inputs.....	94
4.24.1	Digital input.....	94
4.25	Q.bloxx D105: connecting digital outputs.....	96
4.25.1	Digital output.....	96
4.26	Q.bloxx D107: Connecting digital inputs	97
4.26.1	Digital input.....	97

5	Configuration	101
5.1	Installing the test.commander	102
5.2	Using test.commander	103
5.2.1	Linking test.commander via Ethernet (TCP/IP)	103
5.2.2	test.commander and the serial (service) interface	105
5.2.3	Creating a project for configuration	106
5.3	Configuring analog inputs	107
5.3.1	Setting sensor parameters	107
5.3.2	Carrier frequency synchronization (Q.bloxx A106)	109
5.3.3	Zero balancing/taring the sensor	110
5.3.4	Sensor scaling over several points (table)	112
5.4	Specifying digital inputs/outputs	114
5.5	Configuring analog outputs	116
5.6	Defining computations	118
5.7	Specifying the alarm monitoring	119
5.8	Q.gate and Q.pac settings	121
5.8.1	Module interface	121
5.8.2	Host interface	122
5.8.3	Settings	122
5.8.4	Storage settings (only Q.pac)	125
5.8.5	System variable	125
5.8.6	Virtual variable	126
5.9	Online tools	129
5.9.1	Read data buffer (with measurements)	129
5.9.2	Displaying measurements	129
5.9.3	Reading module information	130
5.9.4	Reading status information	131
5.10	Firmware update	132
5.10.1	Firmware update for Test Controller	132
5.10.2	Firmware update for modules	133
6	Functional Procedures	135
6.1	Using serial interfaces	135
6.1.1	Interface converter	135
6.1.2	Bus termination on the Q.bloxx modules	136
6.1.3	Connection technology	136
6.1.4	Network topologies	137
6.2	Ethernet on the PC	138
6.2.1	Finding the IP address and subnet mask of the PC	138
6.2.2	Setting the IP address on the PC	139
6.2.3	Allowing access to network devices (firewall)	141
6.3	Connecting sensors with sensing leads	143

6.4	Sensor scaling	144
6.4.1	Scaling of voltage signals and strain-gauge bridges	144
6.4.2	Scaling strain gauges	145
6.5	Current measurement with an external shunt.....	147
6.6	Measuring with thermocouples	148
7	International Sales and Service	149

1

Safety Information

Before starting installation, setting up, operation and before maintenance work is carried out, it is essential to read and follow the appropriate warning and safety information given in this manual.

Installation, setting up, operation and maintenance of the modules or devices must take place as intended, i.e. under the conditions of use laid down in this manual and in the technical data for the relevant module or device.

1.1

Intended use

The products in the Q.series range are intended for use in industrial and experimental test engineering and for monitoring assembly and production processes. Transducers (sensors) for the acquisition of physical quantities such as voltage, current, resistance, temperature, force, displacement, torque, mass, strain and pressure can be connected. The modules are used exclusively for these kinds of measurement and control applications. Any application which goes beyond this scope does not fall within the intended use of the modules.

To ensure safe operation the modules and devices must only be operated according to the details given in the manuals and technical data sheets. In addition, the required legal and safety regulations covering the respective application must be followed. This applies in particular to the modules A123, A124, A127 and A128 with which input voltages of up to $1200V_{DC}$ are possible.

1.2

Checking for damage in transit

On receipt of the goods visually check that the packaging and the module or device together with the data medium are intact. Also check the shipment for completeness (accessory parts, documentation, auxiliary aids, etc.). If the packaging has been damaged in transit or if you suspect that the product is damaged or may malfunction, the product must not be put into operation. In this case contact your customer consultant or Gantner Instruments GmbH.

1.3

Personnel

The installation, operation and maintenance of the modules or devices must only be carried out by competent persons. Competent persons are those who through their professional education have sufficient knowledge in the required field and are familiar with the relevant national occupational protection regulations,

accident prevention regulations, guidelines and accepted engineering rules. They must be able to reliably assess the results of their work and must be familiar with the contents of this manual. Electrical connections must only be carried out by specialist personnel trained for the task.

In particular, pay attention to the following:

- the national installation and erection regulations (e.g. ÖVE, VDE, etc.)
- generally accepted engineering rules
- the details on transport, installation, operation, servicing, maintenance and disposal in this manual.
- the parameters, limits and the details about the operating and ambient conditions on the name-plates and in the data sheets.

1.4 Special risks

The modules A123, A124, A127 and A128 are specifically intended for measurements at high voltages. Consequently, on the modules a voltage of up to 1200 V may be present, which can lead to fatal or severe injury on touching the terminal contacts or bare parts of the connecting cables. Therefore, make sure that only qualified personnel have access to the modules or devices and that the voltages on modules can be switched off by a switch-disconnector or similar device for service purposes.

1.5 Siting locations

The devices in the Q.series range are protected to IP20 against water, dirt and small parts. If the ambient conditions require it, the modules can be fitted in water-protected or watertight housings.

Please note the admissible ambient temperatures specified in the technical data.

1.6 Modifications

Making modifications to the modules or devices is not permitted. Dirt and shrouding covers may only be removed for service and maintenance purposes.

1.7 Servicing and cleaning

The modules or devices do not need any servicing. Cleaning may only take place in the voltage-free state. Therefore follow the points below:

- Before cleaning, disconnect all connectors.
- Clean the housing with a soft, slightly moistened cloth. Never use any solvents, because these may attack the labels.
- When cleaning, make sure that no liquid enters into the device or goes onto the terminals.

Never attempt to repair nor to again operate devices which are defective, have developed a fault or are damaged. In this case it is essential to contact your customer consultant or Gantner Instruments GmbH.

1.8



Disposal

Old devices which are no longer usable must be disposed of according to national and local regulations regarding environmental protection and raw-material recycling. Electronic components must not be disposed of with the household refuse. The packaging can be recycled and should therefore be passed into the recycling system. However, we recommend that the packaging is kept until the end of the warranty period so that you can pack faulty devices or modules properly.

1.9

General hazards due to non-observance of the safety information

The modules or devices conform to the state of the art and are operationally safe. However residual risks may arise when they are used and operated improperly by untrained personnel.

Any person commissioned with the task of siting, operating, servicing or repairing a module or device in the Q.series must have read and understood the operating manual and in particular the information relating to safety.

2

Labels and warning information

2.1

Warning information

To prevent personal injury and damage to property it is essential that you follow the warning and safety information given in this operating manual.



Indicates a directly threatening hazard. If it is not prevented, the consequence will be fatal or serious injuries.



Indicates a possibly hazardous situation. If it is not prevented, the consequence may be fatal or serious injuries.



Indicates a possibly hazardous situation. If it is not prevented, the consequence may be injuries of slight or medium severity.

NOTICE

Indicates a situation in which the consequence may be property damage if the information is not followed.

2.2

Labels on the modules

Symbol: 

Meaning: This symbol is the CE marking. This shows that we guarantee that our product meets the requirements of the relevant EC directives.

Symbol: **CAT I, CAT II, CAT III**

Meaning: Modules with this symbol are intended for the connection of high voltage. The maximum admissible voltage is also given.

Symbol: 

Meaning: High voltage may be present on the module connections. Connection may only be made with the insulated connecting plugs provided.

2.3

Labels in this manual

To simplify reading this manual we use – along with the warning information given above – the following labels and notation:

IMPORTANT

Paragraphs with this symbol give important information about the product or about using the product.

Tip

Contains application hints and other particularly useful information.

Symbol: 

Meaning: Before connecting or disconnecting cables make sure that all sources of power are Locked Out.

<i>italics</i>	signifies highlighted text
interface	signifies entries and entry fields in program user interfaces
Options	indicates menu items in the program user interfaces
>	signifies a sequence of menu items, e.g. in Options > Settings
➡	indicates special features or restrictions

3

Introduction

Dear Customer,

Thank you for purchasing a product in the Q.series from Gantner Instruments GmbH. We are sure that you have obtained an excellent product which will enable you to make fast and reliable measurements with low measurement uncertainties.

If you find faults on the product or errors in the accompanying documentation or if you have suggestions for improvement, please contact your customer consultant or Gantner Instruments GmbH directly. We would be glad to receive your comments and ideas.

You will find further information in the section Technical Information in our Wiki at <https://dev.gantner-instruments.com/doku-wiki>. The user name is **support** and the password is **gins** (not all sections are open to the public).

Austria

Gantner Instruments GmbH
Montafonerstr. 4
6780 Schruns/Austria
Tel.: +43 (0) 5556 77463-0
Fax: +43 (0) 5556 77463-300
E-mail: office@gantner-instruments.com
Web: www.gantner-instruments.com

Germany

Gantner Instruments Test & Measurement GmbH
Heidelberger Landstr. 74
64297 Darmstadt
Tel.: +49 (0) 6151 95136-0
Fax: +49 (0) 6151 95136-26
E-mail: testing@gantner-instruments.com
Web: www.gantner-instruments.com

3.1

The documentation in the Q.bloxx range

The documentation for the Q.bloxx consists of this manual about the Q.bloxx modules A101, A102, A103, A104, A105, A106, A107, A108, A109, A111, A116, A123, A124, A127, A128, D101, D104, D105 and D107 as well as the Test Controllers Q.gate and Q.pac. Detailed descriptions on special settings for Q.gate and Q.pac or Q.station 101 can be found in other Gantner Instruments GmbH documentation on the Gantner CD or on our home page www.gantner-instruments.com.

You will find this manual also as a PDF file on our home page and on the Gantner CD enclosed with your module or which you can order free of charge from Gantner Instruments GmbH.

3.2

About this manual

This manual describes the installation, initial operation and the configuration of the modules Q.bloxx A101, A102, A103, A104, A105, A106, A107, A108, A109, A111, A116, A123, A124, A127, A128, D101, D104, D105 and D107 with the Test Controllers Q.gate and Q.pac using the program test.commander. The modules are differentiated through the number of their analog and/or digital inputs and outputs, by the maximum possible sample rate and the admissible input voltages.

The manual is divided into several chapters:

- Safety information in Chapter 1, ff. page 9.
- A description of the labels and symbols used on the modules and in this documentation can be found in Chapter 2 from page 13 onwards.
- You will find a description of the system and the main combination and expansion options in the next section.
- The description of the connection variants and the pin assignments on the inputs and outputs can be found in Chapter 4, *Connecting the modules*, ff. page 21.
- A comprehensive introduction to the configuration of the modules using the program test.commander is given in Chapter 5, *Configuration*, ff. page 101.
- Comprehensive explanation of the module measurement technology and background information about working procedures can be found in Chapter 6, *Functional Procedures*, ff. page 135.

3.3

System description

The modules in the Q.bloxx series have been developed for industrial and experimental measurement and test engineering, in particular for multi-channel measurements of electrical, mechanical and thermal signals on engine and component test-rigs as well as for monitoring processes and long-term supervision. The modules A123, A124, A127 and A128 are specially designed for measurements at high voltages.

 **DANGER**



Voltages of up to 1200 V may be present on the connections of the modules A123, A124, A127 and A128.

Before connecting or disconnecting cables make sure that all sources of power are Locked Out.

The individual modules can be combined to form one system as required. You can connect up to 32 or 64 modules to one of the Test Controllers Q.gate, Q.pac or Q.station 101 and then address them from a PC or PLC via a single interface. Alternatively, it is also possible to address single modules directly via the serial interface.

On all modules the power supply, bus interface and the inputs and outputs are electrically isolated from one another. The use with Q.gate and Q.pac is explained in this manual. Please use the manual provided specifically for this module when operating the Test Controller Q.station 101.

3.3.1

Operating the modules via Q.gate

You can connect up to 16 modules to each of the two serial interfaces (UARTs) of the Q.gate Test Controller (Fig. 3-1 and Fig. 3-2). For a direct connection on DIN mounting rails (DIN 35 mm rail according to DIN EN 60715) a special plug-on socket is also available: the Q.bloxx Extension Socket QES. This means that you can plug all 32 modules onto a mounting rail directly adjacent to one another. The Q.bloxx Extension Socket QES is plugged in centrally between the other sockets; the power supply of the second group of up to 16 modules also takes place through the extension socket.

You can communicate via Ethernet with the connected modules from the Q.gate Test Controller. The maximum cable length between the measurement modules and the Q.gate depends on the desired baud rate:

Cable length in meters	Maximum baud rate
1000	< 500 kBaud
100	< 1500 kBaud
20	< 6000 kBaud
10	>6 to 24 MBaud

You can insert the Q.gate Test Controller alternatively into the base to the left or right of the Q.bloxx modules (first or last base). Since the Q.gate Test Controller has a bus termination, it must be located on the end of the line and must not be positioned between the modules.

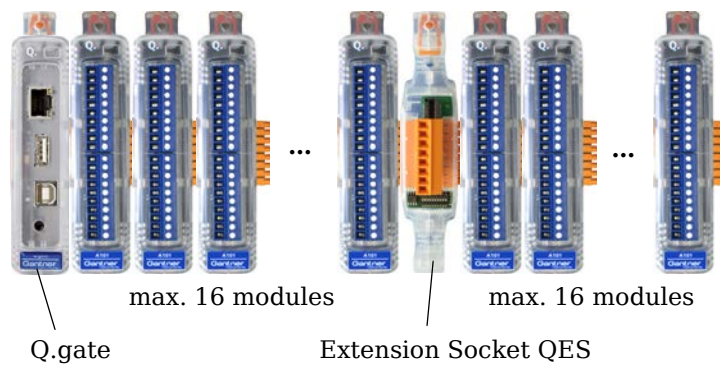

Fig. 3-1 Q.gate with up to 32 modules, connection via base and Q.bloxx Extension Socket QES.

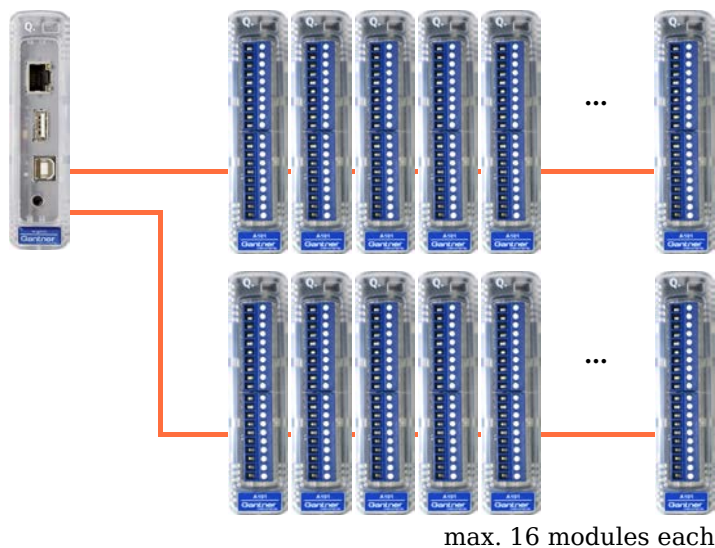

Fig. 3-2 Q.gate with up to 32 modules, connection via cables.

Depending on the operating mode of the modules, transmission rates of 1 kHz with up to 128 variables (transferred values with four byte resolution, real variables) are possible over Ethernet.

UART data throughput at 24 MBaud Sample rate 1 kHz Sample rate 10kHz Sample rate 100kHz	200 real variables 20 real variables 2 real variables
Ethernet data throughput (transmission rate with block transfer)	128 real variables (1 kHz) 16 real variables (10kHz)
Ethernet data throughput (transmission rate with online transfer)	64 real variables (300Hz)
Interfaces	Ethernet, USB, RS-232, 2 UARTs
Max. number of slaves (Q.bloxx)	32

3.3.2

Operating the modules via Q.pac

The Q.pac Test Controller is a programmable module with its own 128 Mbyte flash data memory and in addition it offers a graphically programmable PAC function. Optionally, EtherCAT is available as an additional interface with a data rate of up to 10 kHz.

You can connect up to 16 modules to each of the four serial interfaces (UARTs) of the Q.pac Test Controller (Fig. 3-3, page 20).

When using Ethernet, with Q.pac you can realize up to 16 variables (transferred values with four-byte resolution, real variable) at a sample rate of 10 kHz and with EtherCAT even 256 variables are possible at the same sample rate:

UART data throughput at 24 MBaud Sample rate 1 kHz Sample rate 10kHz Sample rate 100kHz	200 real variables 20 real variables 2 real variables
Ethernet data throughput (transmission rate with block transfer)	128 real variables (1 kHz) 16 real variables (10kHz)
Ethernet data throughput (transmission rate with online transfer)	128 real variables (300Hz)
EtherCAT data throughput (transmission rate)	256 real variables (10kHz)
Interfaces	Ethernet, EtherCAT, USB, RS-232, 4 UARTs
Max. number of slaves (Q.bloxx)	64

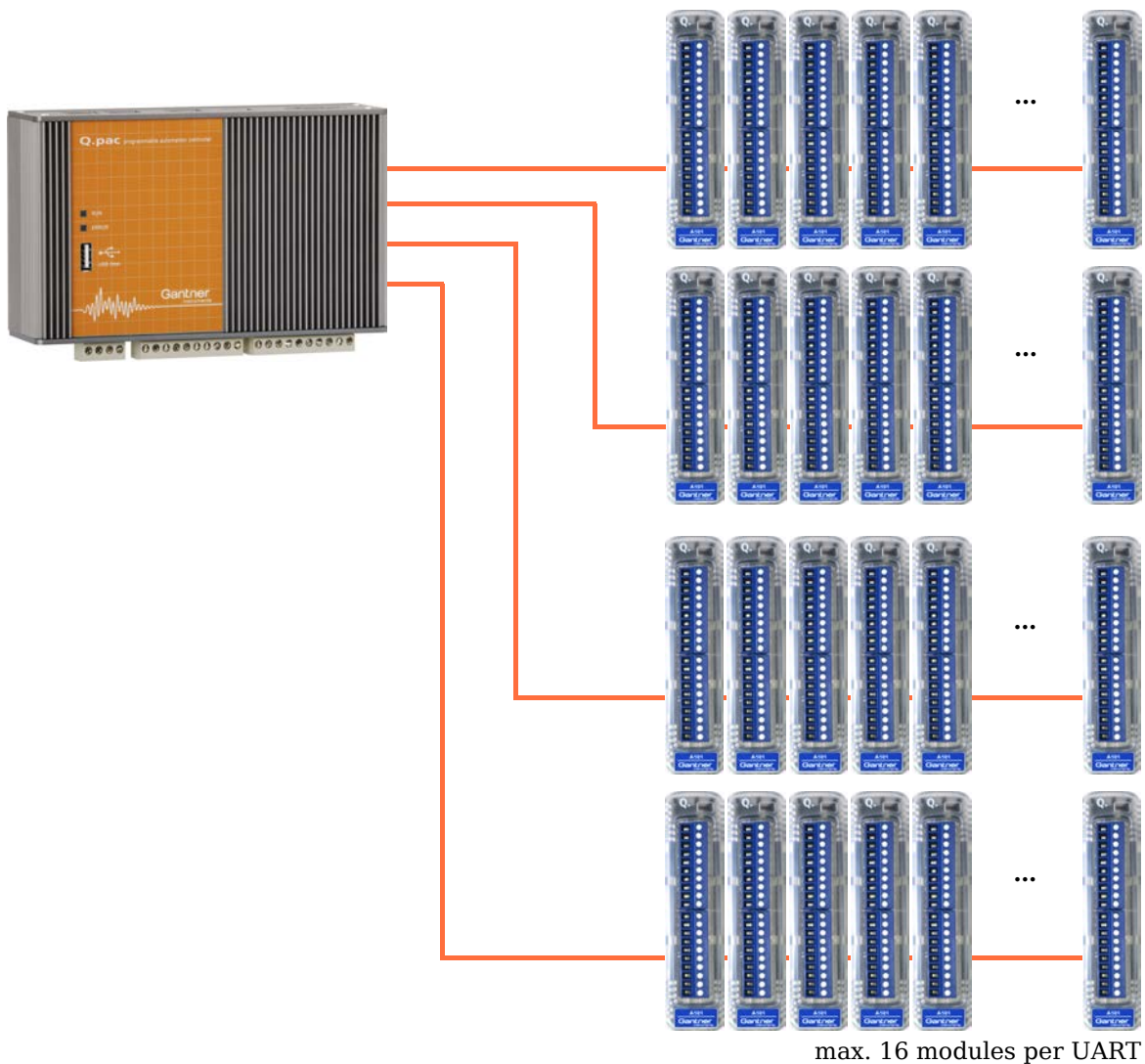

Fig. 3-3 Q.pac with up to 64 modules.

3.3.3

Operating the modules without Test Controller

You can connect the modules directly to a PC or PLC via the RS-485 interface on the modules. The following protocols are available:

- Gantner's own fast binary protocol. The configuration here takes place via the programs test.commander or ICP 100.
- Modbus RTU for reading and writing variables via registers.
- ASCII for reading and writing variables (values) with simple commands. Module configuration using the ASCII protocol is not possible.

4

Connecting the modules

This chapter contains the description of the connection variants and pin assignments.

4.1

Connecting the base

The base is used for supplying the current and voltage to the module, for synchronization and for the transfer of data. The module is also electrically connected to the mounting rail (DIN 35 mm rail according to DIN EN 60715) by means of a metal spring in the base. In addition, you can activate the terminating resistances for the interface at the end of the cable, save the module configuration in the base and define the restoration of this configuration when inserting a new module.

First, set the DIP switches in the base to the required position (4.1.2 to 4.1.3). Then plug the base on and push on further bases from the right (4.1.4). The power is supplied from the left side which also provides a direct connection to the PC or PLC if you are not using any Q.gate or Q.pac.

! IMPORTANT

The end of the interface line must be terminated with two resistances. Otherwise reflections occur on the line and lead to disturbances, even to the loss of data transmission. Refer to Section 4.1.3, *Activating the terminating resistances*, page 24.

You can operate the bases in various modes:

- Unconfigured, i.e. the modules are fully configured via a PC and software.
- With address configuration, i.e. the address of the modules is set via the base and all the rest of the configuration takes place via a PC. An address set by software is not taken into account in this case.
- With boot configuration (factory setting), i.e. a module can be replaced at any time by one of the same type (hot swap). The configuration data are saved in the base and are automatically loaded into the module when it is inserted. This means you can continue with your measurement without further configuration work. Saving the necessary data in the base occurs automatically via the configuration software test.commander.

Configuring the operating mode

The configuration of the operating mode occurs using the DIP switches in the base (Fig. 4-1). DIP switch 7 is currently not assigned any function and is reserved for later expansions.

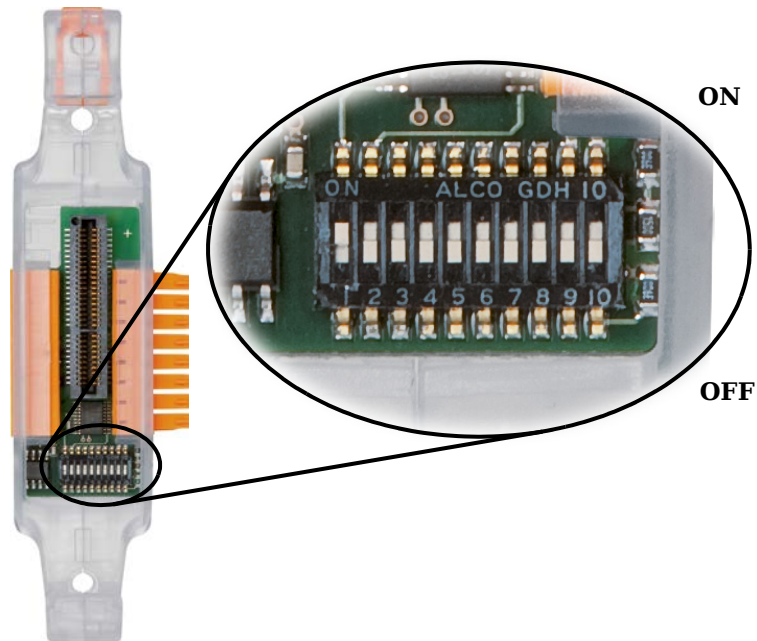

Fig. 4-1 DIP switches in the base, all DIP switches except the first one are OFF (address 1, hot swap activated).

4.1.1

Hot swap (factory setting)

Hot swap, i.e. the loading of the configuration from the socket EPROM (boot configuration), enables you to replace a defective module by one of the same type without having to carry out a configuration.

! **IMPORTANT**

If hot swap is activated (factory setting), any data in the module may be overwritten during insertion without prior confirmation.

If the socket contains no configuration or an incorrect module type is plugged onto the socket which does not match the stored configuration, this module flashes SOS:



Fig. 4-2 Flashing sequence with an incorrect module or when there are no settings in the socket. A short dash corresponds to a short flash, a long dash corresponds to a long flash.

After loading a valid configuration with the test.commander the module is ready for measurement and the configuration is also automatically set in the socket. During the next module replace-

ment the (new) module then reads the configuration from the socket EPROM and adjusts appropriately.

i Tip

With hot swap activated you should also set the address via the base (Section 4.1.2).

Push the DIP switch 8 upwards (ON, refer also to Fig. 4-1 on page 22) to deactivate hot swap. Any content present in the EPROM is not read in this case and the module configuration is used. After plug-in – once the module excitation is present – the module configuration is automatically transferred into the socket and saved, so that the same configuration is present in the socket as in the module.

Transferring the configuration to the base

When the configuration is changed via the test.commander program, the new configuration is automatically transferred to the base. In this way it is ensured that the same configuration is always present both in the base and in the module.

Replacing bases

1. You deactivate hot swap in the new socket as follows: Push DIP switch 8 upwards (ON).
2. Mount the new socket (Section 4.1.4, page 25) and switch the supply voltage on again.
3. Plug in the (old) module.
The module configuration is automatically transferred to the new socket (flashing LEDs).
4. Wait until the loading process has finished, i.e. until the LEDs no longer flash.
5. Withdraw the module again (Fig. 4-7, page 30).
6. Push DIP switch 8 downwards again to (OFF).
Next time the module is plugged in, the data will then be read from the socket again.

4.1.2**Setting the address (optional)**

The address is set in binary form with the first six switches. The address 0 corresponds to no configuration, i.e. an inserted module retains the address assigned via software. With new modules fresh from the factory you always have to assign an address, either via the DIP switch or via software, because otherwise several modules use the same address (default: 1) and are therefore not capable of measurement within a data bus; refer to

Chapter 5, *Configuration*, Section 5.2. Also for a configuration via the DIP switches an address set via the PC is retained in the module and is used again when the DIP switches are set to the address 0.

Address	S1	S2	S3	S4	S5	S6
0	OFF ¹	OFF	OFF	OFF	OFF	OFF
1	ON ¹	OFF	OFF	OFF	OFF	OFF
2	OFF	ON	OFF	OFF	OFF	OFF
3	ON	ON	OFF	OFF	OFF	OFF
4	OFF	OFF	ON	OFF	OFF	OFF
5	ON	OFF	ON	OFF	OFF	OFF
...
30	OFF	ON	ON	ON	ON	OFF
31	ON	ON	ON	ON	ON	OFF
32	OFF	OFF	OFF	OFF	OFF	ON

¹⁾ OFF = Switch down, ON = Switch up (Fig. 4-1)

The addresses 33 to 63 cannot be used via Q.gate or Q.pac. They are only available with the direct connection of a PC or a PLC; refer also to Section 4.4.5, *Connecting modules directly to a PC/PLC*.

- ➔ A base which is used to accommodate a Q.gate Test Controller requires no address.

4.1.3

Activating the terminating resistances

The terminating resistances must be activated on the *last* base of each interface line (and only there), because the end of the line must be terminated with two resistors (termination). Otherwise reflections occur on the line and lead to disturbances, even to the loss of data transmission.

- ➔ If the base is intended for accepting a Q.gate module, the terminating resistances must not be activated, because this module contains its own resistances.
 - Push the DIP switches 9 and 10 upwards to activate the terminating resistances (refer to Fig. 4-1 on page 22).

The resistances are only activated for the lines of UART 1A and UART 1B, because it is only these lines which are used by the modules. The lines for UART 2A and UART 2B are just passed on

by the bases and not used by the modules, so no terminating resistance is needed (no termination).

! IMPORTANT

The terminating resistances may only be activated at the end points of the interface line. If resistances are also activated in between, the signal is weakened and interference or even interruption of the data transmission occurs for the modules located after the additional resistances.

Terminating resistances and Q.bloxx Extension Socket QES

If you are using the Q.bloxx Extension Socket QES and have activated the bus crossover, you must activate the DIP switches in the socket directly *before* the extension socket *and* in the last socket *after* the extension socket (as viewed from the interface connection to the controller). In the socket before the extension socket the termination is made for the lines UART 1A and UART 1B which are then not used further. After the extension socket, due to the bus crossover, the lines for UART 2A and UART 2B, which were only routed further by the previous sockets, are located on the lines for UART 1A and UART 1B and are used for communication by the inserted modules. The termination must therefore occur at the end of the line in the last socket after the extension socket.

Refer also to Section 4.1.5, *Q.bloxx Extension Socket QES*, page 26.

4.1.4

Mounting/removing bases

- ➔ We recommend that the socket is only connected to the power supply after mounting (Section 4.2, page 28).

You can clip the base directly onto mounting rails (35 mm DIN rail according to DIN EN 60715): Hang the base over the upper part of the rail and then press it downwards until the latching cam locks in.

Then push the base onto any further existing bases to the left. There should be no intervening space between the bases, so press the right base firmly onto the left one.

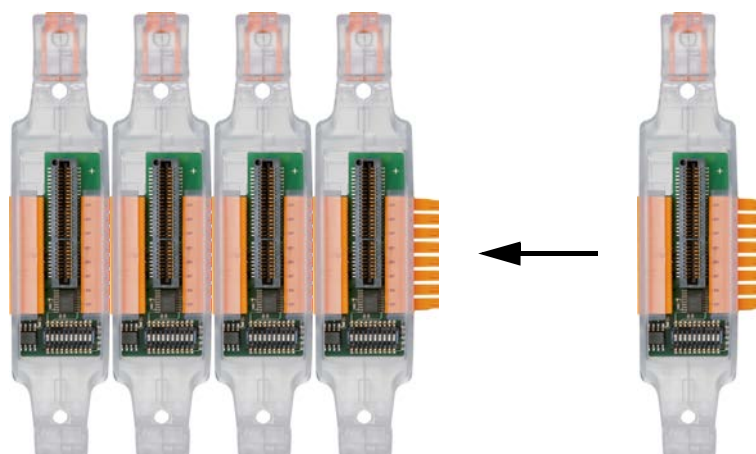

Fig. 4-3 Connecting several bases.

To remove, insert a narrow screwdriver into the hole at the lower end, press the screwdriver upwards on the handle to push the metal clip in the latching cam downwards and from below pull the base from the mounting rail to the front.

4.1.5

Q.bloxx Extension Socket QES

If you want to connect more than 16 modules, need a further feed for the supply voltage or want to spread modules over two bus interfaces, you need the Q.bloxx Extension Socket QES; modules inserted into the sockets only use the lines of UART 1. Since a maximum of 16 modules per bus interface is possible, with more modules you have to use UART 1 *and* UART 2.

With the extension socket you can additionally connect the modules arranged to the right of the socket to the lines of UART 2, i.e. the module crosses the lines of the two UARTs: The lines from UART 1 on the left side then go to the lines of UART 2 on the right side where they remain unused. The lines from UART 2 on the left side go to the lines of UART 1 on the right side and are used by the modules. Both UART interfaces are accessible via the extension socket and via the plug on the socket on the far left.

- ➔ All modules to the right of the extension socket can only be connected to the power supply via the plug in the extension socket, since there is no connection to the modules on the left side. All modules to the left of the extension socket must be supplied via the socket on the far left.

Using less than 16 modules

In this way you can use the Q.bloxx Extension Socket QES to

1. Obtain another feed point for the supply voltage.
2. Operate the modules with two interfaces in order to increase the data throughput.

The modules situated on the right of the extension socket are supplied by the extension socket and the modules located to the left must be supplied via the socket on the far left.

Crossing the UART lines is only necessary in the second case. The factory setting of the DIP switches is the 1:1 connection (i.e. with the interface lines directly connected), but check the setting of the DIP switches just to be sure.

Using more than 16 modules

The power supply must be routed via the socket situated on the far left as well as via the extension socket. The pin assignment is identical to the pin assignment for the side connection (Fig. 4-6, page 29). The DIP switches should be set to the crossover mode. You have four possible ways of connecting the interfaces.

1. You can use the connection on the socket on the far left.
In this way you can connect both interfaces if you interchange (cross) the UART lines via the DIP switches on the extension socket. This variant is, for example, suitable for the connection of a Q.pac Test Controller.
2. You can use a Q.gate Test Controller.
Plug the Q.gate Test Controller into the socket on the far left or far right and cross the UART lines using the DIP switches on the extension socket. The Test Controller then uses both UARTs for communication with the modules.
3. You connect the interface of UART 1 via a cable on the left socket and the interface of UART 2 on the Q.bloxx Extension Socket QES.
Also in this case you must cross the UART lines via the DIP switches on the extension socket, because the modules only use the lines of UART 1.
4. You connect both interfaces via cable to the Q.bloxx Extension Socket QES.
In this way you can connect both interfaces if you interchange (cross) the UART lines via the DIP switches on the extension socket. This variant is, for example, suitable for the connection of a Q.pac Test Controller.

DIP switch settings

The extension socket is operated in one of two modes depending on the application:

1. The interface lines are connected through 1:1 from left to right.

The DIP switches 1 to 4 are OFF and the DIP switches 5 to 8 are ON (factory setting).

2. The interface lines are crossed.

The DIP switches 1 to 4 are ON and the DIP switches 5 to 8 are OFF.

The DIP switches 9 and 10 (far right) have no function so their settings do not matter.

➔ Setting of all switches to OFF or all switches to ON is not admissible.

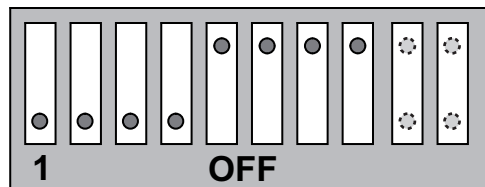

Fig. 4-4 The DIP switch position for a 1:1 connection (factory setting).

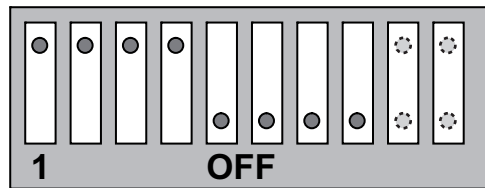

Fig. 4-5 The DIP switch position for crossed connection (interface lines for UART 1 and UART 2 are crossed).

4.2

Connecting the power supply

For the power supply an unregulated direct voltage between 10 and 30 volts is required, which is connected to the contacts 5 and 6 from above the base. Fig. 4-6 shows the pin assignment. Each module requires a power of approx. 2 W in addition to the power supplied for the connected transducers. The power required is almost constant over the complete voltage range.

Pin assignment	
	Sync A
	UART 2B
	UART 2A
	Sync B
	Supply +10 to 30 V _{DC}
	Supply 0 V
	UART 1B
	UART 1A

Fig. 4-6 Assignment for the base socket contacts (plan view).

! IMPORTANT

When the modules are switched on, there is an increase current demand until the modules are operating in a stable manner: In the start-up phase up to 700 mA (10 ms) per module is needed depending on the supply voltage. Thereafter, you should expect approx. 500 mA per module for a 10 V supply voltage, with a 30 V supply voltage approx. 170 mA. You should therefore either use power supplies which can deliver the required peak power when the voltage is switched on or - with many modules - switch the modules on in several groups.

The modules have an internal self-healing (reversible) fuse for protection against overvoltages, overcurrents and incorrect polarity.

- ➔ Do not use cable which is too thin for the connection so that the required power can be transferred to the module without significant losses.

The cable diameter, which can be connected to the terminals, is 0.14 mm² minimum and 1.5 mm² maximum or with wire-end sleeves without plastic sleeves 0.25 mm² and 1.5 mm² and with plastic sleeves between 0.25 mm² and 0.5 mm². In total no more than 16 modules should be supplied through their bases connected together. With more modules another supply line is necessary, for example via the Q.bloxx Extension Socket QES.

- ➔ The extension socket only supplies the module situated to the right of it and the modules located to the left of it require a power supply via the socket located on the far left.

4.3

Fitting and removal of modules from bases

Once you have mounted the bases, you can plug in the modules. To do this, hold the module so that it latches into the base latching cam below and then press it into the base with a slight rotary movement until the upper latching cam locks. Then press the orange-colored clip downwards (press lightly on the clip from above) to lock the module. Finally, check again that the module is correctly latched in the lower latching cam.

To remove a module from the base insert a narrow screwdriver through the hole in the upper latching cam and press the orange-colored clip in the latching cam upwards by pressing the screwdriver downwards (Fig. 4-7). Pull the module out to the front and downwards with a slight rotary movement.



Fig. 4-7 Removal of a module from the base.

4.4

Connecting interfaces

You have several options for communicating (configuration and data interchange) with the modules. You can:

- Connect the modules first to a Q.gate or Q.pac (Section 4.4.1 and Section 4.4.2, from page 31 onwards) and then connect to a PC or PLC via Ethernet (Section 4.4.3, page 34) or one of the optional field buses (EtherCAT, PROFIBUS-DP or CANopen). The configuration is carried out exclusively via the Ethernet interface.

For setting an IP address or for logging purposes you can also use the RS-232 interface of the Q.gate or Q.pac Test Controller (Section 4.4.4, page 35).

- Connect single modules directly to the PC or a PLC; refer to Section 4.4.5 from page 36 onwards.

For the serial interface cables use two-wire, twisted cables, with a screen if possible. Section 6.1, *Using serial interfaces*, page 135 provides comprehensive instructions for setting up serial interface links.

For Ethernet and EtherCAT we recommend the use of cables to Cat-5e or better.

The module baud rate set as shipped is 24 MBaud (factory setting). Depending on the length of the interface cable, you may have to reduce the speed of data transmission; refer to the following table. The overall length of the interface cable consists of the length of all cables between the individual modules and the cable length to the Test Controller or PC.

Cable length in meters	Maximum baud rate
1000	< 500 kBaud
100	< 1500 kBaud
20	< 6000 kBaud
10	>6 to 48 MBaud

4.4.1

Connecting modules to Q.gate

The Q.gate Test Controller can be inserted into a base just like a normal Q.bloxx module. However, only use the far left or far right base, because the module has integral terminating resistances and therefore terminates this end of the interface line. Any set base address is ignored by the Test Controller.

! **IMPORTANT**

Make sure that the terminating resistances at the (other) ends of the interface cables are activated. No resistances should be activated in the base of the Q.gate. They are permanently fitted in the Q.gate Test Controller and are always active.

Since the Q.bloxx modules plugged into the socket are only connected to the interface UART 1 on the socket, they appear in the Q.gate Test Controller only for UART 1. In order to be able to use UART 2 of the Test Controller you have to insert the Q.bloxx Extension Socket QES; refer to Section 4.1.5, page 26.

The interfaces of the Test Controllers to the PC or PLC are accessible at the front: Ethernet, USB and RS-232. You can in each case only use one of the Ethernet or USB interfaces at any one time. Currently however, the USB interface cannot be used. The RS-232 interface is used as a monitoring interface and is not suitable for the module configuration.

4.4.2

Connecting modules to Q.pac

The Q.pac Test Controller is inserted directly onto a mounting rail (35 mm DIN rail according to DIN EN 60715) and connected to the bases via cables and plugs. If you want to exploit the maximum number of 64 modules, you must connect each of all four serial interfaces (UARTs) of the Q.pac to 16 Q.bloxx modules. The sync lines are not needed and the synchronization takes place through the UART lines. In doing this pay attention to the maximum line length of the individual interface cables; refer to the table on page 31.

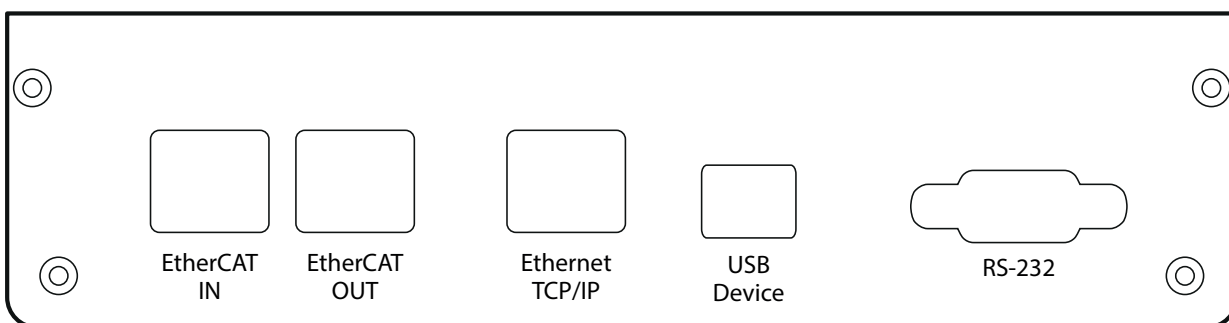

Fig. 4-8 Terminal arrangement on the Q.pac Test Controller (top).

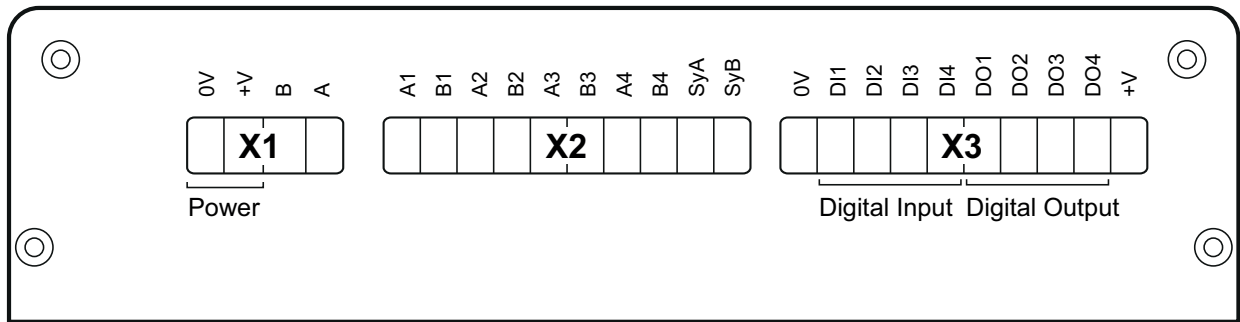

Fig. 4-9 Terminal arrangement on the Q.pac Test Controller (bottom).

Pin assignment for plug-in terminal X1

0V	0V, GND
+V	Supply voltage +10 to 30 V _{DC}
B	Interface RS-485 B
A	Interface RS-485 A

Pin assignment for plug-in terminal X2

A1	UART 1 A	Max. 16 modules
B1	UART 1 B	
A2	UART 2 A	Max. 16 modules
B2	UART 2 B	
A3	UART 3 A	Max. 16 modules
B3	UART 3 B	
A4	UART 4 A	Max. 16 modules
B4	UART 4 B	
SyA	Sync A	Input/output for synchronization, e.g. with another Test Controller
SyB	Sync B	

Pin assignment for plug-in terminal X3

0V	0V, GND
DI1	Digital Input 1
DI2	Digital Input 2
DI3	Digital Input 3
DI4	Digital Input 4
DO1	Digital Output 1

Pin assignment for plug-in terminal X3

DO2	Digital Output 2
DO3	Digital Output 3
DO4	Digital Output 4
+V	+10 to 30 V _{DC} for digital inputs/outputs

Fig. 4-10 Pin assignment for the plug-in terminals of the Q.pac Test Controller.

- ➔ If you want to use all four interfaces, then in each case with all four groups you must use the connection for UART 1 on the socket or insert the Q.bloxx Extension Socket QES to be able to use the interface lines for UART 2 available on the sockets. Refer to Section 4.1.5, *Q.bloxx Extension Socket QES*, page 26.

4.4.3

Connecting Q.gate/Q.pac via Ethernet to a PC/PLC

Both Q.gate and also Q.pac use DHCP (Dynamic Host Configuration Protocol) to obtain an address from a server in the network. In this case you only have to connect the module or the Test Controller to an Ethernet switch. An IP address is assigned automatically.

i Tip

We recommend the use of industrial Ethernet switches. Both Q.gate and Q.pac use autonegotiation and operate, if available, with 100 Mbit/s and full duplex for the transmission.

Connection without a server

If you are not connected to a network or there is no server in the network, you should set your PC to a fixed address in the range 192.168.1.x (**Control Panel > Network**) and connect to the Test Controller. If the Test Controller does not receive an IP address from a server, then it adjusts to its static IP address after a few seconds. The factory setting of the static IP address of the Test Controller is 192.168.1.28. Then set a suitable new address on the Test Controller and set your PC back to the original address, because otherwise you will not be able to establish any connection to the module.

i Tip

Refer also to Section 6.2, *Ethernet on the PC*, on page 138 for the display and setting of the PC IP address.

Connection in a network with a server

In the factory setting the Test Controllers use DHCP, i.e. they receive a valid network address from a server which is present in

the network. Connect the PC or the PLC to the same network. Then you can establish the link immediately via test.commander and can therefore also assign a fixed address to the Test Controller if required. Refer also to Section 6.2 on page 138.

Procedure

Setting an Ethernet address (IP address)

1. Make sure that the current version of the test.commander software is installed on your PC.
You will find the current version in the download section of our home page. If necessary, install the current version; refer to Section 5.1 on page 102.
2. Start the software.
3. Using the menu **Utilities > Controller network terminal** call the dialog for finding Test Controllers.
4. Click on **Configure IP settings**.
5. Select **Manually configure network settings** and specify the required IP address (**IP address**), the subnet mask (**Subnet mask**) and – if necessary – the gateway address (**Default gateway**). If in doubt, details can be obtained from your network administrator.
6. Click on **Apply** to accept the changes.

Example

Selected new IP address for the Test Controller: 192.168.169.85
Possible PC IP address: 192.168.169.10
Subnet masks of the PC and module: 255.255.255.0

Tip

Alternatively, you can also use the wizard for the initial operation in the test.commander program.

Section 6.2, *Ethernet on the PC* on page 138 contains further information about the use of Ethernet addresses and subnet masks.

4.4.4

Using the RS-232 interface of Q.gate or Q.pac

The RS-232 interface is used largely for the output of protocol information and for setting the IP address if this is not possible elsewhere. If required, a GPS device can also be connected to this interface; in this respect refer to Section 4.5.2, page 41.

The RS-232 interface of the Q.gate Test Controller is located below the USB interface at the front. For the link to a PC you require the supplied cable with the 3.5 mm stereo jack plug.

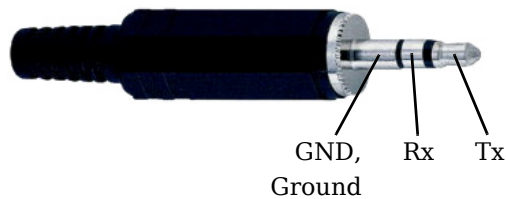

Fig. 4-11 Pin assignment for RS-232 on the jack plug.

The RS-232 interface of the Q.pac Test Controller is located on the underside (9-pole SUB-D socket with standard pin assignment).

Procedure

Setting an Ethernet address (IP address) via RS-232

1. Make sure that the current version of the test.commander software is installed on your PC.
You will find the current version in the download section of our home page. If necessary, install the current version; refer to Section 5.1 on page 102.
2. Start the software.
3. Using the menu **Utilities > Controller serial terminal** call the dialog for finding Test Controllers.
4. Specify the required IP address (**IP address**), the subnet mask (**Subnet mask**) and – if necessary – the gateway address (**Default gateway**). If in doubt, details can be obtained from your network administrator.
5. Click on **Apply** to accept the changes.

Example

Selected new IP address for the Test Controller: 192.168.169.85
Possible PC IP address: 192.168.169.10
Subnet masks of the PC and module: 255.255.255.0

Section 6.2, *Ethernet on the PC* on page 138 contains further information about the use of Ethernet addresses and subnet masks.

4.4.5

Connecting modules directly to a PC/PLC

You can connect modules directly to an RS-485 interface via the base connections UART 1A and UART 1B. The following protocols are available:

- The Gantner fast binary protocol for the programs ICP 100 and test.commander.
- Modbus RTU for reading and writing variables via registers.

- ASCII for reading and writing variables (values) with simple commands.

The modules switch automatically to the appropriate protocol.

! IMPORTANT

The modules cannot be directly connected to an RS-232 interface. Use an adapter if necessary for converting an RS-232 interface to RS-422 or RS-485, e.g. the interface converter ISK 101 from Gantner. Refer also to Section 6.1 on page 135.

Pin assignment



Sync A
UART 2B
UART 2A
Sync B
Supply +10 to 30 V _{DC}
Supply 0 V
UART 1B
UART 1A

Fig. 4-12 Assignment for the base socket contacts (plan view).

If you have connected more than 16 modules via the Q.bloxx Extension Socket QES, the second interface (UART 2A and UART 2B) is also occupied. For this however another RS-485 interface is required which you then connect to the appropriate contacts.

! IMPORTANT

Make sure that the terminating resistances are activated at the ends of the interface cables (refer also to Section 4.1.3 on page 24). With interfaces in the PC an active termination is often present, i.e. the interface automatically switches in the resistances as required. Check your interface documentation to find out whether this is the case.

4.4.5.1

Establishing connection with the test.commander setup wizard

1. Make sure that the current version of the test.commander software is installed on your PC.

You will find the current version in the download section of our home page. If necessary, install the current version; refer to Section 5.1 on page 102.

2. Start the software and select the **Utilities > Module setup assistant**
Another program window opens.
3. Select **Options > Communication settings**.
4. Under **Interface type** select the **RS-232 direct connection** and under **ComPort** the PC connection you are using.
5. Close the dialog with **OK**.
Further interface parameters are not needed.
6. Click on **Find modules**.
The program searches the specified interface for connected modules and displays all the modules found in the program window. If there are addressing conflicts, they are also displayed. Specify unique addresses for the modules; refer to Section 5.2 on page 103.

4.4.5.2

Establishing connection with ICP 100

1. Make sure that the current version of the ICP 100 software is installed on your PC.
You will find the current version in the download section of our home page. If necessary, install the current version; refer to Section 5.1 on page 102.
2. Start the software and select **Communication > Parameters**.
3. Under **Interface type** select the **RS-232 direct connection** and under **ComPort** the PC connection you are using.
4. Close the dialog with **OK**.
The program searches the specified interface for connected modules and displays all the modules found in the program window. If there are addressing conflicts, they are also displayed. Specify unique addresses for the modules; refer to Section 5.2 on page 103.

4.5

Synchronization of several systems

The synchronization of several interconnected Q.bloxx modules is ensured by the Test Controller. Both Q.gate and Q.pac ensure that all slave modules operate synchronously with the maximum jitter being approx. $\pm 2 \mu\text{s}$ over all modules.

You have various methods of obtaining synchronization, even with several *systems* (refer also to Fig. 4-13 on page 40):

1. Use the time signal in the Q.pac Test Controllers based on the IRIG standard (Inter Range Instrumentation Group) to synchronize all other Test Controllers to one master controller. The master controller (first device in the chain of devices) uses its internal clock for the date/time stamp (gray path in Fig. 4-13). For this type of synchronization you must lay synchronization lines between the Test Controllers; the maximum length of all lines together is 400m. The master controller transfers the time stamp through an RS-485 link to the other Test Controllers. This method achieves the best time synchronization with the smallest jitter (approx. $\pm 2 \mu\text{s}$) between the individual modules, because the time information passes simultaneously to all Test Controllers.

2. You connect a radio receiver for time signals, e.g. for DCF77 which converts the received time signal to IRIG-B, to a Q.pac Test Controller.

As master controller this then synchronizes all other Test Controllers using IRIG (orange colored path in Fig. 4-13) as with Variant 1. If it is not possible to connect the individual Test Controllers via synchronization lines or this is not desired, you can also connect a receiver to each Test Controller (Variant 2b).

3. You connect an NMEA-0183 compatible GPS receiver (Global Positioning System) to a Q.pac Test Controller, which then, similar to Variant 1, synchronizes as master controller all other Test Controllers.

With this method the time information of the GPS signal is evaluated instead of a pure time signal. In addition you can also process the position details of the GPS receiver in the system and assign the measurements (light blue path in Fig. 4-13). If it is not possible to connect the individual Test Controllers via synchronization lines or this is not desired, you can also connect a receiver to each Test Controller (also to Q.gate) (Variant 3b).

4. You define a PC as an SNTP time server which can distribute the NTP time stamp to all Q.gate or Q.pac Test Controllers (dark blue path in Fig. 4-13).

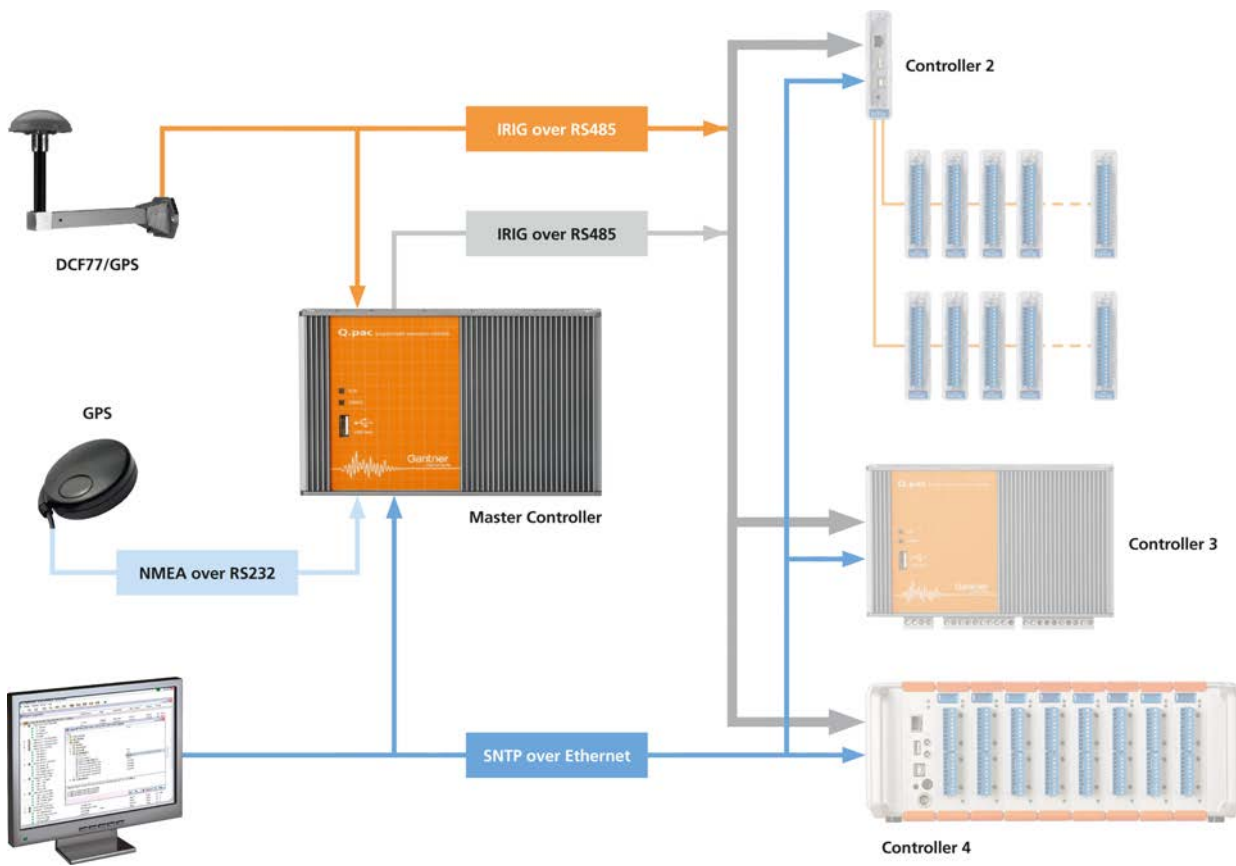

Fig. 4-13 Possible types of time synchronization.

The absolute accuracy of the time information depends on the method used. If you do not want to use or cannot use any time synchronization lines, e.g. because the spacing of the systems is too large, you must expect greater deviations. In Variant 2b the deviations are about 5 milliseconds depending on the receiver, but this depends on various factors, e.g. also on how often the time information is received. In the variant 3b the time accuracy of the GPS signal is decisive, which is only approx. 1 second absolute.

The fourth method uses, for example, the SNTP protocol (Simple Network Time Protocol) used in the Microsoft Windows operating system to transfer the date and time via Ethernet. However, the individual Test Controllers must always query the time server in order to be able to synchronize their times to the time server. The achievable accuracy is therefore not as good as for the three other methods. If required, you can also set up a (full) NTP time server on a PC and synchronize it with a time server in the Internet. You will find further information about this at <http://www.meinberg.de> (here you can also download a time server program) and at <http://www.pool.ntp.org>. The time accuracy then

only depends on the response times in your network, but here too it might amount to several milliseconds.

Configuration of the relevant method takes place using the `test.commander` program, see Section 5.8.3.3, *Synchronization*, page 123. If you combine several synchronization methods, the best possible one is always used from those available:

1. Hardware synchronization (synchronization of the Q.series, EtherCAT, IRIG-B or AFNOR using a time signal, e.g. DCF77)
2. Time signal from GPS (NMEA-0183)
3. SNTP

4.5.1

Connection of a radio receiver for time signals

Depending on the output signal of your receiver you basically have two methods:

1. The receiver, e.g. for DCF77, is connected to the digital IOs of the Q.pac Test Controller (plug-in terminal 1, connections 1 and 2; refer to Section 4.4.2, page 32). The variant is suitable if the receiver outputs signals at a TTL level.
2. The receiver is connected through the sync input (plug-in terminal 2, connections 9 and 10; refer to Section 4.4.2, page 32). The variant is only possible when the receiver has an RS-485 interface, because the sync input uses this interface.

The configuration is carried out using the program `test.commander` and the menu **Settings > Synchronization > Sync. settings. Protocol**; refer to Section 5.8.3.3, page 123.

4.5.2

Connection of a GPS receiver

NMEA-compatible GPS receivers normally have a serial interface and are therefore connected through RS-232 to the Test Controller. With Q.gate the RS-232 input at the front is used and with Q.pac the RS-232 input on the top side (next to the Ethernet connection).

The configuration is carried out using the program `test.commander` and the menu **Settings > Synchronization > Sync. settings. Protocol**; refer also to Section 5.8.3.3, page 123.

i Tip

Use the variable `GetPositioningData` to evaluate the individual data items of your GPS receiver.

4.6 Module flashing frequency

The modules have three LEDs: one blue LED on the upper edge and one red LED per connector strip. In normal operation the blue LED lights, but the red LEDs do not light. Depending on the error, the LED of the affected connector strip or the blue LED lights or all LEDs flash in a certain order. In the following illustrations a short dash corresponds to short flash and a long dash to a long flash.

4.6.1 SOS, configuration error

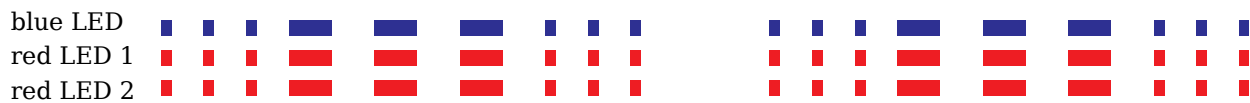

Fig. 4-14 Flashing sequence with an incorrect module or when there are no settings in the base.

Cause: The configuration saved in the base does not match that in the module.

There may be two reasons for this:

1. There is no configuration in the base yet.
2. The module type saved in the base configuration differs from the plugged-in module, therefore the configuration cannot be accepted.

Consequently, either change the module for the correct module type or reconfigure the module (Chapter 5, *Configuration*, page 101). The (new) configuration is then automatically saved in the base.

4.6.2 Firmware download

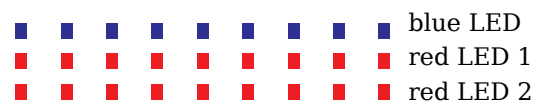

Fig. 4-15 Flashing sequence on downloading the module firmware.

The LEDs flash while the firmware download into the module is taking place.

4.6.3 Activating the firmware download

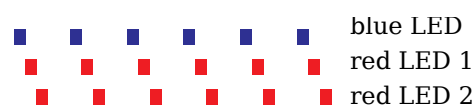

Fig. 4-16 Flashing sequence on activating the firmware.

The LEDs flash while the firmware is being configured after a download. After the download the module must be restarted.

4.6.4

Problems during data transmission



or



Fig. 4-17 Flashing sequence for problems during the data transmission.

These flashing sequences indicate a problem with the communication. Check the following:

1. Is the interface link between the modules in order (are the bases plugged together or connected to the cables correctly)?
2. Is the interface link between the modules and the Test Controller in order?
3. Is wiring of the interface connections correct?

Then restart the system (by switching off, waiting one minute and then switching on again). If these measures do not remedy the error, then contact your customer consultant or Gantner Instruments GmbH directly.

4.6.5

LED displays in normal operation

For modules with analog inputs a red illuminated LED indicates that the measurement range has been exceeded on at least one input. You can suppress this indication in the module configuration.

For modules with digital inputs or outputs an orange illuminated LED indicates that an input or output is active.

4.7

The modules and their connection options

Modules:	A 101	A 102	A 103	A 104	A 105	A 106	A 107	A 108	A 109	A 111	A 116
Signal inputs											
Voltage	X	X	X	X			X	X		X	
Current	X	X	X				X	X			
Potentiometer	X						X				
Resistance	X				X		X				
Pt100, Pt1000	X				X		X				
Thermocouple	X			X			X				
(Strain gauges) full + half bridge	X	X				X	X ¹⁾				X
Strain-gauge quarter bridge	X ²⁾	X ²⁾				X ²⁾	X ²⁾				X
Inductive full and half bridge						X					
LVDT, RVDT						X					
IEPE/ICP [®] Sensor	X	X								X	
Digital input: frequency, pulse width, counter									X		
Digital input: Status	X	X	X			X		X	X		
Signal outputs											
Voltage		X				X			X		
Current		X							X		
Digital output: frequency, pulse width									X		
Digital output: Status	X	X	X			X		X	X		
Number of channels	2	1	8	8	4	2	4	8	4	4	8
Data rate (in Hz)	100k	100k	100	100	10	10k	10k	10k	100k	100k	10k
For description refer to page	46	51	55	57	59	61	65	69	71	73	75

1) Half bridge only with Q.bloxx Terminal

2) Quarter bridge with Q.bloxx Terminal

Modules:	A 123	A 124	A 127	A 128	D 101	D 104	D 105	D 107
Signal inputs								
Voltage	X	X	X	X				
Current								
Potentiometer								
Resistance								
Pt100, Pt1000								
Thermocouple		X						
(Strain gauges) full + half bridge								
Strain-gauge quarter bridge								
Inductive full and half bridge								
LVDT, RVDT								
IEPE/ICP [®] Sensor								
Digital input: frequency, pulse width, counter					X			X
Digital input: Status					X	X		X
Signal outputs								
Voltage								
Current								
Digital output: frequency, pulse width					X			
Digital output: Status					X		X	
Number of channels	4	4	4	4	8	16	16	6
Data rate (in Hz)	100k	10k	100k	100k	up to 100k	10k	10k	1M
For description refer to page	83	85	87	89	91	94	96	97

4.8

Q.bloxx A101: Connecting sensors and I/O

The Q.bloxx Module A101 has two electrically isolated analog inputs and two digital inputs or outputs. The pin assignment of the two connector strips is identical and the connection terminals have numbers for identifying the connections.

GND identifies the measurement ground of an input, 0 V and +V refer to the (external) supply voltage connections. Measurement ground and (module) supply voltage are electrically isolated in the module.

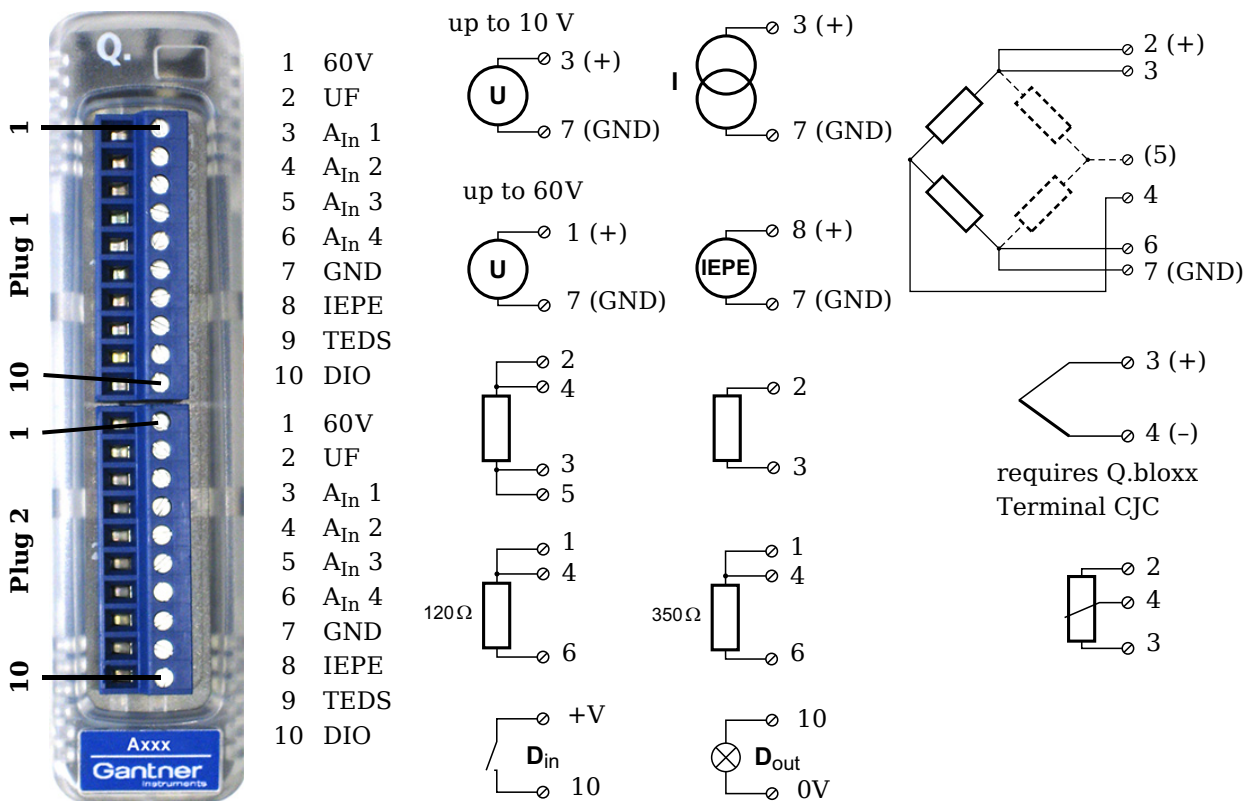

Fig. 4-18 Pin assignment for Q.bloxx Module A101.

i Tip

Further information on transducers and sensors can also be found in Chapter 6 ff. page 135.

4.8.1

Voltage

With voltage measurements two connection variants are possible, depending on the level of the voltages to be measured: up to 10V and up to 60V.

! IMPORTANT

Voltages which exceed the admissible limits produce incorrect measurement data, because the inputs are protected against overvoltages and limit the input voltage.

Voltages up to 10V**Voltages up to 60V**

Fig. 4-19 A101, measurement of voltage.

4.8.2**Current**

A shunt resistance of 50Ω is integrated into the Q.bloxx Module A101 for current measurement. This facilitates the measurement of currents of up to 25mA. For higher currents use a voltage measurement and an external shunt; refer to Section 6.5, page 147.

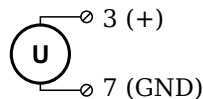
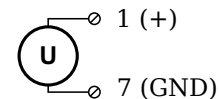
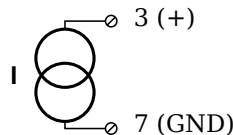

Fig. 4-20 A101, measurement of current.

4.8.3**Potentiometer**

Potentiometers with resistances between $1\text{ k}\Omega$ and $10\text{ k}\Omega$ are connected in a three-wire configuration.

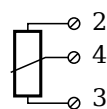
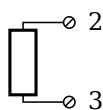

Fig. 4-21 A101, measurement with potentiometers.

4.8.4**Resistance, Pt100, Pt1000**

You can connect resistances and Pt100/1000 probes in two-wire or four-wire circuits. You specify the selected type of circuit during the module configuration (**Type** column).

2-wire circuit



4-wire circuit

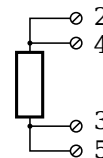

Fig. 4-22 A101, measurement of resistance and Pt100/1000 probes.

i Tip

Information about the types of circuit and the respective advantages and disadvantages can be found in Section 6.3, *Connecting sensors with sensing leads*, page 143.

4.8.5

Thermocouple

For connecting thermocouples you need a special connecting plug which contains the comparative measuring point (cold point compensation) required for thermocouples. The plug can be obtained under the designation Q.bloxx Terminal CJC-A101 from Gantner Instruments GmbH. You can connect the following types of thermocouple: B, E, J, K, L, N, R, S, T and U.

Alternatively, you can also use two thermocouples or a reference temperature source.

i Tip

You will find information on the comparative measuring point and on the measurement with a reference temperature source in Section 6.6, *Measuring with thermocouples*, page 148.

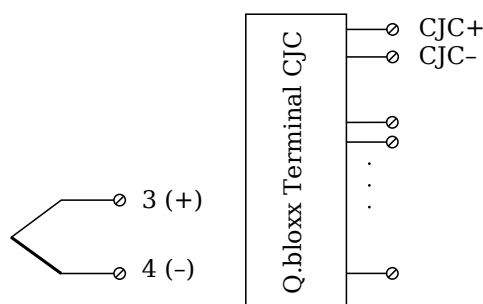

Fig. 4-23 A101, measurement with thermocouple using Q.bloxx Terminal CJC-A101.

4.8.6

Full and half-bridge transducers

With (resistive) full bridges (strain-gauge full bridges) all connections are occupied. If the sensor has no sensing leads, you specify this during the module configuration (**Type** column). With half

bridges the side drawn in dashes and the connection 5 are omitted.

The bridge excitation voltage is 2.5V.

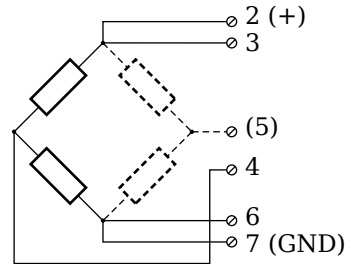

Fig. 4-24 A101, measurement with full and half bridges.

i Tip

Information about the types of circuit and the respective advantages and disadvantages can be found in Section 6.3, *Connecting sensors with sensing leads*, page 143.

4.8.7

Strain-gauge quarter bridges

For the connection of strain-gauge quarter bridges you need a special connecting plug which contains the completion resistances. The plug can be obtained under the designation Q.bloxx Terminal B4/120-A101 with 120Ω or B4/350-A101 with 350Ω from Gantner Instruments GmbH.

The bridge excitation voltage is 2.5V.

! IMPORTANT

The plug must have the same resistance values as the strain gauges used, because otherwise no measurement is possible. Since, for reasons of stability, all necessary completion resistances are located in the Q.bloxx Terminal, you have to select a full bridge circuit as the bridge type for the channel.

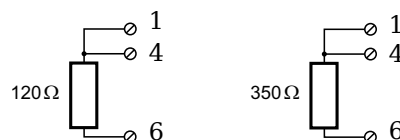

Fig. 4-25 A101, measurement with strain-gauge quarter bridge using Q.bloxx Terminal B4.

4.8.8

IEPE/ICP[®] sensor

The sensor is supplied with 4mA of current from the module (current supply).

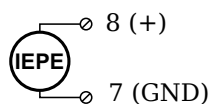

Fig. 4-26 A101, measurement with IEPE or ICP® sensors.

4.8.9

Digital input and output

On each connecting plug a contact is available for an input or output. You can use the appropriate function depending on the wiring.



Fig. 4-27 A101, digital input and output.

The digital input is active (high level) when the applied signal voltage lies above the threshold of 10V.

4.9

Q.bloxx A102: Connecting sensors and I/O

The Q.bloxx Module A102 has one electrically isolated analog input, one analog output and two digital inputs or outputs electrically isolated from the analog section. The assignment of both connector strips is *not* identical. The plug number is specified in the following. The connection terminals have numbers for identifying the connections.

GND identifies the measurement ground of an input, 0 V and +V refer to the (external) supply voltage connections. Measurement ground and (module) supply voltage are electrically isolated in the module.

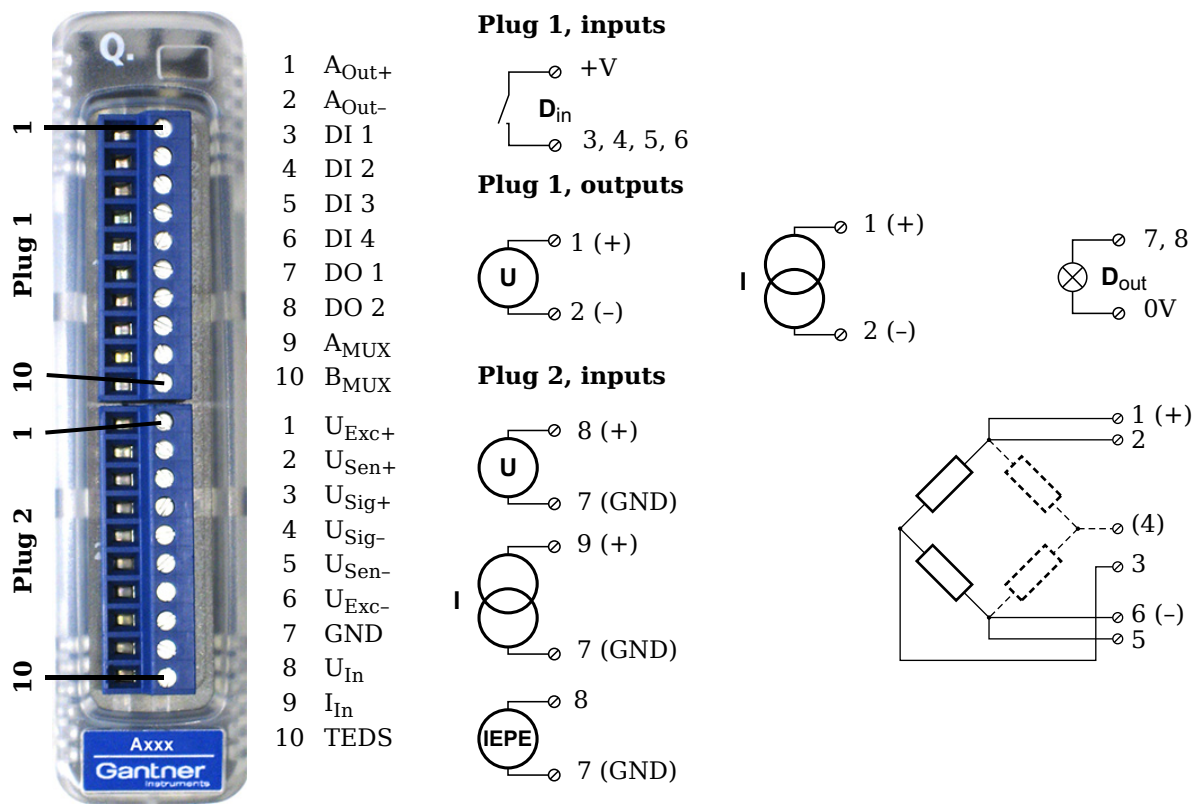

Fig. 4-28 Pin assignment for Q.bloxx Module A102.

i Tip
Further information on transducers and sensors can also be found in Chapter 6 ff. page 135.

4.9.1

Voltage

You can measure voltages of up to 10V via Plug 2.

! **IMPORTANT**

Voltages which exceed the admissible limits produce incorrect measurement data, because the inputs are protected against overvoltages and limit the input voltage.

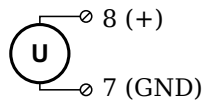

Fig. 4-29 A102, measurement of voltage, Plug 2.

4.9.2

Current

A shunt resistance of 50Ω is integrated into the Q.bloxx Module A102 for current measurement. This facilitates the measurement of currents of up to 25 mA via Plug 2. For higher currents use a voltage measurement and an external shunt; refer to Section 6.5, page 147.

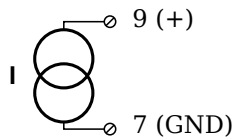

Fig. 4-30 A102, measurement of current, Plug 2.

4.9.3

Full and half-bridge transducers

With (resistive) full bridges (strain-gauge full bridges) all connections are occupied. If the sensor has no sensing leads, you specify this during the module configuration (**Type** column). With half bridges the side drawn in dashes and the connection 4 are omitted.

The bridge excitation voltage is switched via software between 1V, 2.5V, 5V and 10V.

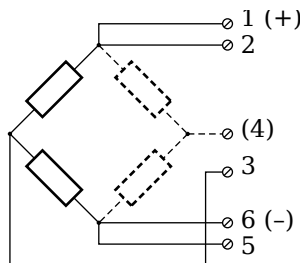

Fig. 4-31 A102, measurement with full and half bridges, Plug 2.

i Tip

Information about the types of circuit and the respective advantages and disadvantages can be found in Section 6.3, *Connecting sensors with sensing leads*, page 143.

4.9.4**Strain-gauge quarter bridges**

For the connection of strain-gauge quarter bridges you need a special connecting plug which contains the completion resistances. The plug can be obtained under the designation Q.bloxx Terminal B4/120-A102 with 120Ω or B4/350-A102 with 350Ω from Gantner Instruments GmbH.

The bridge excitation voltage is switched via software between 1V, 2.5V, 5V and 10V.

! IMPORTANT

The plug must have the same resistance values as the strain gauges used, because otherwise no measurement is possible. Since, for reasons of stability, all necessary completion resistances are located in the , you have to select a full bridge circuit as the bridge type for the channel.

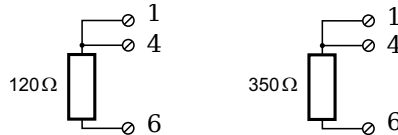

Fig. 4-32 A102, measurement with strain-gauge quarter bridge using Q.bloxx Terminal B4 on Plug 2.

4.9.5**IEPE/ICP[®] sensor**

The sensor is supplied with 4mA of current from the module (current supply).

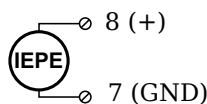

Fig. 4-33 A102, measurement with IEPE and ICP[®] sensors, Plug 2.

4.9.6**Analog output**

An analog output for voltage or current is available on Plug 1. The selection between voltage and current is made via software.



Fig. 4-34 A102, output of voltage or current, Plug 1.

4.9.7

Digital input and output

Contacts for four inputs and two outputs are available on Plug 1.

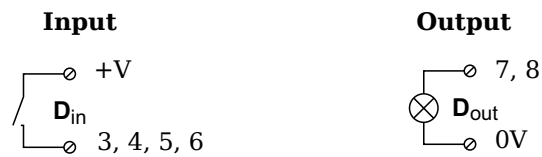

Fig. 4-35 A102, digital input and output, Plug 1.

The digital input is active (high level) when the applied signal voltage lies above the threshold of 10V.

4.10

Q.bloxx A103: Connecting sensors and I/O

The Q.bloxx Module A103 has eight electrically isolated analog inputs and two digital inputs and outputs. The pin assignment of the two connector strips is identical and the connection terminals have numbers for identifying the connections. You will find the associated figures in each case at the same place in the circuit diagrams, for example each of the figures quoted in the second place belong to one possible connection method.

The designations 0 V and +V refer to the (external) supply voltage connections. Measurement ground (-) and the (module) supply voltage are electrically isolated in the module.

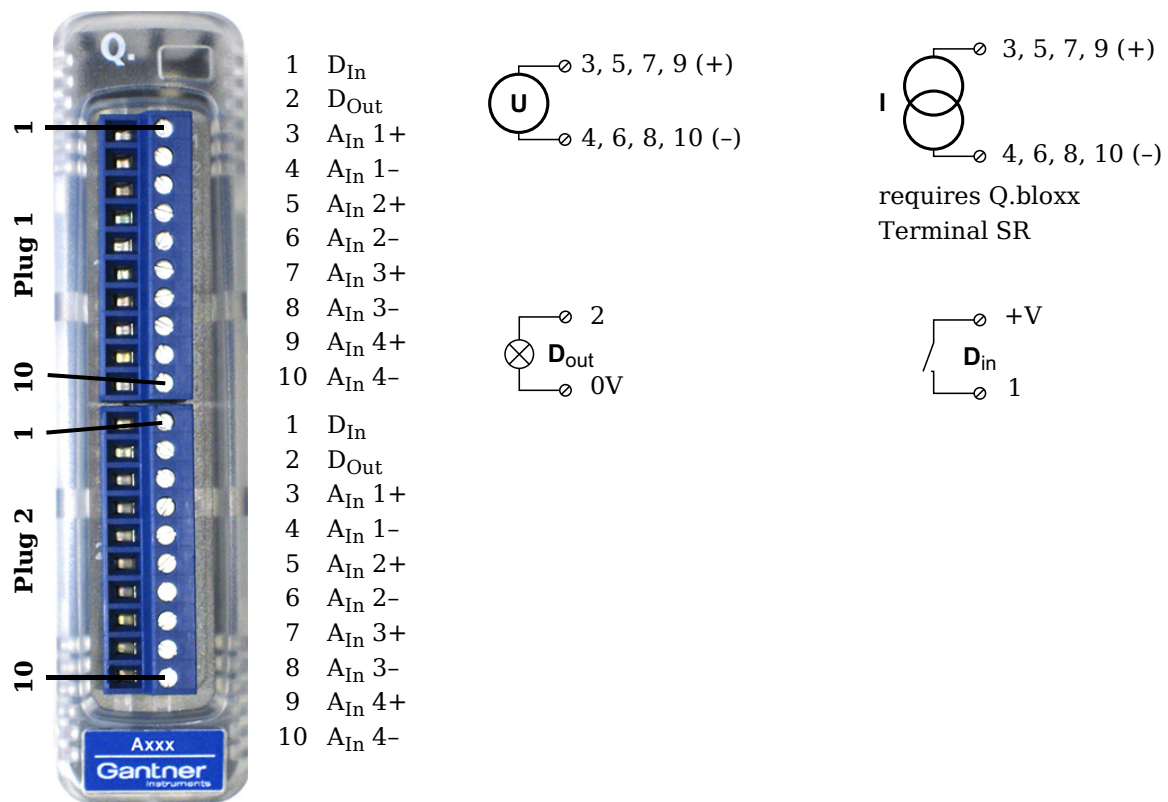

Fig. 4-36 Pin assignment for Q.bloxx Module A103.

i Tip

Further information on transducers and sensors can also be found in Chapter 6 ff. page 135.

4.10.1

Voltage

You can measure voltages of up to ±10V.

! **IMPORTANT**

Voltages which exceed the admissible limits produce incorrect measurement data, because the inputs are protected against overvoltages and limit the input voltage.

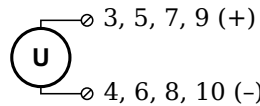

Fig. 4-37 A103, measurement of voltage.

4.10.2

Current

For current measurement you need the connecting plug Q.bloxx Terminal SR containing the shunt resistances. This facilitates the measurement of currents of up to 25 mA.

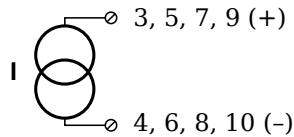

Fig. 4-38 A103, measurement of current via Q.bloxx Terminal SR.

4.10.3

Digital input and output

On each connecting plug two contacts are available for an input and an output.



Fig. 4-39 A103, Digital Input and Output.

The digital input is active (high level) when the applied signal voltage lies above the threshold of 10V.

4.11

Q.bloxx A104: Connecting sensors

The Q.bloxx Module A104 has eight electrically isolated analog inputs for thermocouples or voltages. The pin assignment of the two connector strips is identical and the connection terminals have numbers for identifying the connections. You will find the associated figures in each case at the same place in the circuit diagrams, for example each of the figures quoted in the second place belong to one possible connection method.

Measurement ground (-) and the (module) supply voltage are electrically isolated in the module.

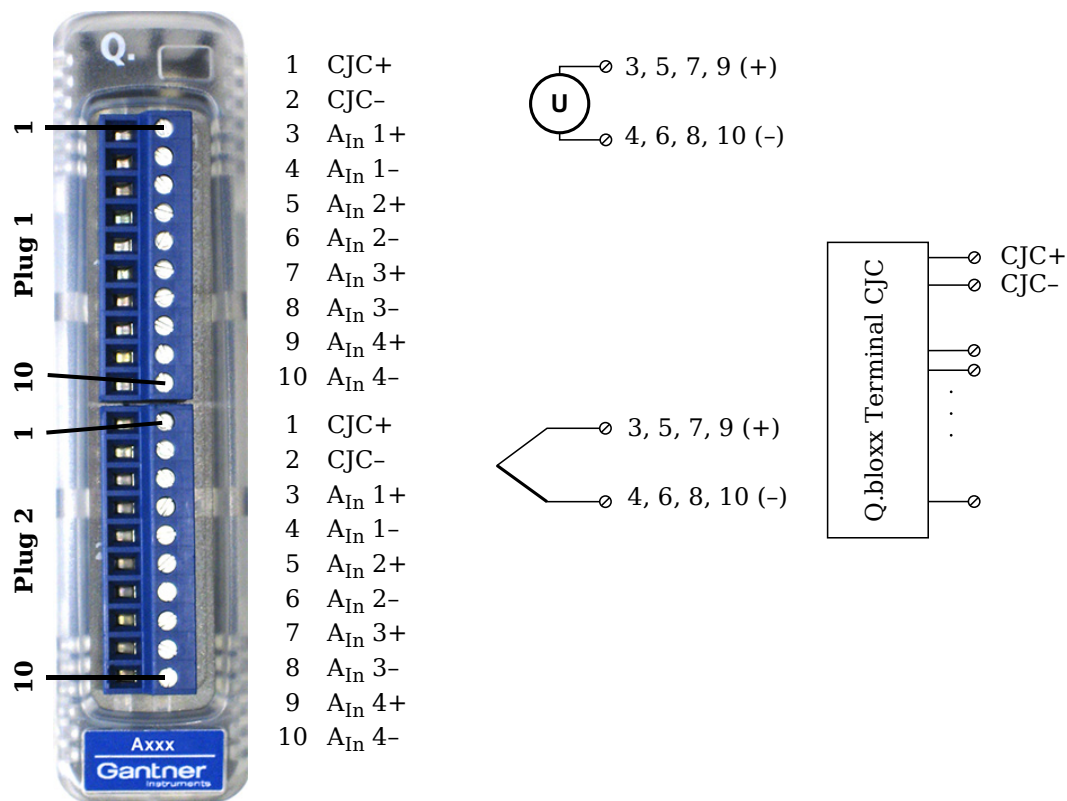

Fig. 4-40 Pin assignment for Q.bloxx Module A104.

i Tip

Further information on transducers and sensors can also be found in Chapter 6 ff. page 135.

4.11.1

Voltage

You can measure voltages of up to 80mV.

! **IMPORTANT**

Voltages which exceed the admissible limits produce incorrect measurement data, because the inputs are protected against overvoltages and limit the input voltage.

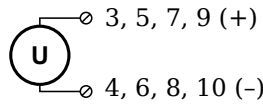

Fig. 4-41 A104, voltage measurement.

4.11.2

Thermocouple

For connecting thermocouples you need a special connecting plug which contains the comparative measuring point (cold junction compensation) required for thermocouples. The plug can be obtained under the designation Q.bloxx Terminal CJC-A104 from Gantner Instruments GmbH. You can connect the following types of thermocouple: B, E, J, K, L, N, R, S, T and U.

Alternatively, you can also use two thermocouples or a reference temperature source.

i **Tip**

You will find information on the comparative measuring point and on the measurement with a reference temperature source in Section 6.6, *Measuring with thermocouples*, page 148.

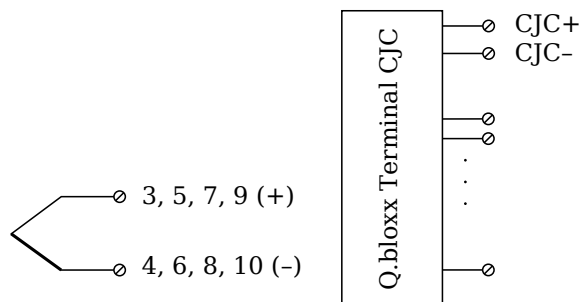

Fig. 4-42 A104, measurement with thermocouple using Q.bloxx Terminal CJC-A104.

4.12

Q.bloxx A105: Connecting sensors

The Q.bloxx Module A 105 has four electrically isolated analog inputs. The pin assignment of the two connector strips is identical and the connection terminals have numbers for identifying the connections. You will find the associated figures in each case at the same place in the circuit diagrams, for example each of the figures quoted in the second place belong to one possible connection method.

GND identifies the measurement ground of an input; measurement ground and the (module) supply voltage are electrically isolated in the module.

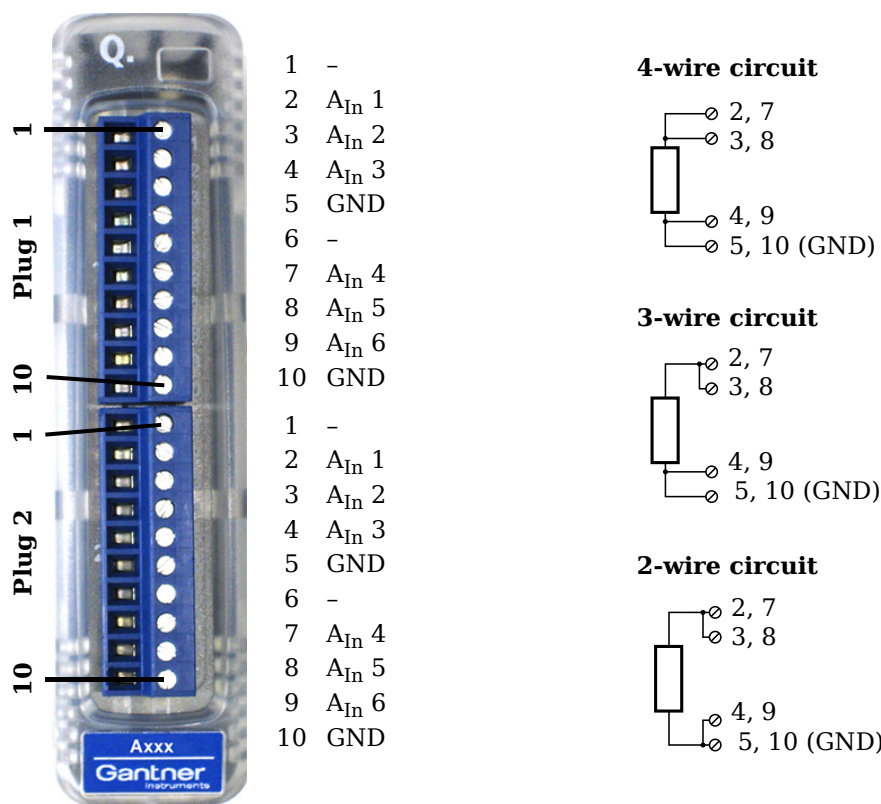

Fig. 4-43 Pin assignment for Q.bloxx Module A105.

i Tip

Further information on transducers and sensors can also be found in Chapter 6 ff. page 135.

4.12.1

Resistance, Pt100, Pt1000

You can connect resistances and Pt100/1000 probes in two-wire, three-wire or four-wire circuits. However, you must in each case connect *all* the terminals, i.e. you specify the circuit used for the type of circuit when configuring the module (**Type** column), but

with two and three-wire circuits the unused terminals must be bridged.

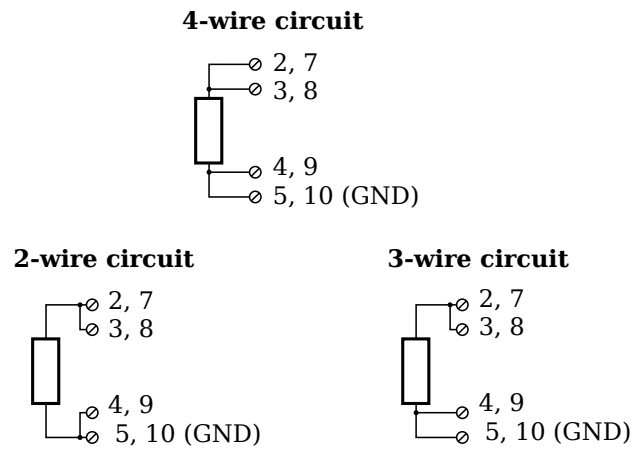

Fig. 4-44 A105, measurement of resistance and Pt100/1000 probes.

i Tip

Information about the types of circuit and the respective advantages and disadvantages can be found in Section 6.3, *Connecting sensors with sensing leads*, page 143.

4.13

Q.bloxx A106: Connecting sensors and I/O

The Q.bloxx Module A106 has two electrically isolated analog inputs, two analog outputs and four digital inputs and outputs. The pin assignment of the two connector strips is identical and the connection terminals have numbers for identifying the connections.

GND identifies the analog and the measurement ground, 0 V and +V refer to the (external) supply voltage connections. Measurement ground/GND and (module) supply voltage are electrically isolated in the module. The measurement ground for input and the analog ground (output) are identical.

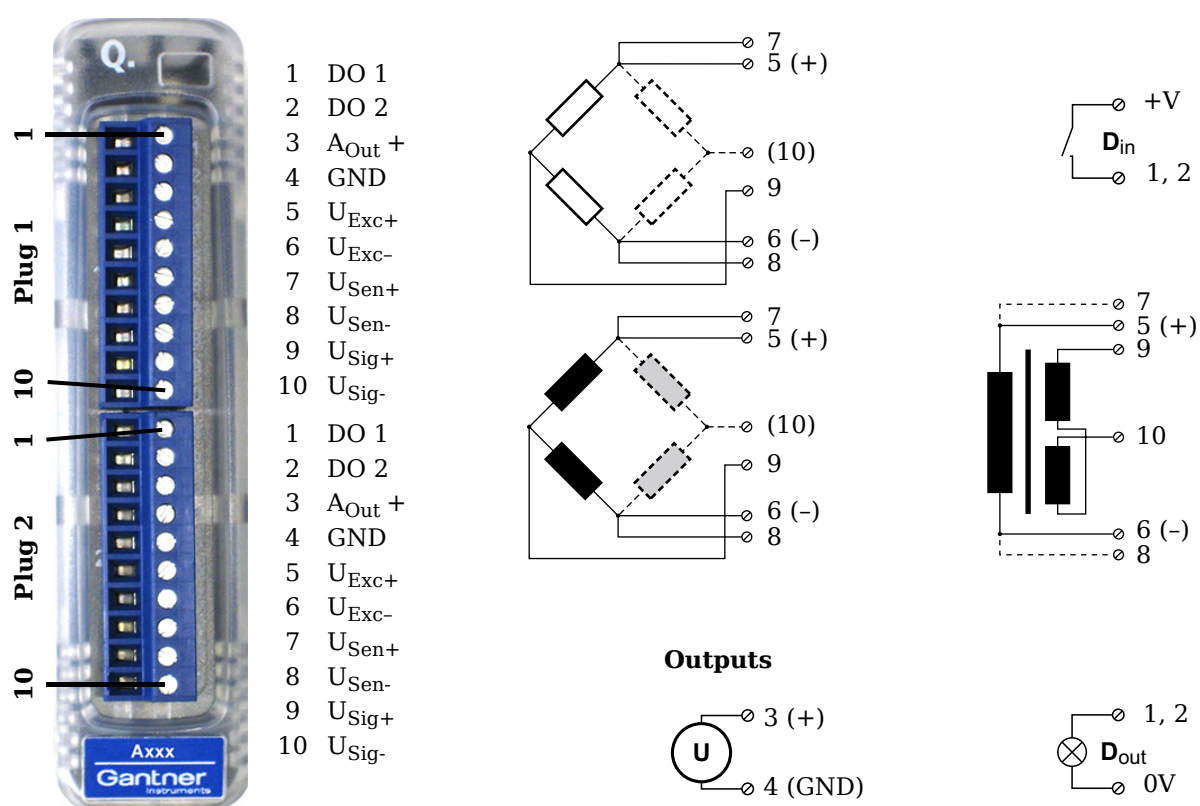

Fig. 4-45 Pin assignment for Q.bloxx Module A106.

i Tip

Further information on transducers and sensors can also be found in Chapter 6 ff. page 135.

4.13.1

Full and half-bridge transducers

With (resistive) full bridges (strain-gauge full bridges) all connections are occupied. If the sensor has no sensing leads, you specify this during the module configuration (**Type** column). With half

bridges the side drawn in broken lines and the connection 10 are omitted.

The bridge excitation voltage can be 2.5V or 5V (DC or CF).

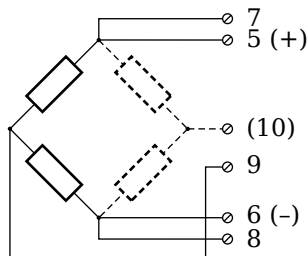

Fig. 4-46 A106, measurement with full and half bridges.

i Tip

Information about the types of circuit and the respective advantages and disadvantages can be found in Section 6.3, *Connecting sensors with sensing leads*, page 143.

4.13.2

Strain-gauge quarter bridge

For the connection of strain-gauge quarter bridges you need a special connecting plug which contains the completion resistances. The plug can be obtained under the designation Q.bloxx Terminal B4/120-A106 with 120Ω or B4/350-A106 with 350Ω from Gantner Instruments GmbH.

The bridge excitation voltage can be 2.5V or 5V (DC or CF).

! IMPORTANT

The plug must have the same resistance values as the strain gauges used, because otherwise no measurement is possible. Select a half-bridge circuit as the type of bridge for the channel.

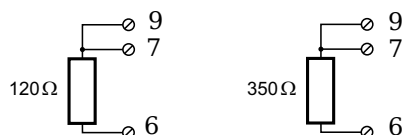

Fig. 4-47 A106, measurement with strain-gauge quarter bridge using Q.bloxx Terminal B4.

4.13.3

Inductive full and half bridges

With inductive full bridges all connections are occupied. If the sensor has no sensing leads, you specify this during the module configuration (**Type** column). With half bridges the side drawn in broken lines and the connection 10 are omitted.

The bridge excitation voltage can be 2.5V or 5V.

! IMPORTANT

During the configuration set **CF 4800Hz** (carrier frequency) in the **Type** column; inductive sensors cannot be operated with direct voltage (DC) or 600Hz carrier frequency.

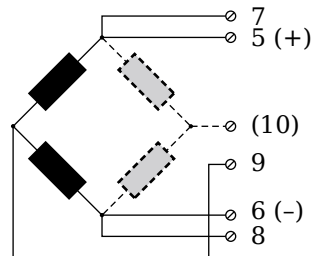

Fig. 4-48 A106, measurement with inductive full and half bridges.

4.13.4

LVDT, RVDT

With (inductive) LVDTs or RVDTs all connections can be occupied, but you can also connect without sense leads and state this in the **Type** column when configuring the module.

The bridge excitation voltage can be 2.5V or 5V.

! IMPORTANT

During the configuration set **CF 4800Hz** (carrier frequency) in the **Type** column; inductive sensors cannot be operated with direct voltage (DC) or 600Hz carrier frequency.

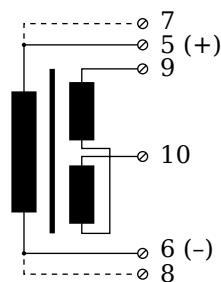

Fig. 4-49 A106, measurement with LVDTs and RVDTs.

4.13.5

Analog output

An analog voltage output is available on each connecting plug.

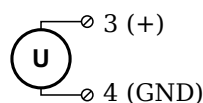

Fig. 4-50 A106, analog output.

4.13.6**Digital input and output**

On each connecting plug two contacts are available for an input or output. You can use the appropriate function depending on the wiring.



Fig. 4-51 A106, Digital Input and Output.

The digital input is active (high level) when the applied signal voltage lies above the threshold of 10V.

4.14

Q.bloxx A107: Connecting sensors

The Q.bloxx Module A 107 has four electrically isolated analog inputs. The pin assignment of the two connector strips is identical and the connection terminals have numbers for identifying the connections. You will find the associated figures in each case at the same place in the circuit diagrams, for example each of the figures quoted in the second place belong to one possible connection method.

GND identifies the measurement ground. The four inputs (UF to GND) are electrically isolated in the module one to the other and to the (module) supply voltage.

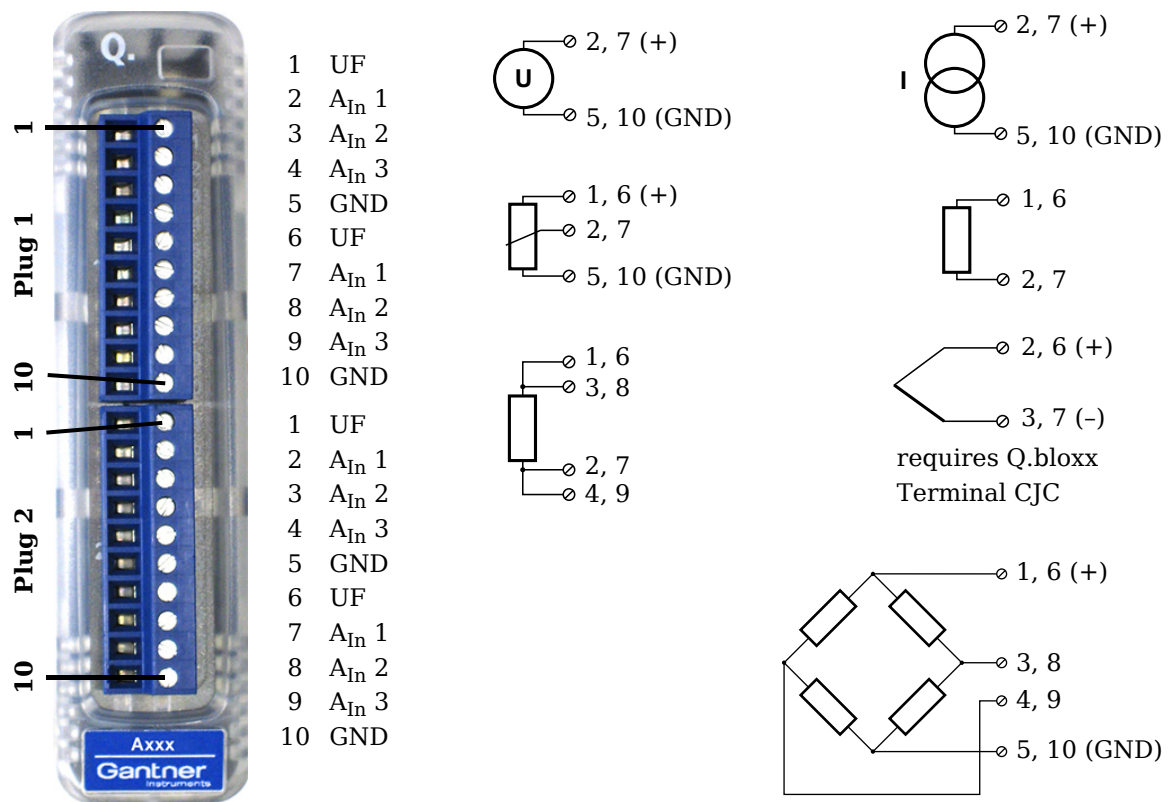

Fig. 4-52 Pin assignment for Q.bloxx Module A107.

i Tip

Further information on transducers and sensors can also be found in Chapter 6 ff. page 135.

4.14.1

Voltage

You can measure voltages of up to 10V.

! **IMPORTANT**

Voltages which exceed the admissible limits produce incorrect measurement data, because the inputs are protected against overvoltages and limit the input voltage.

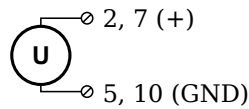

Fig. 4-53 A107, measurement of voltage.

4.14.2

Current

A shunt resistance of 50Ω is integrated into the Q.bloxx Module A107 for current measurement. This facilitates the measurement of currents of up to 25 mA. For higher currents use a voltage measurement and an external shunt; refer to Section 6.5, page 147.

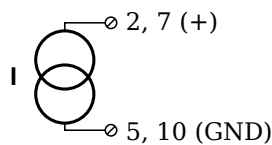

Fig. 4-54 A107, measurement of current.

4.14.3

Potentiometer

Potentiometers with resistances between $1\text{ k}\Omega$ and $10\text{ k}\Omega$ are connected in a three-wire configuration.

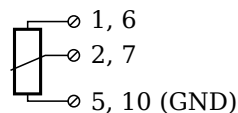

Fig. 4-55 A107, measurement with potentiometers.

4.14.4

Resistance, Pt100, Pt1000

You can connect resistances and Pt100/1000 probes in two-wire or four-wire circuits. You specify the selected type of circuit during the module configuration (**Type** column).

2-wire circuit

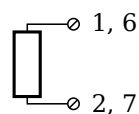

4-wire circuit

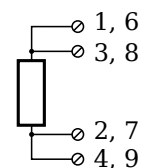

Fig. 4-56 A107, measurement of resistance and Pt100/1000 probes.

i Tip

Information about the types of circuit and the respective advantages and disadvantages can be found in Section 6.3, *Connecting sensors with sensing leads*, page 143.

4.14.5**Thermocouple**

For connecting thermocouples you need a special connecting plug which contains the comparative measuring point (cold point compensation) required for thermocouples. The plug can be obtained under the designation Q.bloxx Terminal CJC-A107 from Gantner Instruments GmbH. You can connect the following types of thermocouple: B, E, J, K, L, N, R, S, T and U.

Alternatively, you can also use two thermocouples or a reference temperature source.

i Tip

You will find information on the comparative measuring point and on the measurement with a reference temperature source in Section 6.6, *Measuring with thermocouples*, page 148.

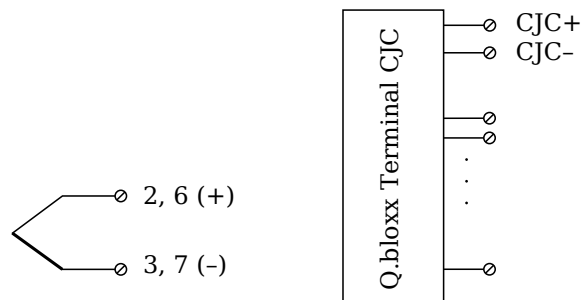

Fig. 4-57 A107, measurement with thermocouple using Q.bloxx Terminal CJC-A107.

4.14.6**Full-bridge transducer**

With (resistive) full bridges (strain-gauge full bridges) four connections are occupied. If the sensor has sense leads, you should connect them to the relevant supply lines (1 and 5 or 6 and 10).

The bridge excitation voltage is 2.5V.

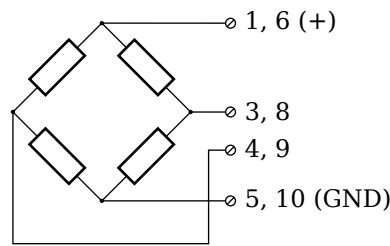

Fig. 4-58 A107, measurement with full bridges.

4.14.7

Strain-gauge half and quarter bridges

For the connection of strain-gauge half or quarter bridges you need a special connecting plug which contains the completion resistances. The plug can be obtained under the designation Q.bloxx Terminal B4/120-A107 with 120Ω or B4/350-A107 with 350Ω from Gantner Instruments GmbH.

The bridge excitation voltage is 2.5V.

! IMPORTANT

For strain-gauge quarter bridges the plug must have the same resistance values as the strain gauges used, because otherwise no measurement is possible.

Since, for reasons of stability, all necessary completion resistances are located in the Q.bloxx Terminal, you have to select a full bridge circuit as the bridge type for the channel.

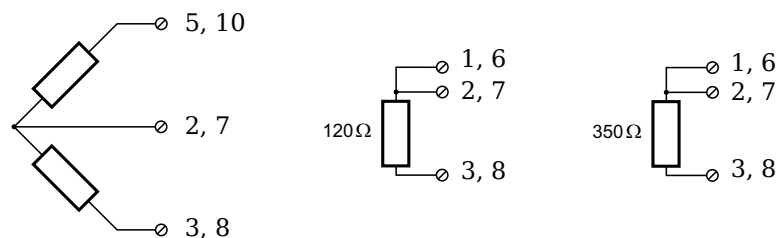

Fig. 4-59 A107, measurement with strain-gauge half bridge and quarter bridge using Q.bloxx Terminal B4.

4.15

Q.bloxx A108: Connecting sensors and I/O

The Q.bloxx Module A108 has eight electrically isolated analog inputs and two digital inputs and outputs. The pin assignment of the two connector strips is identical and the connection terminals have numbers for identifying the connections. You will find the associated figures in each case at the same place in the circuit diagrams, for example each of the figures quoted in the second place belong to one possible connection method.

The designations 0 V and +V refer to the (external) supply voltage connections. Measurement ground (-) and the (module) supply voltage are electrically isolated in the module.

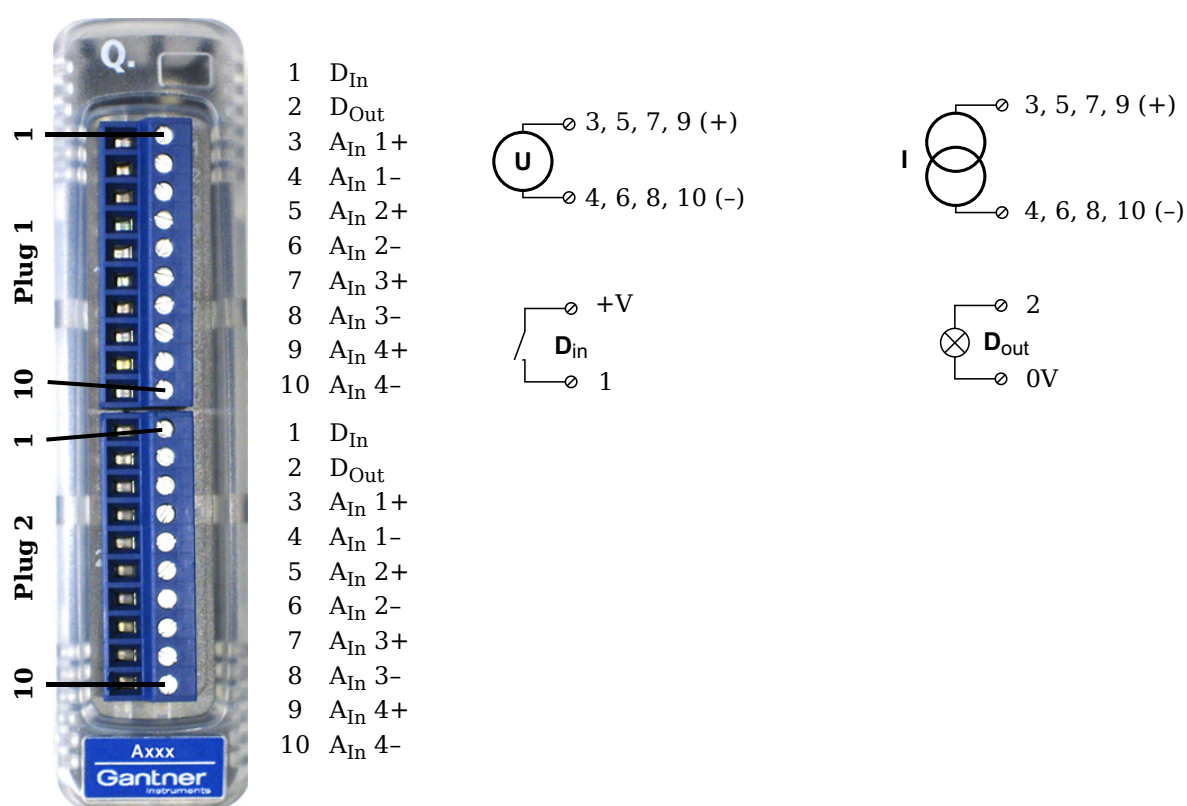

Fig. 4-60 Pin assignment for Q.bloxx Module A108.

i Tip

Further information on transducers and sensors can also be found in Chapter 6 ff. page 135.

4.15.1

Voltage

You can measure voltages of up to 10V.

! **IMPORTANT**

Voltages which exceed the admissible limits produce incorrect measurement data, because the inputs are protected against overvoltages and limit the input voltage.

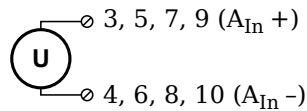

Fig. 4-61 A108, voltage measurement.

4.15.2

Current

For current measurement you need the Q.bloxx Terminal SR connecting plug containing the shunt resistances. This facilitates the measurement of currents of up to 25 mA.

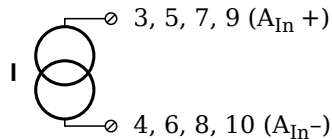

Fig. 4-62 A108, current measurement using the Q.bloxx Terminal SR.

4.15.3

Digital input and output

On each connecting plug of the terminal version two contacts are available in each case for one input and one output.



Fig. 4-63 A108, digital input and output.

The digital input is active (high level) when the applied signal voltage lies above the threshold of 10V.

4.16

Q.bloxx A109: Connecting I/O and outputs

The Q.bloxx Module A109 has four electrically isolated analog outputs, four digital inputs and four digital outputs. The assignment of both connector strips is *not* identical. The plug number is specified in the following. The connection terminals have numbers for identifying the connections. You will find the associated figures in each case at the same place in the circuit diagrams, for example each of the figures quoted in the second place belong to one possible connection method.

The designations 0 V and +V refer to the (external) supply voltage connections, NC indicates “not assigned”. Analog ground (-) and the (external) supply voltage (0 V) are electrically isolated in the module.

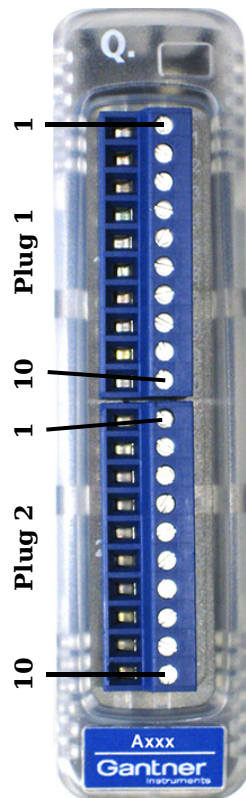

- 1 +V
 - 2 D_{Out} 1
 - 3 D_{Out} 2
 - 4 D_{Out} 3
 - 5 D_{Out} 4
 - 6 D_{In} 1
 - 7 D_{In} 2
 - 8 D_{In} 3
 - 9 D_{In} 4
 - 10 0V
-
- 1 NC
 - 2 NC
 - 3 A_{Out} 1+
 - 4 A_{Out} 1-
 - 5 A_{Out} 2+
 - 6 A_{Out} 2-
 - 7 A_{Out} 3+
 - 8 A_{Out} 3-
 - 9 A_{Out} 4+
 - 10 A_{Out} 4-

Plug 1, digital inputs and outputs

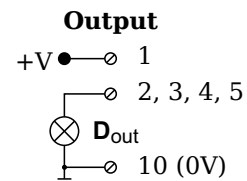
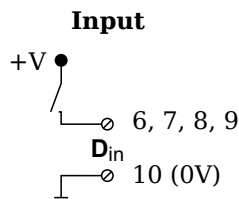

+V must be between 12 V and 30 V

Plug 2, analog outputs

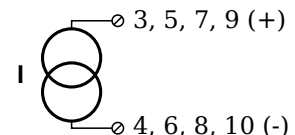
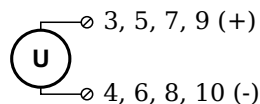

Fig. 4-64 Pin assignment for Q.bloxx Module A109.

4.16.1

Digital input and output, Plug 1

On Plug 1 contacts for four inputs and four outputs are available. Since the inputs and outputs of this module are electrically isolated from the supply voltage, you must also connect 0V for the inputs and 0V and a supply voltage (+V) for the outputs.

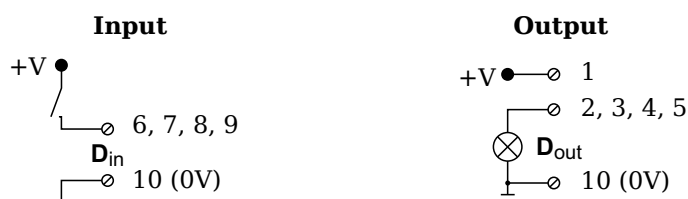

Fig. 4-65 A109, digital input and output, Plug 1.

The digital input is active (high level) when the applied signal voltage lies above the (programmable) threshold.

Possible combinations of contact assignments for the inputs are shown in the following table; refer also to the block diagrams for Module D101.

6	7	8	9
status	status	status	status
status	status	2-channel signal ¹⁾	
2-channel signal ¹⁾		2-channel signal ¹⁾	
4-channel signal ²⁾			

1) e.g. counter with additional input for counting direction or 2-phase counter signals or frequency measurement with direction detection (torque transducers)

2) e.g. counter with additional inputs for counting direction, zero reference and reset/enable for zero reference

4.16.2

Analog output, Plug 2

The analog outputs on Plug 2 supply voltage or current. Selection is made via software.



Fig. 4-66 A109, output of voltage or current, Plug 2.

4.17

Q.bloxx A111: Connecting sensors and I/O

The Q.bloxx Module A 111 has four electrically isolated analog inputs. The pin assignment of the two connector strips is identical and the connection terminals have numbers for identifying the connections. You will find the associated figures in each case at the same place in the circuit diagrams, for example each of the figures quoted in the second place belong to one possible connection method. NC signifies “No Connection”.

Measurement ground and (module) supply voltage are electrically isolated in the module.

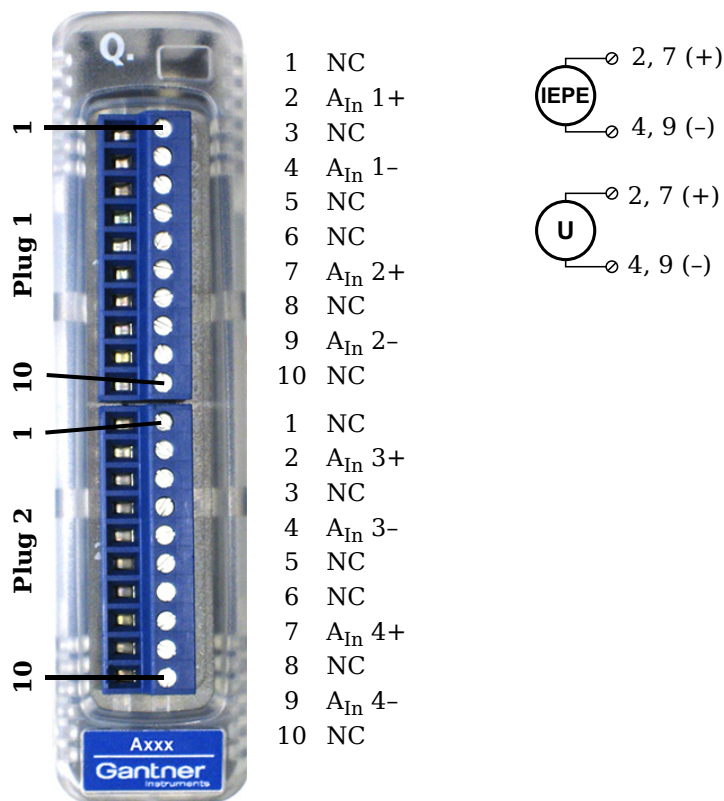

Fig. 4-67 Pin assignment for Q.bloxx Module A111.

i Tip

Further information on transducers and sensors can also be found in Chapter 6 ff. page 135.

4.17.1

Voltage

You can measure voltages of up to 10V.

! IMPORTANT

Voltages which exceed the admissible limits produce incorrect measurement data, because the inputs are protected against overvoltages and limit the input voltage.

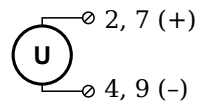

Fig. 4-68 A111, measurement of voltage.

4.17.2**IEPE/ICP[®] Sensor**

The sensor is supplied with 4 mA of current from the module (current supply).

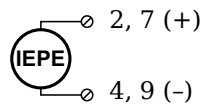

Fig. 4-69 A111, measurement with IEPE or ICP[®] sensors.

4.18

Q.bloxx A116: Connecting sensors

The Q.bloxx Module A116 has eight analog inputs. We recommend that either the Q.bloxx Connection Terminal A116 (Fig. 4-71) or the Cable A116 (Fig. 4-72) is used with free ends for connection. You will find the associated connectors in each case at the same place in the circuit diagrams, for example each of the figures quoted in the second place belongs to one possible connection method.

The channels (measurement ground) are electrically isolated against the (module) supply voltage and the interface.

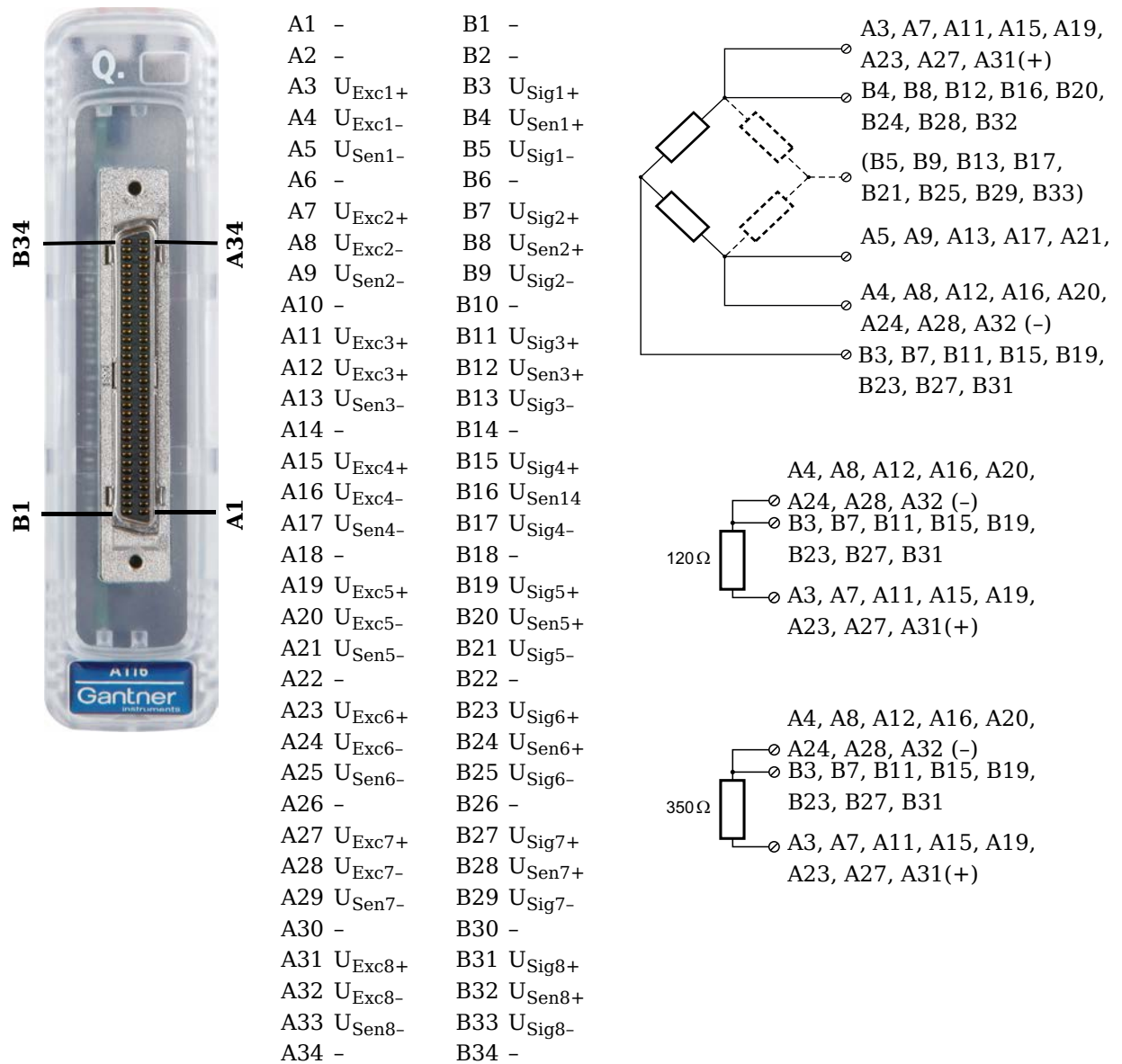

Fig. 4-70 Pin assignment for Q.bloxx Module A116.

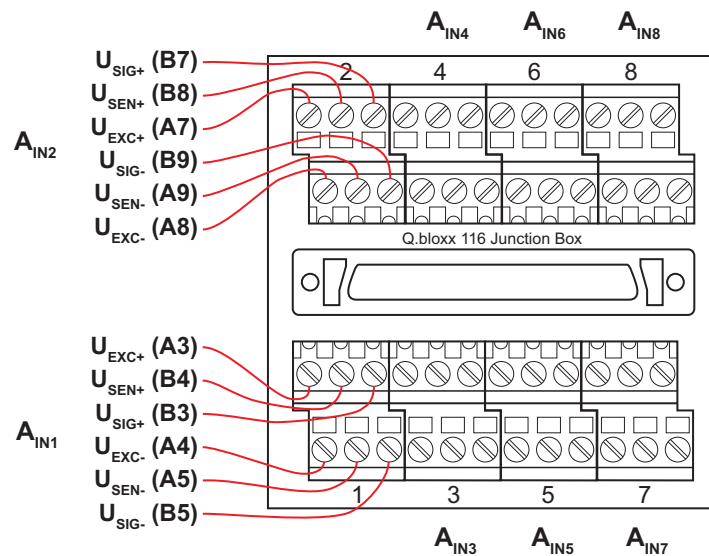

Fig. 4-71 Terminal assignment for the Q.bloxx Connection Terminal CT A116.

Assignment of the cable cores for a cable termination with free ends Cable A116:

Input/ cable bundle	Pairing	Cable color	Sensor connec- tion	Socket connection
1	Pair 1	Light brown	U_{Exc+}	A3
		Light brown/red	U_{Exc-}	A4
	Pair 2	Light green	U_{Sen+}	B4
		Light green/black	U_{Sen-}	A5
	Pair 3	White	U_{Sig+}	B3
		White/black	U_{Sig-}	B5
2	Pair 1	Red/white	U_{Exc+}	A7
		Red/blue	U_{Exc-}	A8
	Pair 2	Yellow/red	U_{Sen+}	B8
		Yellow/blue	U_{Sen-}	A9
	Pair 3	Grey/red	U_{Sig+}	B7
		Grey/blue	U_{Sig-}	B9

Input/ cable bundle	Pairing	Cable color	Sensor connec- tion	Socket connection
3	Pair 1	Blue	U_{Exc+}	A11
		Blue/white	U_{Exc-}	A12
	Pair 2	Pink/red	U_{Sen+}	B12
		Pink/blue	U_{Sen-}	A13
	Pair 3	Light green/yellow	U_{Sig+}	B11
		Light green/green	U_{Sig-}	B13
4	Pair 1	Green/white	U_{Exc+}	A15
		Light green/white	U_{Exc-}	A16
	Pair 2	Light blue/blue	U_{Sen+}	B16
		Light blue/red	U_{Sen-}	A17
	Pair 3	Black	U_{Sig+}	B15
		Black/white	U_{Sig-}	B17
5	Pair 1	Pink	U_{Exc+}	A19
		Pink/black	U_{Exc-}	A20
	Pair 2	Orange/white	U_{Sen+}	B20
		Grey/white	U_{Sen-}	A21
	Pair 3	White/red	U_{Sig+}	B19
		White/blue	U_{Sig-}	B21
6	Pair 1	Light green/red	U_{Exc+}	A23
		Green/blue	U_{Exc-}	A24
	Pair 2	Red	U_{Sen+}	B24
		Red/black	U_{Sen-}	A25
	Pair 3	Purple	U_{Sig+}	B23
		Purple/white	U_{Sig-}	B25

Input/ cable bundle	Pairing	Cable color	Sensor connec- tion	Socket connection
7	Pair 1	Green	U_{Exc+}	A27
		Green/black	U_{Exc-}	A28
	Pair 2	Light blue/green	U_{Sen+}	B28
		Light blue/yellow	U_{Sen-}	A29
	Pair 3	Light yellow	U_{Sig+}	B27
		Light yellow/red	U_{Sig-}	B29
8	Pair 1	Grey	U_{Exc+}	A31
		Grey/black	U_{Exc-}	A32
	Pair 2	White/yellow	U_{Sen+}	B32
		White/green	U_{Sen-}	A33
	Pair 3	Brown	U_{Sig+}	B31
		Brown/white	U_{Sig-}	B33

Fig. 4-72 Assignment of the cores for a cable termination with free ends Cable A116.

i Tip

Further information on transducers and sensors can also be found in Chapter 6 ff. page 135.

4.18.1

Full and half-bridge transducers

With (resistive) full bridges (strain-gauge full bridges) six connections are used per measuring point. If the sensor has no sensing leads, you specify this during the module configuration (**Type** column); the U_{Sen} inputs then remain open. With half bridges the side drawn in dashes and the U_{Sig-} connection are omitted.

The bridge excitation voltage is $2V_{DC}$; with 350Ω sensor resistance you can also use $4V_{DC}$. The internal shunt resistance can be activated also with full and half bridges.

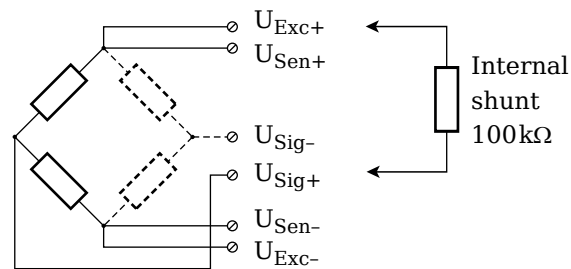

Input 1		Input 2		Input 3		Input 4	
U_{Exc+}	A3	U_{Exc+}	A7	U_{Exc+}	A11	U_{Exc+}	A15
U_{Exc-}	A4	U_{Exc-}	A8	U_{Exc-}	A12	U_{Exc-}	A16
U_{Sen+}	B4	U_{Sen+}	B8	U_{Sen+}	B12	U_{Sen+}	B16
U_{Sen-}	A5	U_{Sen-}	A9	U_{Sen-}	A13	U_{Sen-}	A17
U_{Sig+}	B3	U_{Sig+}	B8	U_{Sig+}	B11	U_{Sig+}	B15
U_{Sig-}	B5	U_{Sig-}	B9	U_{Sig-}	B13	U_{Sig-}	B17

Input 5		Input 6		Input 7		Input 8	
U_{Exc+}	A19	U_{Exc+}	A23	U_{Exc+}	A27	U_{Exc+}	A31
U_{Exc-}	A20	U_{Exc-}	A24	U_{Exc-}	A28	U_{Exc-}	A32
U_{Sen+}	B20	U_{Sen+}	B24	U_{Sen+}	B28	U_{Sen+}	B32
U_{Sen-}	A21	U_{Sen-}	A25	U_{Sen-}	A29	U_{Sen-}	A33
U_{Sig+}	B19	U_{Sig+}	B23	U_{Sig+}	B27	U_{Sig+}	B31
U_{Sig-}	B21	U_{Sig-}	B25	U_{Sig-}	B29	U_{Sig-}	B33

Fig. 4-73 A116, measurement with full and half bridges, direct connection; U_{SIG} = signal voltage (output signal), U_{SEN} = sense lead, U_{EXC} = excitation voltage

You will find the terminal assignment for the terminal CT A116 or the Cable A116 in the first section of this chapter. For the activation of the shunt resistance refer to Section 4.18.3.

i Tip

Information about the types of circuit and the respective advantages and disadvantages can be found in Section 6.3, *Connecting sensors with sensing leads*, page 143.

4.18.2

Strain-gauge quarter bridge

With this module, for the connection of strain-gauge quarter bridges you do not need any special connection plugs as the 120Ω and 350Ω completion resistances are present in the module and only need to be activated. In addition you can activate the internal shunt resistance for test purposes.

The bridge excitation voltage is $2V_{DC}$; with 350Ω sensor resistance you can also use $4V_{DC}$.

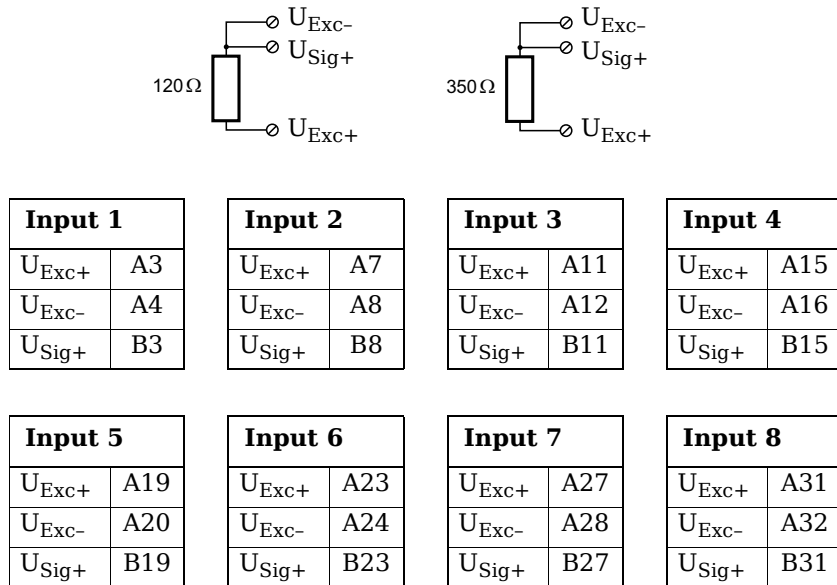

Fig. 4-74 A116, measurement with a strain-gauge quarter bridge, direct connection.

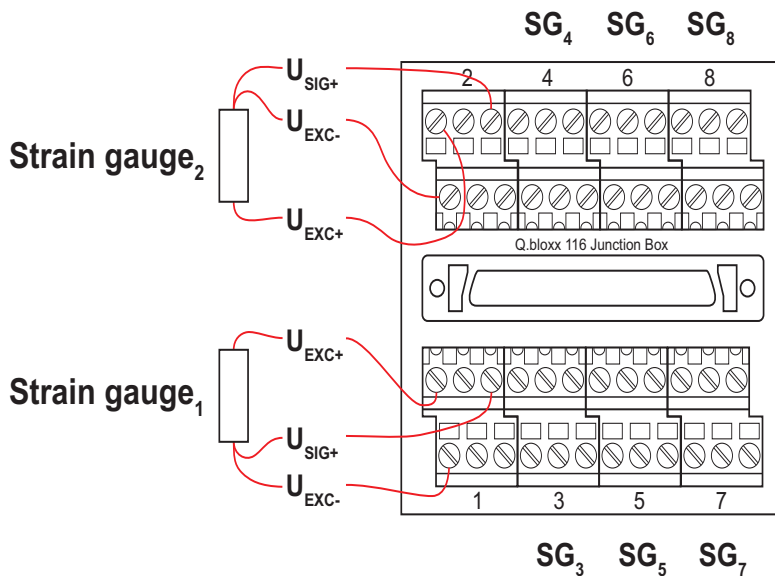

Fig. 4-75 A116, measurement with a strain-gauge quarter bridge. Connection assignment for the Q.bloxx Connection Terminal CT A116.

You will find the terminal assignment for the Cable A116 in the first section of this chapter. With quarter bridges only U_{Exc+} , U_{Exc-} and U_{Sig+} are assigned. For the activation of the shunt resistance refer to Section 4.18.3.

With the three-wire circuit the internal completion resistance is used in this module to determine the voltage drop over the cable and to correct the result accordingly. In this way not only can the influence of the temperature on the cable (normal three-wire circuit) be compensated, but also the loss of sensitivity due to the cable resistance over a wide range.

4.18.3

Activating the shunt resistance

You can activate the shunt both via a variable and manually via a button.

Open the module settings dialog (Fig. 4-76), activate the tab **Variable definition** and click in the column **Format/balance**. The dialog of Fig. 4-77 opens.

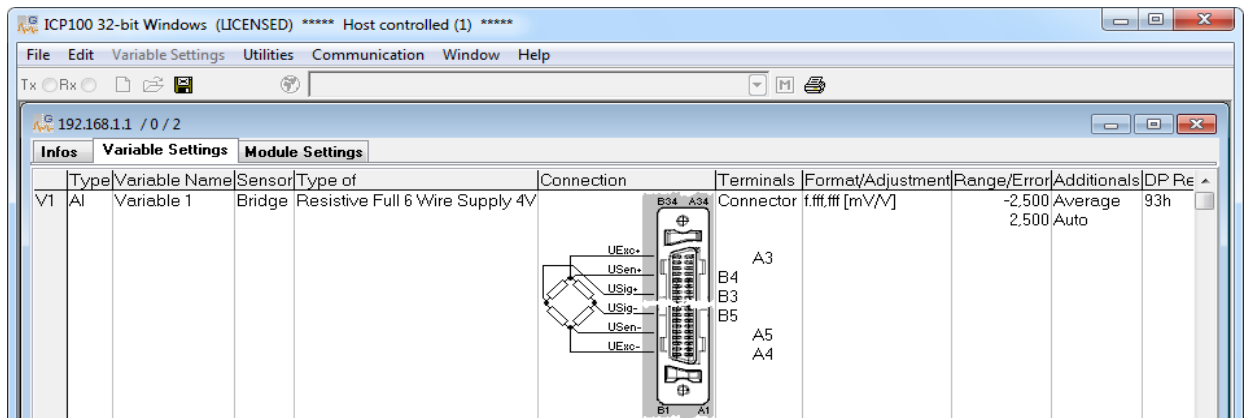

Fig. 4-76 Module configuration dialog.

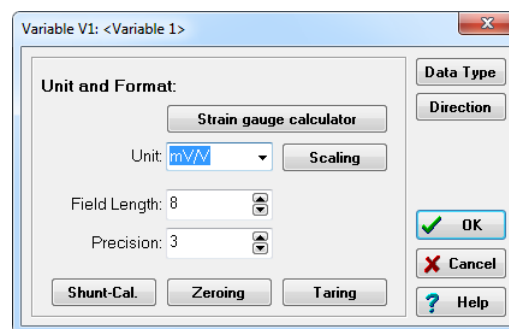

Fig. 4-77 Dialog for format settings.

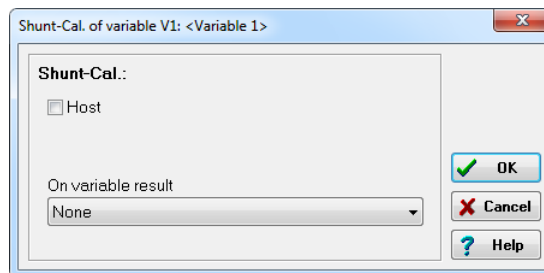

Fig. 4-78 Dialog for shunt activation.

Manual activation

Define the **Direction** for the variable on **Input/output** (Fig. 4-77) and click on **Shunt cal.** Activate **Control computer** in the dialog (Fig. 4-78).

Setting a value of **16** for the variable (the channel) activates the shunt and **0** deactivates it again.

Activation via variable

Click on **Shunt cal.** Activate **At variable value** in the dialog (Fig. 4-78) and specify the variable to be used.

Any variable value > 0.5 activates the shunt.

4.19

Q.bloxx A123: Connecting sensors

⚠ DANGER

The cables to be connected or disconnected may carry voltages of up to 1200 V!

Before connecting or disconnecting cables make sure that all sources of power are Locked Out.

The Q.bloxx module A123 can be used in the categories CAT II up to 1000V and CAT III up to 600V and has four electrically isolated analog inputs. The pin assignment of the two connector strips is identical and the connection terminals have numbers for identifying the connections. You will find the associated figures in each case at the same place in the circuit diagrams, for example each of the figures quoted in the second place belong to one possible connection method.

Measurement ground (-) and the (module) supply voltage are electrically isolated in the module. NC signifies "No Connection". The plugs for the A123 module are 5-way plugs with push-in spring technology, i.e. you can insert a solid wire or a fine-stranded wire with a wire-end sleeve directly without screwing (max. 1.5 mm²). With a screwdriver press on the white opener to remove the connection.

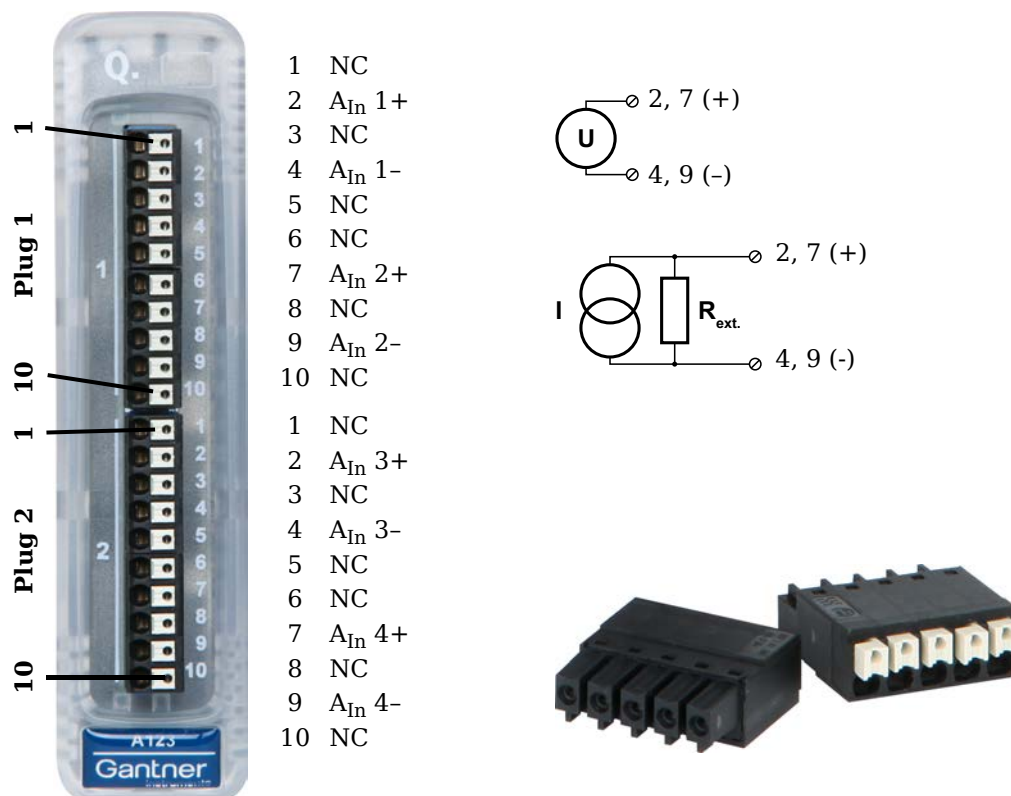

Fig. 4-79 Pin assignment and plugs for the Q.bloxx module A123.

i Tip

Further information on transducers and sensors can also be found in Chapter 6 ff. page 135.

4.19.1

Voltage

You can measure voltage differences of up to $\pm 10\text{V}$. The voltage level (the potential) may be up to 1200V_{DC} .

! IMPORTANT

Voltage differences which exceed the admissible limits produce incorrect measurement data, because the inputs are protected against overvoltages and limit the input voltage.

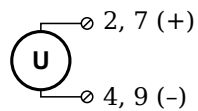

Fig. 4-80 A123, voltage measurement.

4.19.2

Current

You need an (external) shunt resistance for the current measurement, refer also to Section 6.5, page 147.

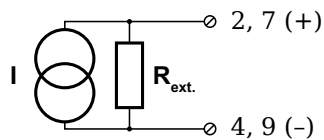

Fig. 4-81 A123, current measurement using an external shunt resistance.

4.20

Q.bloxx A124: Connecting sensors

⚠ DANGER

The cables to be connected or disconnected may carry voltages of up to 1200 V!

Before connecting or disconnecting cables make sure that all sources of power are Locked Out.

The Q.bloxx module A124 can be used in the categories CAT II up to 1000V and CAT III up to 600V and has four electrically isolated analog inputs for thermocouples. The terminal assignment is identical. You will find the associated figures in each case at the same place in the circuit diagrams, for example each of the figures quoted in the second place belong to one possible connection method.

Measurement ground (-) and the (module) supply voltage are electrically isolated in the module. The plugs for the A124 module are 2-way plugs with push-in spring technology, i.e. you can insert a solid wire or a fine-stranded wire with a wire-end sleeve directly without screwing (max. 1.5 mm²). The plugs are permanently joined to the housing and cannot be removed. With a screwdriver press on the white opener to remove the connection.

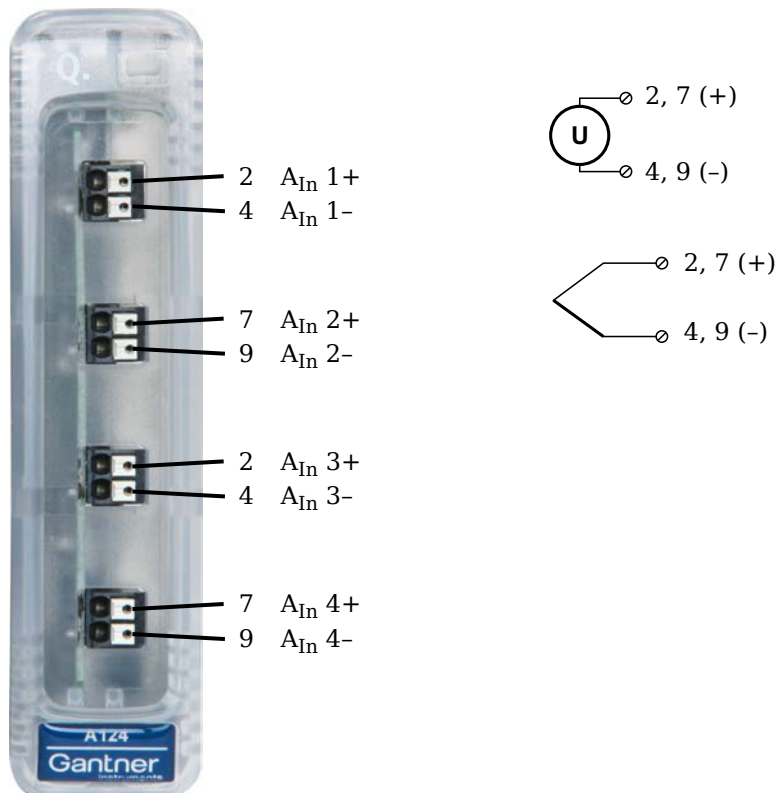

Fig. 4-82 Pin assignment for Q.bloxx Module A104.

i Tip

Further information on transducers and sensors can also be found in Chapter 6 ff. page 135.

4.20.1

Voltage

You can measure voltage differences of up to $\pm 80\text{mV}$. The voltage level (the potential) may be up to 1200V_{DC} .

! IMPORTANT

Voltage differences which exceed the admissible limits produce incorrect measurement data, because the inputs are protected against overvoltages and limit the input voltage.

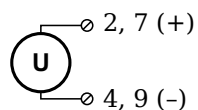

Fig. 4-83 A124, voltage measurement.

4.20.2

Thermocouple

Thermocouples can be connected directly; the comparative measuring point (cold junction compensation) is integrated in the module plug. You can connect the following types of thermocouple: B, E, J, K, L, N, R, S, T and U.

Alternatively, you can also use two thermocouples or a reference temperature source.

i Tip

You will find information on the comparative measuring point and on the measurement with a reference temperature source in Section 6.6, *Measuring with thermocouples*, page 148.

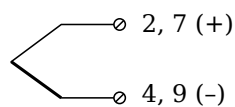

Fig. 4-84 A124, measurement with a thermocouple.

4.21

Q.bloxx A127: Connecting sensors

⚠ DANGER



The cables to be connected or disconnected may carry voltages of up to 1200 V!

Before connecting or disconnecting cables make sure that all sources of power are Locked Out.

The Q.bloxx module A127 can be used in the categories CAT II up to 1000V and CAT III up to 600V and has four electrically isolated analog inputs. The pin assignment of the two connector strips is identical and the connection terminals have numbers for identifying the connections. You will find the associated figures in each case at the same place in the circuit diagrams, for example each of the figures quoted in the second place belong to one possible connection method.

Measurement ground (-) and the (module) supply voltage are electrically isolated in the module. NC signifies “No Connection”. The plugs for the A127 module are 5-way plugs with push-in spring technology, i.e. you can insert a solid wire or a fine-stranded wire with a wire-end sleeve directly without screwing (max. 1.5 mm²). With a screwdriver press on the white opener to remove the connection.

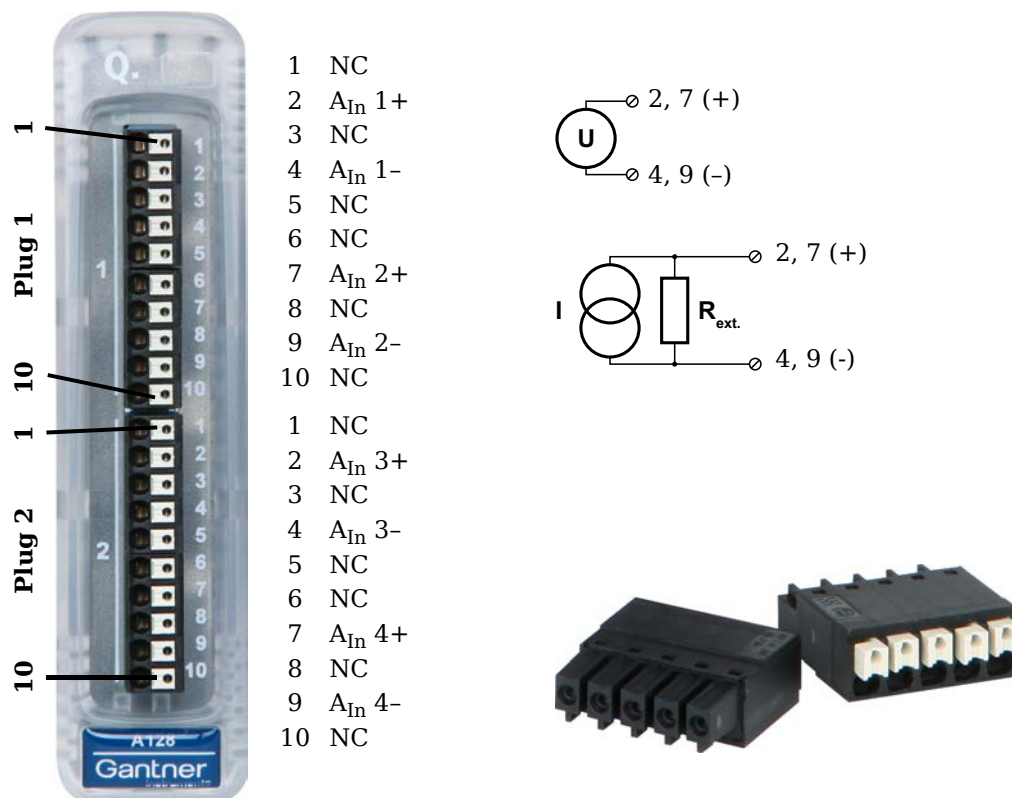

Fig. 4-85 Pin assignment and plugs for the Q.bloxx module A127.

i Tip

Further information on transducers and sensors can also be found in Chapter 6 ff. page 135.

4.21.1

Voltage

You can measure voltage differences of up to $\pm 1200\text{V}$. Here, various input voltage ranges from $\pm 40\text{V}_{\text{DC}}$ to $\pm 1200\text{V}_{\text{DC}}$ are possible. The voltage level (the potential) may be up to 1200V_{DC} .

NOTICE

Voltages above 1200V can damage the module.

Each module is tested with a test voltage of 5kV_{DC} for one minute. A longer duration or a higher voltage can damage the module. In addition, each period of overvoltage reduces the service life of the module.

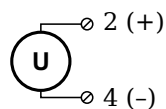

Fig. 4-86 A127, measurement of voltage.

! IMPORTANT

Voltages which exceed the admissible limits give incorrect measurement data, because the input voltage is internally limited.

4.21.2

Current
NOTICE

Confusing the current and voltage inputs can damage the module and/or the external load resistance.

Make sure that no high voltages are applied to the current inputs. The voltage drop must not be beyond $\pm 2.4\text{V}$.

You need an (external) shunt resistance for the current measurement, refer also to Section 6.5, page 147.

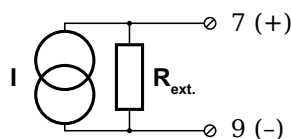

Fig. 4-87 A127, current measurement using an external shunt resistance.

4.22

Q.bloxx A128: Connecting sensors

DANGER



The cables to be connected or disconnected may carry voltages of up to 1200 V!

Before connecting or disconnecting cables make sure that all sources of power are Locked Out.

The Q.bloxx module A128 can be used in the categories CAT II up to 1000V and CAT III up to 600V and has four electrically isolated analog inputs. The pin assignment of the two connector strips is identical and the connection terminals have numbers for identifying the connections. You will find the associated figures in each case at the same place in the circuit diagrams, for example each of the figures quoted in the second place belong to one possible connection method.

Measurement ground (-) and the (module) supply voltage are electrically isolated in the module. NC signifies "No Connection". The plugs for the A128 module are 5-way plugs with push-in spring technology, i.e. you can insert a solid wire or a fine-stranded wire with a wire-end sleeve directly without screwing (max. 1.5 mm²). With a screwdriver press on the white opener to remove the connection.

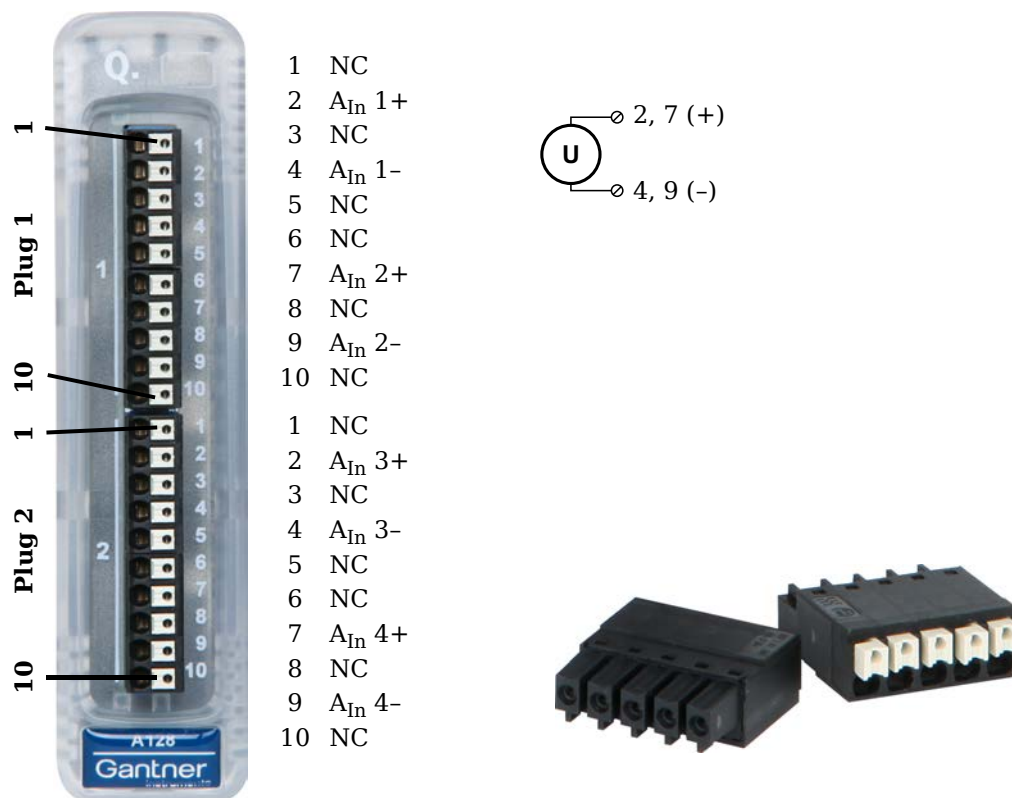

Fig. 4-88 Pin assignment and plugs for the Q.bloxx module A128.

i Tip

Further information on transducers and sensors can also be found in Chapter 6 ff. page 135.

4.22.1**Voltage**

You can measure voltages of up to $\pm 1200V_{DC}$. Here, various input voltage ranges from $\pm 40V_{DC}$ to $\pm 1200V_{DC}$ are possible.

NOTICE

Voltages above 1200V can damage the module.

Each module is tested with a test voltage of $5kV_{DC}$ for one minute. A longer duration or a higher voltage can damage the module. In addition, each period of overvoltage reduces the service life of the module.

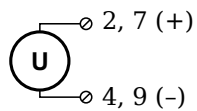

Fig. 4-89 A124, voltage measurement.

! IMPORTANT

Voltages which exceed the admissible limits give incorrect measurement data, because the input voltage is internally limited.

4.23

Q.bloxx D101: Connecting I/O

The Q.bloxx Module D101 has eight digital inputs and eight digital outputs. The pin assignment of the two connector strips is identical and the connection terminals have numbers for identifying the connections. You will find the associated figures in each case at the same place in the circuit diagrams, for example each of the figures quoted in the second place belong to one possible connection method.

The designations 0 V and +V refer to the (external) supply voltage connections.

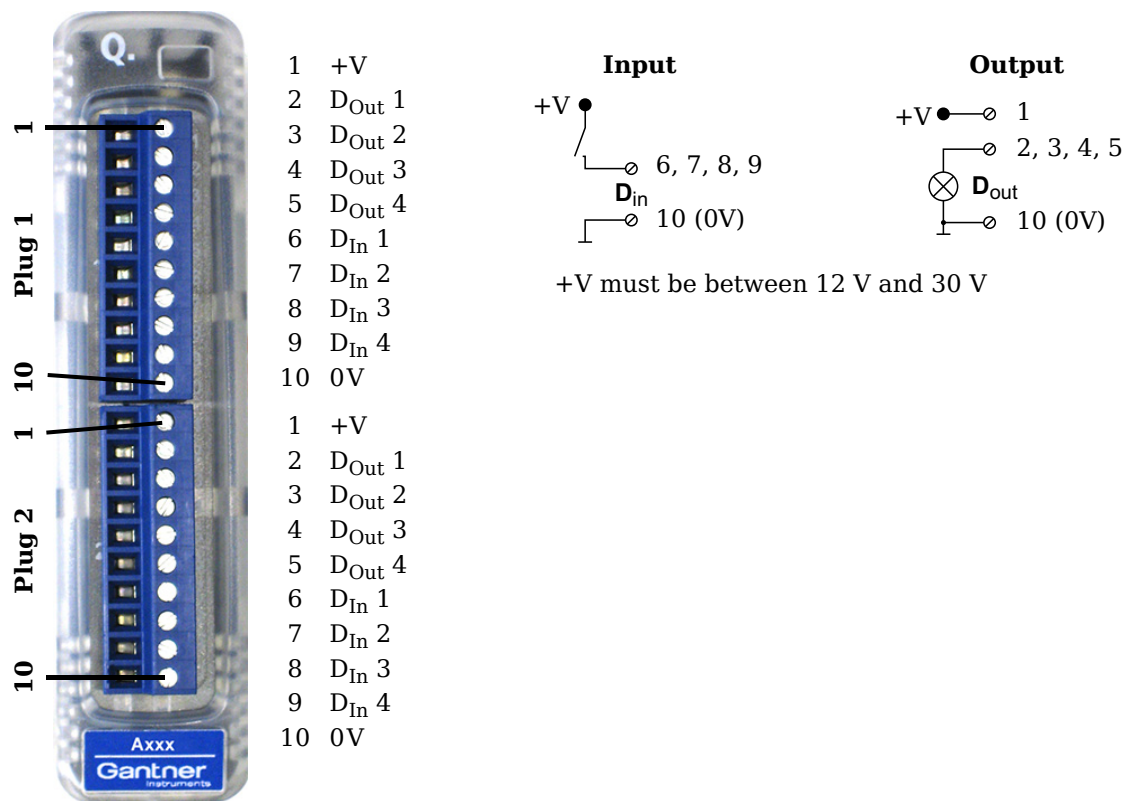

Fig. 4-90 Pin assignment for Q.bloxx Module D101.

4.23.1

Digital input and output

On each connecting plug contacts for four inputs and four outputs are available. Since the inputs and outputs of this module are electrically isolated from the supply voltage, you must also connect 0V for the inputs and 0V and a supply voltage (+V) for the outputs.



Fig. 4-91 D101, digital input and output.

The digital input is active (high level) when the applied signal voltage lies above the (programmable) threshold.

The following table shows possible combinations of contact assignments for the inputs:

Plug.Contact							
1.6	1.7	1.8	1.9	2.6	2.7	2.8	2.9
Status	Status	Status	Status	Status	Status	Status	Status
Status	Status	Status	Status	Status	Status	2-channel signal ¹⁾	
Status	Status	Status	Status	2-channel signal ¹⁾		2-channel signal ¹⁾	
Status	Status	Status	Status	4-channel signal ²⁾			
Status	Status	2-channel signal ¹⁾		2-channel signal ¹⁾		2-channel signal ¹⁾	
Status	Status	2-channel signal ¹⁾		4-channel signal ²⁾			
2-channel signal ¹⁾		2-channel signal ¹⁾		4-channel signal ²⁾			
2-channel signal ¹⁾		2-channel signal ¹⁾		2-channel signal ¹⁾		2-channel signal ¹⁾	
4-channel signal ²⁾				4-channel signal ²⁾			
8-channel signal ³⁾							

- 1) e.g. counter with additional input for counting direction or 2-phase counter signals or frequency measurement with direction detection (torque transducers)
- 2) e.g. counter with additional inputs for counting direction, zero reference and reset/enable for zero reference
- 3) e.g. sensors with binary coding

The following block diagrams give you an overview of the possible circuits.

**Measurement of status, time, frequency or PWM
(Pulse-Width Modulation), 1 signal**

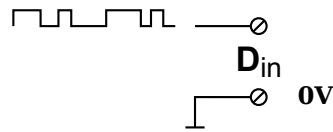

**Up/down counter or measurement of frequency and direction with
static direction signal, 2 signals**

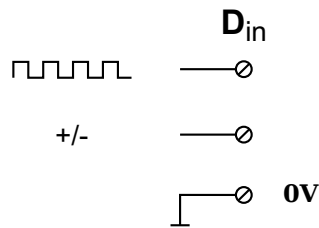

**Measurement of frequency and direction or up/down counter with
2-channel frequency signal (90° phase delay)**

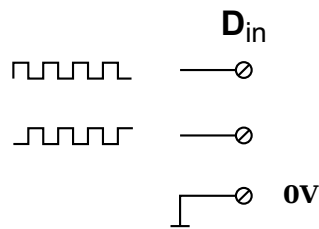

**Measurement of frequency and direction or up/down counter with
4-channel frequency signal**

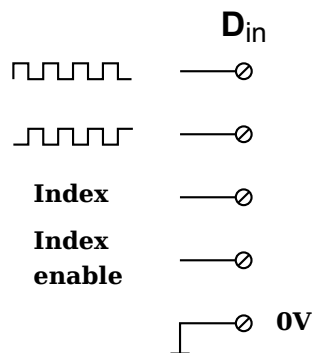

4.24

Q.bloxx D104: connecting digital inputs

The Q.bloxx Module D104 has sixteen digital inputs. The pin assignment of the two connector strips is identical and the connection terminals have numbers for identifying the connections. You will find the associated figures in each case at the same place in the circuit diagrams, for example each of the figures quoted in the second place belong to one possible connection method.

The designations 0 V and +V refer to the (external) supply voltage connections, NC indicates “not assigned”.

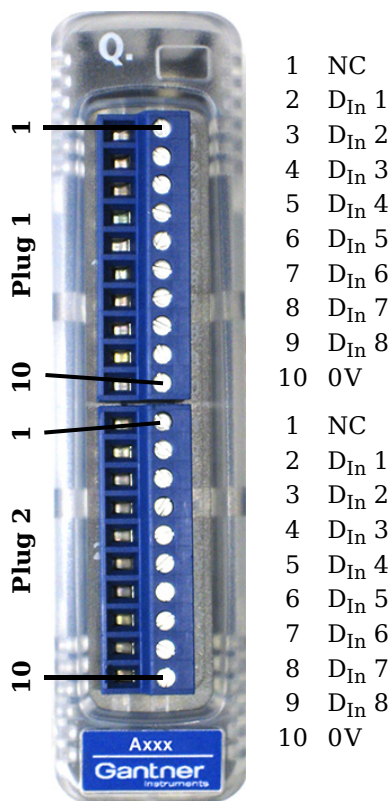

- 1 NC
 - 2 D_{In} 1
 - 3 D_{In} 2
 - 4 D_{In} 3
 - 5 D_{In} 4
 - 6 D_{In} 5
 - 7 D_{In} 6
 - 8 D_{In} 7
 - 9 D_{In} 8
 - 10 0V
-
- 1 NC
 - 2 D_{In} 1
 - 3 D_{In} 2
 - 4 D_{In} 3
 - 5 D_{In} 4
 - 6 D_{In} 5
 - 7 D_{In} 6
 - 8 D_{In} 7
 - 9 D_{In} 8
 - 10 0V

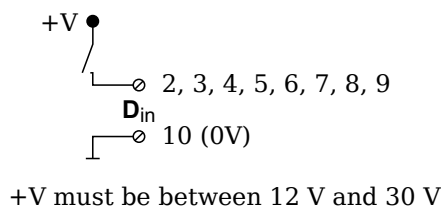

Fig. 4-92 Pin assignment for Q.bloxx Module D104.

4.24.1

Digital input

On each connecting plug contacts for eight inputs are available. Since the inputs of this module are electrically isolated from the power supply, you must also connect 0V and a supply voltage (+V).

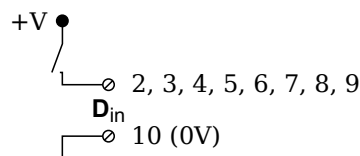

Fig. 4-93 D104, digital input.

The digital input is active (high level) when the applied signal voltage lies above the (programmable) threshold.

4.25

Q.bloxx D105: connecting digital outputs

The Q.bloxx Module D105 has sixteen digital outputs. The pin assignment of the two connector strips is identical and the connection terminals have numbers for identifying the connections. You will find the associated figures in each case at the same place in the circuit diagrams, for example each of the figures quoted in the second place belong to one possible connection method.

The designations 0 V and +V refer to the (external) supply voltage connections.

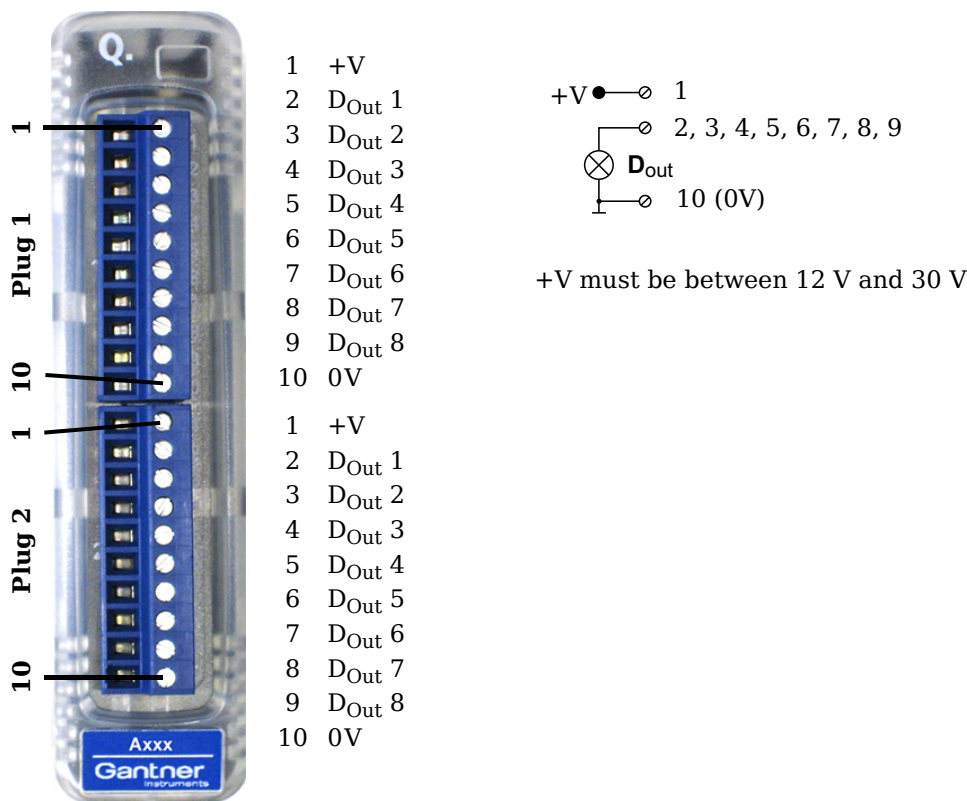

Fig. 4-94 Pin assignment for Q.bloxx Module D105.

4.25.1

Digital output

On each connecting plug contacts for eight outputs are available. Since the outputs of this module are electrically isolated from the power supply, you must also connect 0V and a supply voltage (+V) for the outputs.

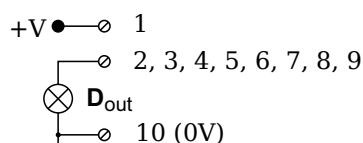

Fig. 4-95 D105, digital output.

4.26

Q.bloxx D107: Connecting digital inputs

The Q.bloxx Module D107 has sixteen digital inputs. The pin assignment of the two connector strips is identical and the connection terminals have numbers for identifying the connections. You will find the associated figures in each case at the same place in the circuit diagrams, for example each of the figures quoted in the second place belong to one possible connection method.

The designations 0 V (GND) and +V refer to the supply voltage connections for supplying the sensors. NC signifies “No Connection”. Both terminals are electrically isolated from one another and from the module supply voltage.

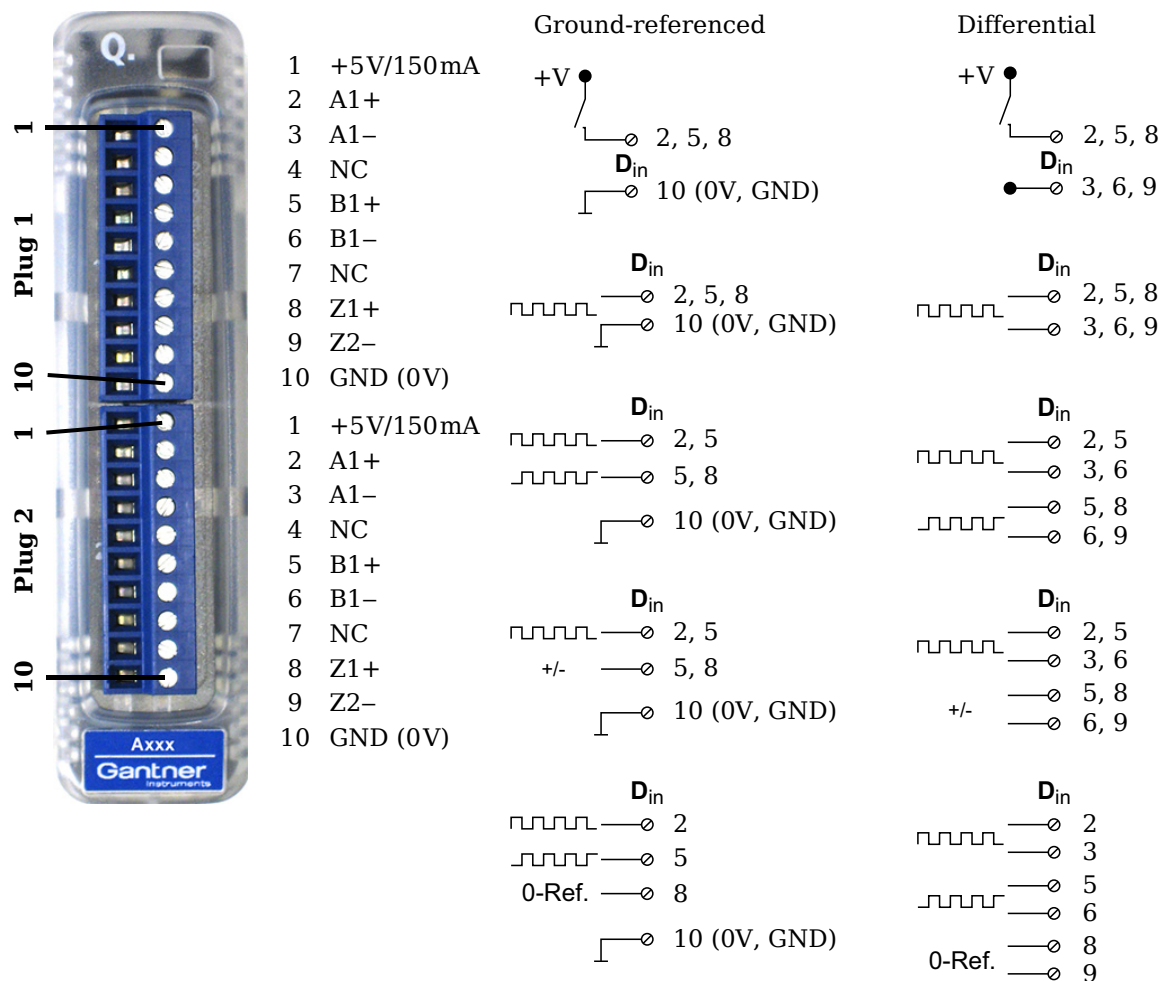

Fig. 4-96 Pin assignment and circuit variants for the Q.bloxx Module D107.

4.26.1

Digital input

On each connecting plug contacts for three inputs are available. You can use the inputs as a differential input or as a ground-referenced (single-ended) input. Since in each case the inputs termi-

nals are electrically isolated from one another and from the supply voltage, you also have to connect GND (0V) even with differential inputs.

A supply voltage (+V) of 5V and max. 150mA per terminal is available for supplying the connected sensors.

The digital input is active (high level) when the applied signal voltage lies above the threshold. In the differential measurement mode the threshold can be set in 256 steps between -20V and +20V, otherwise between 0V and +26V.

The following table shows possible combinations of contact assignments for the inputs on Plug 1 (Dx = Sensor x):

Operating mode	Plug.Contact (assignment)						
	1.2 (A1+)	1.3 (A1-)	1.5 (B1+)	1.6 (B1-)	1.8 (Z1+)	1.9 (Z1-)	1.10 (0V)
3 x standard ¹⁾ , differential	D1 ₁ +	D1 ₁ -	D2 ₁ +	D2 ₁ -	D3 ₁ +	D3 ₁ -	GND
3 x standard, single-ended	D1 ₁ +	—	D2 ₁ +	—	D3 ₁ +	—	GND
1 x 2 sensor signals ²⁾ + 1 x standard, differential	D1 ₁ +	D1 ₁ -	D1 ₂ +	D1 ₂ -	D2 ₁ +	D2 ₁ -	GND
1 x 2 sensor signals + 1 x standard, single-ended	D1 ₁ +	—	D1 ₂ +	—	D2 ₁ +	—	GND
1 x 3 sensor signals ³⁾ , dif- ferential	D1 ₁ +	D1 ₁ -	D1 ₂ +	D1 ₂ -	D1 ₃ +	D1 ₃ -	GND
1 x 3 sensor signals, sin- gle-ended	D1 ₁ +	—	D1 ₂ +	—	D1 ₃ +	—	GND

1) e.g. status input, frequency measurement or counter

2) e.g. counter with additional input for counting direction (forwards/reverse counter) or 2-phase counter signals (quadrature counter) or frequency measurement with direction detection (torque transducers)

3) e.g. 2-phase counter signal or angle sensor with additional input for zero reference

The following illustrations show examples for the connection of various sensors. Here, in each case only one sensor and one variant is shown. For example, for the sensor in Fig. 4-98 or Fig. 4-99 you can also use connections 5/6 and 8/9 and the connections 2/3 for a standard sensor or digital input. The connection of a single digital input is not considered in illustrations. If you are connecting more than one sensor per terminal, you can mix ground-referenced and differential configurations.

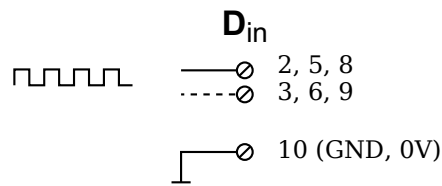

Fig. 4-97 D107, sensor with one signal, single-ended or differential (input broken line).

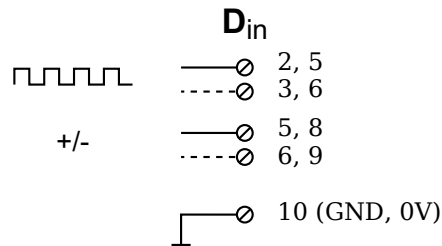

Fig. 4-98 D107, sensor with two signals (counting direction), single-ended or differential (input broken line).

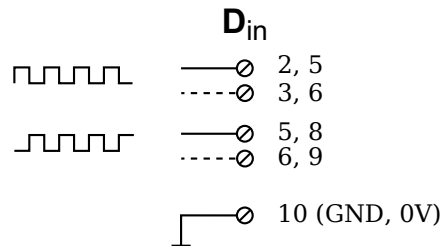

Fig. 4-99 D107, sensor with two signals (90° offset), single-ended or differential (input broken line).

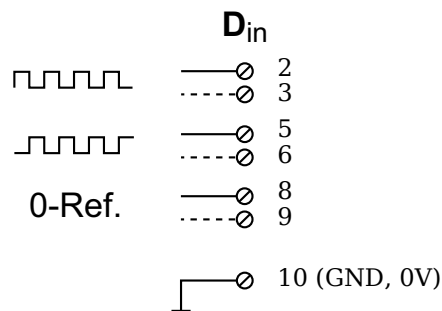

Fig. 4-100 D107, sensor with three signals (2 x 90° offset and zero reference), single-ended or differential (input broken line).

5

Configuration

You must first establish contact with the module before you can configure it. Use the program `test.commander` for this purpose if a Q.gate- or a Q.pac Test Controller is present. Otherwise, use the program ICP 100 for the configuration.

A license number is needed which you have to enter to be able to save configurations. During the installation of `test.commander`, the software ICP 100 is also installed and, with the licensing of `test.commander`, is also enabled. You will find the license numbers in the PDF file enclosed with the supplied items and on the separate printout with your license data.

The manuals and online help for the programs provide a comprehensive description of all program options. The following describes the most important settings to obtain a system suitable for acquiring measurements.

i Tip

Use the `test.commander` Wizard for the initial setup.

If you already have a configuration file with the required settings available, you can load this file into the relevant module with the Program Controller Setup Wizard (included in `test.commander`) or ICP 100.

! IMPORTANT

If you would like to combine modules or Test Controllers from older applications and recently purchased ones, all components should use the latest relevant internal software, the so-called firmware. To ensure this, carry out a firmware update; refer to Section 5.10, page 132.

Basic procedure

- Establish the connection (communication) between the PC and module or Test Controller.
- Start the configuration program.
- Enter the sensors used and their sensitivities to obtain an indication in the measured physical quantity.
- Define computations, digital inputs/outputs, alarm monitoring, etc.
- Activate all settings in the module and Test Controller.

i Tip

At many points in the programs you can call the setting dialogs or settings via the context menu of an entry. You call the context menu with the right mouse key.

5.1

Installing the test.commander

- ➔ We recommend that you close all open programs before the installation.

Insert the Gantner CD into your CD drive. In the standard configuration Windows opens the CD automatically and a start window appears. If you have deactivated the Windows autostart function, find the file StartUp.exe in the main directory on the CD and give the corresponding symbol a double click to obtain the start window. Alternatively, you can also start the program Setup.exe in the folder test.commander to carry out the installation directly.

- ➔ The program ICP 100 is installed together with the program test.commander.

You will also find the relevant latest versions of the programs on our home page www.gantner-instruments.com via **Software > Download**.

Procedure

- Click on the symbol over **Load software**.
- Click on the symbol  next to the program which you want to install.
The program Setup.exe is started.
- Allow the file to open so that the installation can start.
The starting dialog of the setup program appears.
- Follow the instructions of the setup program to define the installation directory and the program group for the software.
Setup.exe creates the directory you have specified, if necessary and then copies all files to it.

When the program test.commander is started for the first time, you specify the language for the program user interface (you can change your selection at any time via **Extras > Settings > Language**).

Then enter your license data via **Help > Info and Licensing**. If you have licensed the program test.commander, then the program ICP 100 is also enabled and a further license is not required.

5.2

Using test.commander

You can use the program test.commander, when a Q.gate or Q.pac Test Controller is present in your configuration. For the configuration no module or Test Controller needs to be connected; you can carry out the configuration also off-line. For initial operation we recommend though that all modules are connected. Since when using Test Controllers more than one module is usually present, you must namely also specify the addresses of the individual modules if this does not take place through the DIP switches in the module bases (refer to Section 4.1.2, *Setting the address (optional)* on page 23). The procedure for setting addresses via software is described in Section 5.2.1.

5.2.1

Linking test.commander via Ethernet (TCP/IP)

In order to be able to communicate with the Q.bloxx modules via Ethernet, you need to have a Q.gate or Q.pac Test Controller available to which the relevant modules are connected.

i Tip

Use the serial interface (refer to Section 5.2.2, page 105), if a permanent IP address (no DHCP) has already been set on the Q.gate or Q.pac Test Controller, but you no longer know what it is. Other than that, you cannot establish any link between the module and PC with “incorrect” address ranges.

Procedure

1. Connect the PC and Q.gate or Q.pac Test Controller via the Ethernet interface.
2. Start the program.
Now you have two options: Either you can use the Initial Operation Wizard or you can close the starting dialog with **Cancel** and proceed as described in the following. If you want to use the wizard, then simply follow the instructions in the dialog.
3. Call the program for configuration via the menu **Utilities > Module Setup Wizard**.
4. In the program window and using the menu **Options > Communication settings**, specify the setting **TCP/IP via controller** as the **Interface type** and activate **Use scan for IP addresses**.

For the Ethernet address you can either execute a scan in the address range of the PC interface (a UDP Scan¹ is executed) or directly enter a single address of Q.gate or Q.pac. If

¹⁾ With the UPD Scan all devices in a network are addressed simultaneously. The scan is therefore executed very quickly.

required, ask the network administrator to enable these scan methods and access of the program through the firewall to the Test Controllers.

If you use, e.g. 15 seconds, for the **Add. (itional) timeout**, an attempt to establish connection is interrupted after this period. The option only needs to be used for very slow networks or links via radio, etc.

5. Search for the modules: **Find modules**.

If you receive a firewall message during the search, you have to allow access to the Program Setup Wizard in order to be able to establish a connection (requires administrator rights), refer also to Section 6.2.3, *Allowing access to network devices (firewall)*, page 141.

First the Test Controllers found are displayed after the search. Mark the Test Controller to which the modules to be set are connected and click on **OK**. The Test Controller is addressed and the modules which have been found connected to it are displayed in a list. If there are addressing conflicts, you obtain a warning and the relevant modules are highlighted in red in the list. In this case click the column with the address and select a different address if you are assigning addresses via software. Assign unique addresses to all modules and click on **Write changes**. Having made the change, again execute **Find modules**.

i Tip

Assign the addresses starting with a number higher than 1, e.g. starting with 3. You can then integrate new modules more easily later, because the factory setting of the address in the modules is always 1.

If the addresses have been configured via the DIP switch in the base, when address conflicts occur, check the settings (Section 4.1.2, *Setting the address (optional)*, page 23).

If files with the module settings exist, you can transfer them to the marked modules using **Configure selected modules**. Otherwise, create a project for the configuration (Section 5.2.3).

! IMPORTANT

If, when reading out the module settings via the Test Controller (step 5.), the message appears that the firmware version of the Test Controller or of a module is older than expected, then you should carry out a firmware update; refer to Section 5.10, *Firmware update*, page 132.

5.2.2

test.commander and the serial (service) interface

test.commander uses the serial interface exclusively as a service interface for the Q.gate Test Controller or Q.pac Test Controller to set the IP address for Ethernet. Setting connected modules is not possible via this interface.

Procedure

1. Connecting the PC and module via the interface.
Use the supplied cable with the jack plug for the connection to the PC interface; refer also to Section 4.4.4, page 35.
2. Start the program¹.
3. Using the menu **Utilities**, call the menu item **Controller Setup Wizard**.
4. In the program window using the menu **Options > Communication Settings**, specify the setting **RS232 direct connection** as the **interface type** as well as the PC **COM port** used.
5. Call the program for the settings via the menu **Utilities > Controller serial terminal**.

The program searches the above specified interface for the Test Controller and presents you with a dialog in which you can read out the existing settings (**Read**) or set a new Ethernet address (and subnet mask) or DHCP (**Write**).

¹⁾ If you are not initially creating a project, close the starting dialog with **Cancel**.

5.2.3

Creating a project for configuration

A project contains the hardware setup, the sensor and I/O settings present in the modules as well as the sensor signals used and computations, the so-called variables, which are to be output.

Procedure

1. After the start of the test.commander you are offered several options. Select **Open new project and read in online system.**

The network to be searched is defined when the link is established; refer to Section 5.2.1 to Section 5.2.2, ff. page 103.

Alternatively, you can also create a project in the test.commander with **File > New project** and specify the Test Controller used via the context menu **Add online controller.**

2. In the dialog mark the Test Controller to which the modules to be set are connected and click on **OK.**

The existing module settings are read out and the Test Controller information updated via the connected modules. Confirm any changes to be made in order to retain the current state.

3. A dialog finally shows you that all settings have been successfully read from the Test Controller. Acknowledge this with a click on **OK.**

In your project the selected Test Controller is now displayed as the main entry. A tree structure similar to that in Windows Explorer shows the connected (found) Q.bloxx modules and the variables used. Open up the entries as required by a click on . Mark a module and select **Configuration** from the context menu or double click on a module or signal (variable) to start the configuration program ICP 100. Then carry out all the module settings in the window of this program.

IMPORTANT

After changes to the configuration of modules or a Test Controller  is displayed in the project tree. Select  or **File >**

Write project (update) in the test.commander to update the settings in the project (and in the Test Controller). The project file is in this case automatically saved.

Tip

You process a complete variable in the configuration dialog in that you click on the variable in the left column (contains the vari-

able number Vx) to mark it. Using the context menu, you can then cut, paste and copy the variable, overwrite it with a copied variable or delete it.

5.3

Configuring analog inputs

5.3.1

Setting sensor parameters

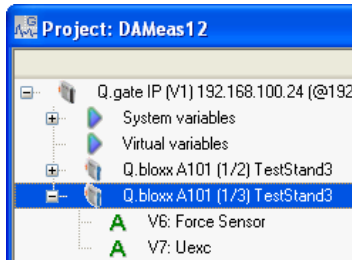

In order to set parameters you should be connected to the module and have called the configuration program (ICP 100 which is started automatically by test.commander): Mark a module and select **Configuration** from the context menu or double click on a module or module signal (variable) to start the configuration program. Then carry out all the module settings in the window of this program.

You can however also configure a project without a direct connection and then, once you have established the connection, load the corresponding files into the modules and load Test Controller.

All module signals are defined as variables. Therefore, for the entry activate the tab **Variable definition** in the configuration program.

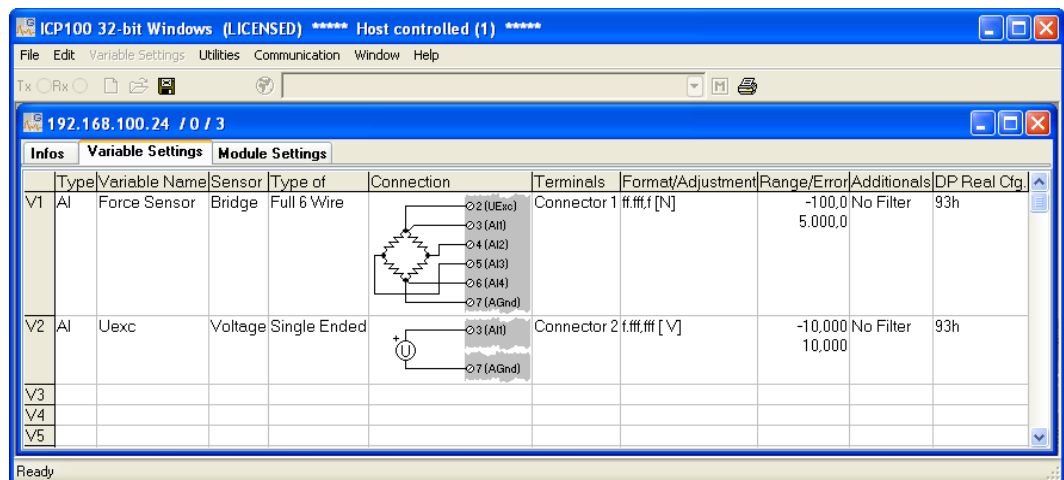

Fig. 5-1 Dialog with the configuration for force transducers (6-wire) and voltage input.

Procedure

1. Click in the column **Type** of the first row (V1 = Variable 1) or mark the row (click on V1) and use **Variable definition > Type**.
2. Select **Analog. Input**.
3. Click in the column **Variable name** and allocate a name identifying the signal from the connected sensor.
4. Click in the column **Sensor** and specify the type of sensor.

Depending on the type of module, you have various options available, e.g. **Bridge** for strain-gauge full and half-bridges, **Pt100, Resistance** for resistors or **Voltage** for voltage measurements and IEPE sensors.

5. Click in the column **Type of** and specify the type of circuit or further information about the sensor type.

Depending on the selected sensor type, you have various options available, e.g. **2-wire** or **4-wire** (circuit) for resistive transducers or **Full 4-wire** or **Full 6-wire** (circuit) for strain-gauge full bridges.

The column **Wiring diagram** shows you the pin assignment to be used. With more than one input the first inputs are also always occupied first (and first Plug 1, then Plug 2, etc.). Check that your sensor is connected correctly.

6. Click in the column **Format/balance** to enter the scaling for the sensor.

Depending on the type of sensor selected, you have various options available (refer also to Section 6.4, *Sensor scaling*, page 144):

- For voltage signals specify the conversion of the measured voltage to the physical quantity measured by the sensor or output the measured voltage quantity without conversion (scaling).
- For thermocouples or Pt100 sensors no further scaling is required as the conversion into °C is made automatically. The scaling is only needed when you want to convert to °F or K. In this case enter the **Unit** (type into the field) and then click on **Scaling**. Using the method **Factor and offset**. For a display in °F enter the factor **1.8** and **32** as the offset. For a display in °K enter the factor **1** and **-273.15** as the offset.
- For full and half-bridge transducers you can obtain the data from the data sheet or (better) from the transducer calibration certificate. For a force transducer with, for example, 2.03mV/V at 5kN enter the **Unit** (type **kN** in the field) and then click on **Scaling**. Using the method **2-point calibration**. Enter in each case **0** for **Point 1** for **Measurement** and **Displayed value** and **2.03** as **Measurement** and **5** as **Displayed measurement** for **Point 2**.
Alternatively, you can also enter **N** as **Unit** and then **5000** as **Displayed value** for **Point 2**.
- For strain gauges you have the **Strain gauge calculator** available. Here, the unit is automatically changed to $\mu\text{m}/\text{m}$. In the dialog enter the gauge factor of your strain

gauge (left field) and the bridge factor (right field) for your circuit.

Floating point numbers are always transferred as 4-byte values and further setting is not necessary here.

For the formats **Integer** (2 bytes) and **Long integer** (4 bytes) specify the number of **Decimal** places and the total number of places to be output (**Field length**). The field length is calculated including the points, but without any commas displayed for the thousands positions and it is only used for representation in one of the Gantner programs. Specifying three decimal places displays, for example, the value 1234 as 1,234. After closure of the dialog the number of transferred places and the unit are displayed in the column **Format/balance**, e.g. **ff,fff.f [kN]** for an output in the unit kN with a total of seven characters with one decimal place and the decimal point.

If negative numbers occur, the display in this example is limited to -9,999.9 (seven characters without the comma).

7. Click in the column **Range/error** to limit the admissible value range and to define the reaction in the case of an error (optional).
8. Also optionally, you can specify filtering of the sensor signal in the column **Other**.
9. Save the changes in a file and close the module once you have made all the changes:  or **File > Save to file and finish**. The file is created within the project folder and the file name is generated automatically. The project folder bears the same name as the project. The generated file name contains the address of the Test Controller through which the module is connected and an identifier for the relevant module.

IMPORTANT

If the modules are connected through a Test Controller, new module settings must also be updated there. Select  or **File > Write project (update)** in the test.commander. The project file is in this case automatically updated.

5.3.2

Carrier frequency synchronization (Q.bloxx A106)

The A106 module supports the supply of sensors with direct voltage (DC) or carrier frequency (CF).

- ➔ If you are using several modules of this type and set carrier frequency supply, you should synchronize the carrier frequencies of the modules, because otherwise crosstalk can occur between the

supply lines and the signal inputs of different modules. This then leads to beats in the measurement signal.

After selecting a carrier frequency, you have three methods of supply:

1. No sync.(hronization)

This setting is practicable when you are only using one module with carrier frequency supply. Within a module all carrier frequency generators are automatically synchronized.

2. Internal sync.(hronization)

Set this type of synchronization for *one* module. The module then becomes the master to which all other modules synchronize.

3. External sync.(hronization)

Specify this type of synchronization for all other modules so that they synchronize to the master.

For synchronization the Sync A and Sync B lines in the socket are used (Fig. 4-6, page 29).

i Tip

We recommend that only one variant of the carrier frequency is used, i.e. do not mix 600 Hz and 4800 Hz.

Do not forget to save these settings in the module and the Test Controller (refer to Section 5.3.1, *Setting sensor parameters*, page 107).

5.3.3

Zero balancing/taring the sensor

You have two ways of setting a measurement offset to zero, e.g. due to preloads:

1. Zero balance

With this method measurement takes place over a certain time period and the mean is computed. This mean value is then subtracted from all the following measurements.

2. Taring

With this method the (single) measurement present at a certain point in time is subtracted from all the following measurements.

You can, for example, perform the zero balance when setting up or control it using a variable.

Procedure
(control using a variable)

1. Click in the column **Type** of the first free row (V3 = Variable 3 in Fig. 5-2) or mark the row (click on V3) and use **Variable definition > Type**.
2. Select **Default**.
3. Click in the column **Variable name** and allocate a name specifying the purpose of the signal, e.g. Zero_tare (Fig. 5-2).

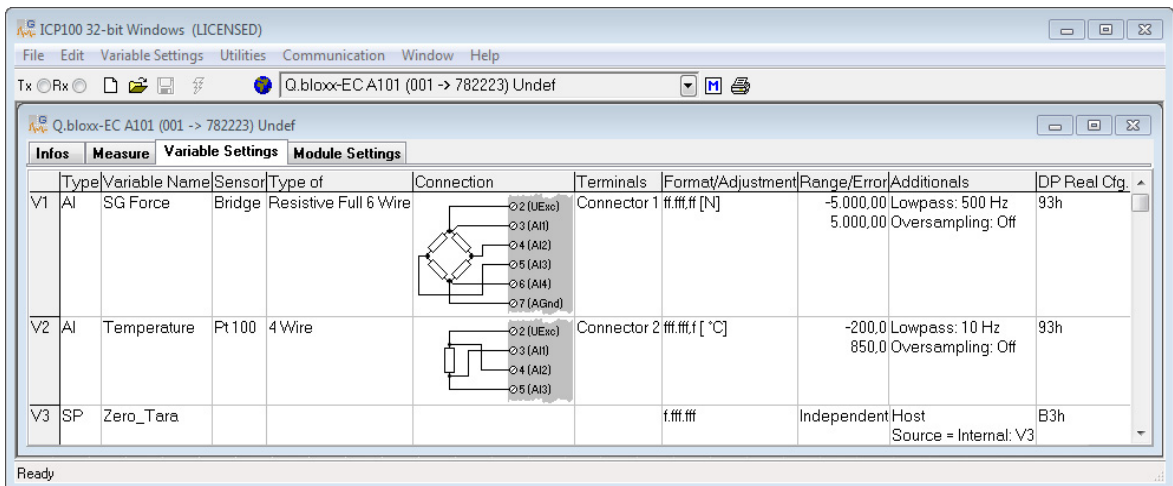

Fig. 5-2 Defining the variable for zero balancing and/or taring.

4. Click in the column **Format/balance** of the channel for which zero balancing and/or taring is to be executed, e.g. for the strain-gauge force sensor in Fig. 5-2.

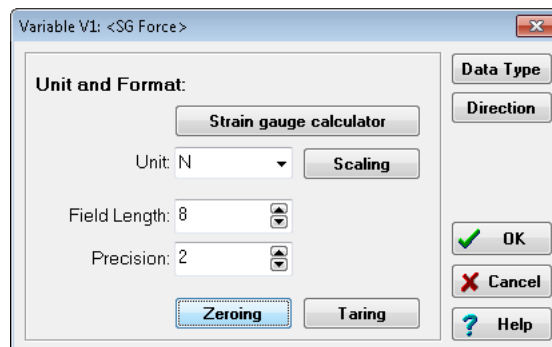

Fig. 5-3 Dialog for sensor scaling.

5. Click on **Direction** and specify **Input/Output** for the channel so that control is possible (Fig. 5-3).
6. Click on **Zero balance** or **Tare** to configure the relevant process (Fig. 5-3).
7. Select the variable created above as the control variable (Fig. 5-4).

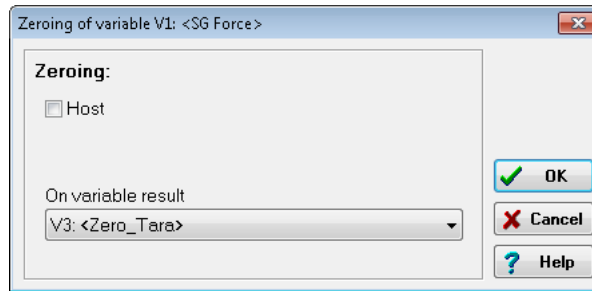

Fig. 5-4 Setting up zero balance or tare.

When the variable (Zero_tare in this example) has certain values, taring or zero balancing is carried out or an existing zero or tare value is deleted (undo zero balancing/taring):

Value	Function
1	Perform taring when setting the value
2	Reset tare (delete tare value)
4	Start zero balance The mean is formed until the value 0 is written to the variable again.
8	Reset zero balance (delete zero value)

Do not forget to save these settings in the module and the Test Controller (refer to Section 5.3.1, *Setting sensor parameters*, page 107).

5.3.4

Sensor scaling over several points (table)

In the standard setting (linear) sensors are scaled via a characteristic curve with two points. You can however also perform scaling over several points (table). During the measurement the values are then linearly interpolated between the specified points.

Procedure

1. Create the sensor as usual (two-point scaling).
2. In the **Sensor** column click on the sensor.
3. Copy the sensor (click on **Copy**) and specify a name, e.g. **ForceTable** (Fig. 5-5). If the scaling to be entered later only applies to this sensor, you should use the sensor type and the serial number as the name, e.g. **C2 #1234 (5V)**.

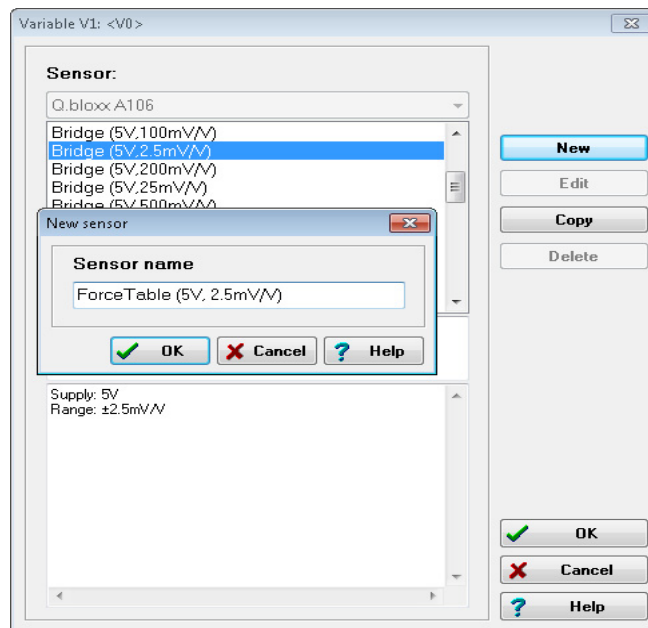

Fig. 5-5 Creating a new sensor for scaling.

4. Click on **Edit** and the **Unit** tab to be able to define the unit measured by your sensor (Fig. 5-6).

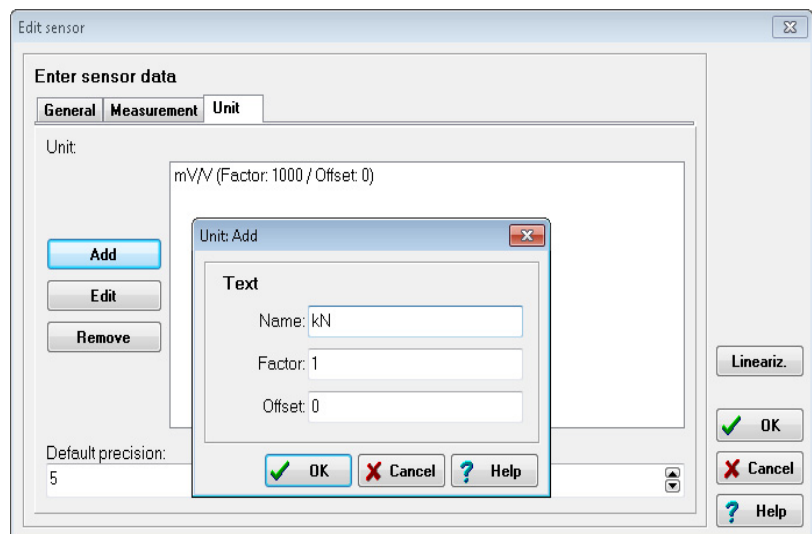

Fig. 5-6 Defining the unit for sensor scaling.

5. Specify the required unit, e.g. **kN** (Fig. 5-6).
6. Click on **Linearize** and select your unit.
7. Edit the existing values or generate further rows with **New** and specify the values for your sensor (Fig. 5-7). The rows are sorted based on the entered values.

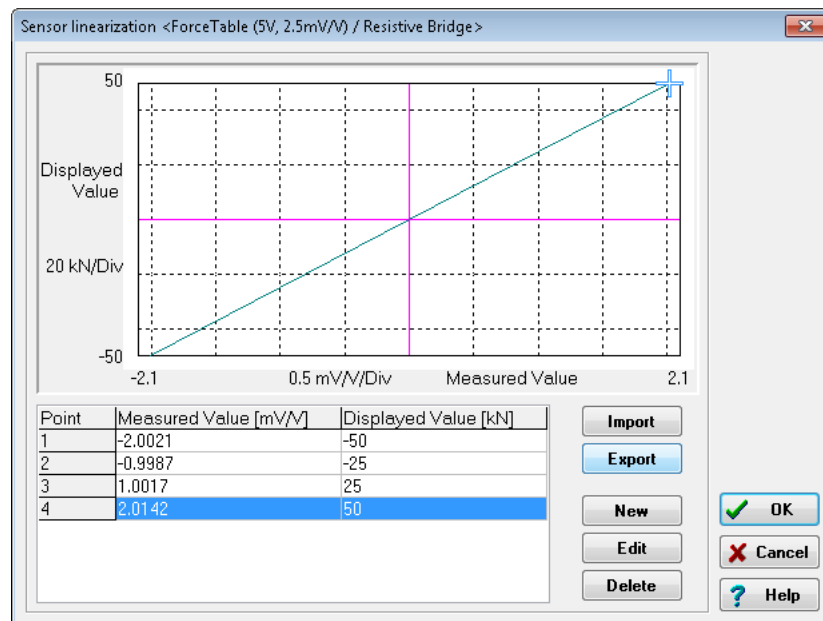

Fig. 5-7 Entering the scaling table.

If the data are present in an Excel file, you can also import a file in the format *Excel 97-2003-Workbook (*.xls)*.

Alternatively to entering a unit in step 5, you can leave the electrical unit of the sensor as it is and enter the table in this unit, e.g. *mV/V measured value* and *mV/V displayed value*. You can then define the unit displayed for the measurement in the **Format/balance** column.

Do not forget to save these settings in the module and the Test Controller (refer to Section 5.3.1, *Setting sensor parameters*, page 107).

5.4

Specifying digital inputs/outputs

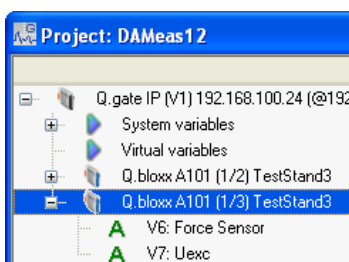

In order to set parameters you should be connected to the module and have called the configuration program (ICP 100 which is started automatically by test.commander): Mark a module and select **Configuration** from the context menu or double click on a module or module signal (variable) to start the configuration program. Then carry out all the module settings in the window of this program.

You can however also configure a project without a direct connection and then, once you have established the connection, load the corresponding files into the modules and load Test Controller. All module signals are defined as variables. Therefore, for the entry activate the tab **Variable definition** in the configuration program.

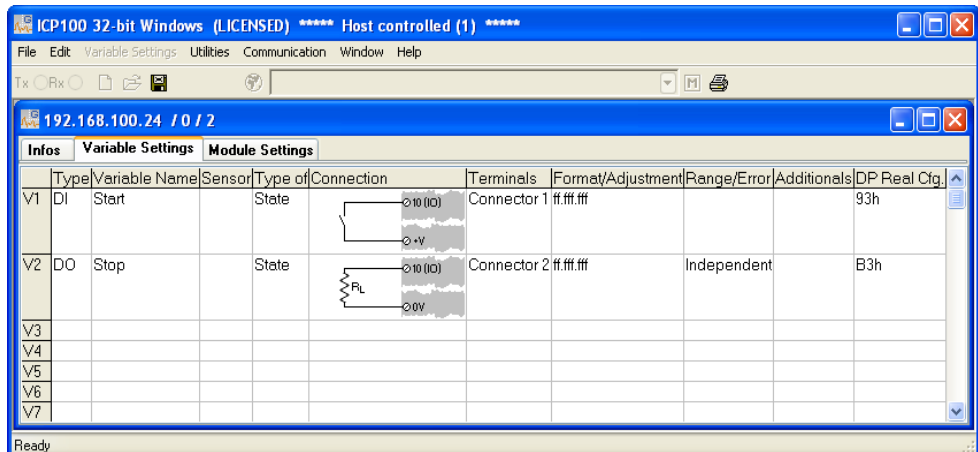

Fig. 5-8 Dialog with configuration for digital input and output.

Procedure

1. Click in the column **Type** of the first row (V1 = Variable 1) or mark the row (click on V1) and use **Variable definition > Type**.
2. Select **Digit. input** or **Digit. output**.
The column **Wiring diagram** shows you the pin assignment. With more than one input the first inputs are also always occupied first (first Plug 1, then Plug 2, etc.). Check for correct connection.
3. Click in the column **Variable name** and allocate a name identifying the signal.
4. At a digital **output** click in the column **Type of** and specify whether you want to use the output as **Status indicator**, **Status field** or **Process output**.

Process output: The output monitors a module signal and changes the output level under certain conditions. Click in the column **Other** and specify the type of alarm monitoring.

You can specify up to four alarm conditions. When one of the conditions is satisfied, the alarm signal is triggered.

To the left above the graphical displays select the levels at which switching is to occur and how they are to switch.

Enter the values for the switching thresholds in the (scaled) unit of the selected signal. Use either fixed values (constants) or arrange for the values to be determined by other variables.

Status indicator: The output can be set via a command from the Test Controller, e.g. via a PROFIBUS-DP command. Click in the column **Other** and specify the type of alarm monitoring.

5. Click in the column **Format/balance** to specify the transfer format.

Since digital signals do not require any **Decimal** places, you can enter **0** here. **1** is sufficient for the **Field length**. With a digital input you can also specify a unit (optional).

For several inputs/outputs and the type **Status field (Type of column)**, as well as the transfer as a number (e.g. as integer), there is also the type **Status field 32** with which all existing inputs or outputs are transferred as binary numbers. Define a suitable field length here depending on the number of inputs and outputs.

When the dialog is closed, the number of transferred places and the unit in the column **Format/balance** are displayed.

6. Click in the column **Range/error** to define the reaction in the case of an error for the digital outputs (optional).
7. Save the changes in a file and close the module once you have made all the changes:  or **File > Save to file and finish**. The file is created within the project folder and the file name is generated automatically. The project folder bears the same name as the project. The generated file name contains the address of the Test Controller through which the module is connected and an identifier for the relevant module.

IMPORTANT

If the modules are connected through a Test Controller, new module settings must also be updated there. Select  or **File > Write project (update)** in the test.commander. The project file is in this case automatically updated.

5.5

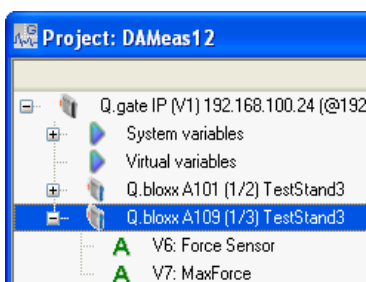

Configuring analog outputs

In order to set parameters you should be connected to the module and have called the configuration program (ICP 100 which is started automatically by test.commander): Mark a module and select **Configuration** from the context menu or double click on a module or module signal (variable) to start the configuration program. Then carry out all the module settings in the window of this program.

You can however also configure a project without a direct connection and then, once you have established the connection, load the corresponding files into the modules and load Test Controller. All module signals are defined as variables. Therefore, for the entry activate the tab **Variable definition** in the configuration program.

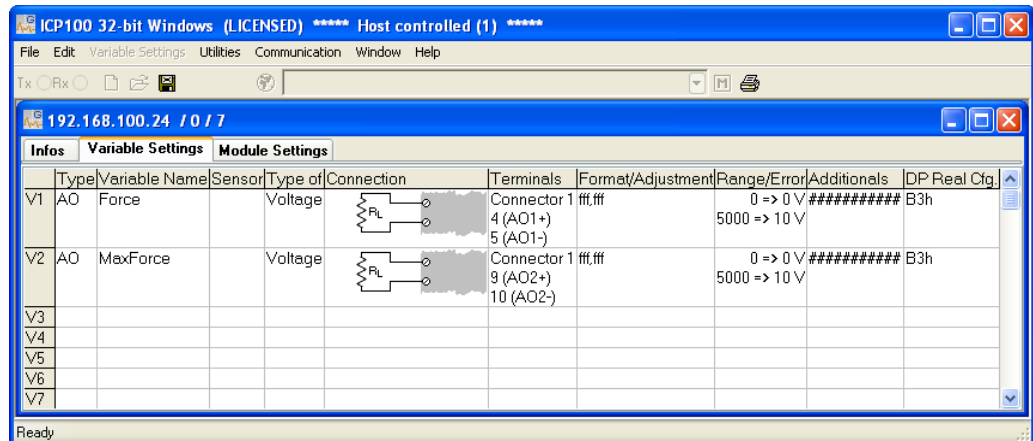

Fig. 5-9 Dialog with configuration for analog outputs.

Procedure

1. Click in the column **Type** of the first row (V1 = Variable 1) or mark the row (click on V1) and use **Variable definition > Type**.
2. Select **Analog. Output**.
The column **Wiring diagram** shows you the pin assignment. With more than one output the first outputs are also always occupied first (first Plug 1, then Plug 2, etc.). Check for correct connection.
3. Click in the column **Variable name** and allocate a name identifying the signal.
4. Click in the column **Type of** and specify whether you want to use the output as a **Voltage** or a **Current** output.
5. In the **Format/balance** column the output format is shown which has no further significance here.
6. Click in the column **Range/error** to define the output scaling and the reaction in the case of an error (optional).
7. Click in the column **Other** to specify the signal source (variable) used for the output.
8. Save the changes in a file and close the module once you have made all the changes: or **File > Save to file and finish**. The file is created within the project folder and the file name is generated automatically. The project folder bears the same name as the project. The generated file name contains the address of the Test Controller through which the module is connected and an identifier for the relevant module.

IMPORTANT

If the modules are connected through a Test Controller, new module settings must also be updated there. Select or **File**

> **Write project (update)** in the test.commander. The project file is in this case automatically updated.

5.6

Defining computations

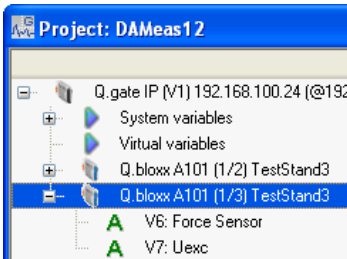

In order to set parameters you should be connected to the module and have called the configuration program (ICP 100 which is started automatically by test.commander): Mark a module and select **Configuration** from the context menu or double click on a module or module signal (variable) to start the configuration program. Then carry out all the module settings in the window of this program.

You can however also configure a project without a direct connection and then, once you have established the connection, load the corresponding files into the modules and load Test Controller.

All module signals are defined as variables. Therefore, for the entry activate the tab **Variable definition** in the configuration program.

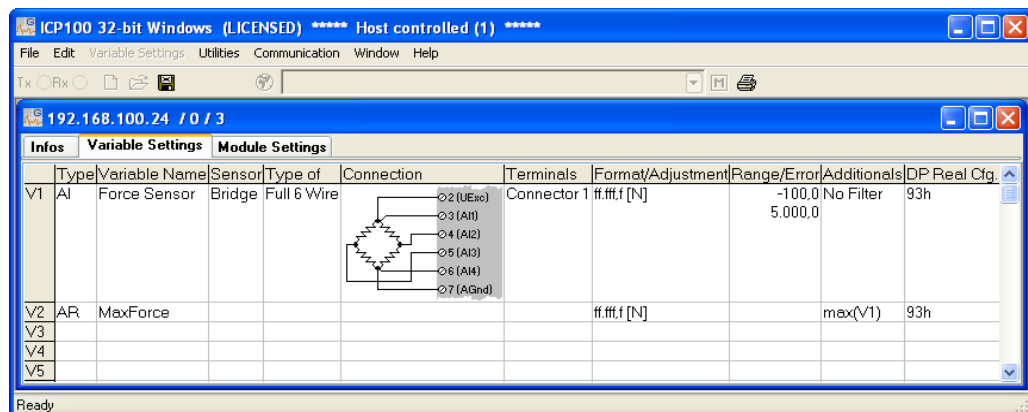

Fig. 5-10 Dialog with configuration for a computation.

Procedure

1. Click in the column **Type** of the first row (V1 = Variable 1) or mark the row (click on V1) and use **Variable definition > Type**.
2. Select **Arithmetic**.
3. Click in the column **Variable name** and allocate a name identifying the signal.
4. Click in the column **Other** and specify the required computation.

In the upper dialog field you can enter, as on a pocket calculator, a formula which uses the existing module variables. Create functions via the buttons in the lower section of the dialog. Click on **OK** once you have defined the required computation.

- Click in the **Format/balance** column to specify the transfer format using the formats **Integer** (2 bytes) and **Long integer** (4 bytes).

Floating point numbers are always transferred as 4-byte values and further setting is not necessary here.



For the formats **Integer** and **Long integer** specify the number of **Decimal** places and the total number of places to be output (**Field length**). The field length is calculated including the points, but without any commas displayed for the thousands positions and it is only used for representation in one of the Gantner programs. Specifying three decimal places displays, for example, the value 1234 as 1,234.

After closure of the dialog the number of transferred places and the unit are displayed in the column **Format/balance**, e.g. **ff,fff.f [kN]** for an output in the unit kN with a total of seven characters with one decimal place and the decimal point.

If negative numbers occur, the display in this example is limited to -9,999.9 (seven characters without the comma).

- Save the changes in a file and close the module once you have made all the changes:  or **File > Save to file and finish**. The file is created within the project folder and the file name is generated automatically. The project folder bears the same name as the project. The generated file name contains the address of the Test Controller through which the module is connected and an identifier for the relevant module.

IMPORTANT

If the modules are connected through a Test Controller, new module settings must also be updated there. Select   or **File > Write project (update)** in the test.commander. The project file is in this case automatically updated.

5.7

Specifying the alarm monitoring

In order to set parameters you should be connected to the module and have called the configuration program (ICP 100 which is started automatically by test.commander): Mark a module and select **Configuration** from the context menu or double click on a module or module signal (variable) to start the configuration program. Then carry out all the module settings in the window of this program.

You can however also configure a project without a direct connection and then, once you have established the connection, load the corresponding files into the modules and load Test Controller.

All module signals are defined as variables. Therefore, for the entry activate the tab **Variable definition** in the configuration program.

- ➔ In order to monitor a limit and to output a level on a digital output when an alarm occurs, you can directly use the function of the digital output. You do not need to set up any alarm monitoring. The alarm monitoring is used to monitor signals in the module and to make the result available to the PC or PLC as a preconditioned signal. Checking the original signal in the PC or PLC can therefore be omitted.

Procedure

1. Click in the column **Type** of the first row (V1 = Variable 1) or mark the row (click on V1) and use **Variable definition > Type**.
2. Select **Alarm**.
3. Click in the column **Variable name** and allocate a name identifying the alarm signal.
4. Click in the column **Other** and specify the type of alarm monitoring.

You can specify up to four alarm conditions. When one of the conditions is satisfied, the alarm signal is triggered.

To the left above the graphical displays select the levels at which switching is to occur and how they are to switch. Enter the values for the switching thresholds in the (scaled) unit of the selected signal. Use either fixed values (constants) or arrange for the values to be determined by other variables.

5. Click in the column **Format/balance** to specify the transfer format.

Since the alarm signal, like digital signals, does not require any **Decimal** places, you can enter **0** here. **1** is sufficient for the **Field length**.

When the dialog is closed, the number of transferred places and the unit in the column **Format/balance**, e.g. **f**, are displayed.

6. Save the changes in a file and close the module once you have made all the changes:  or **File > Save to file and finish**. The file is created within the project folder and the file name is generated automatically. The project folder bears the same name as the project. The generated file name contains the address of the Test Controller through which the module is connected and an identifier for the relevant module.

! IMPORTANT

If the modules are connected through a Test Controller, new module settings must also be updated there. Select  or **File > Write project (update)** in the test.commander. The project file is in this case automatically updated.

5.8

Q.gate and Q.pac settings

In the Test Controller you specify, for example, the type and scope of the synchronization, set the (synchronous) output rate and baud rate of the modules to be used or define which bus diagnostic data or life signs are to be transmitted. In addition, you can check all the settings of host and module interfaces, allocate a location name, etc. The following sections only deal with the most important settings; for further information read the appropriate Test Controller manual.

Mark the Test Controller to be set and select **Settings** from the context menu or double click on the Test Controller to start the configuration program. Then you can carry out all the module settings in the window of this program. A tree structure similar to that in Windows Explorer shows the individual parameter groups.

Open up the entries as required by a click on .

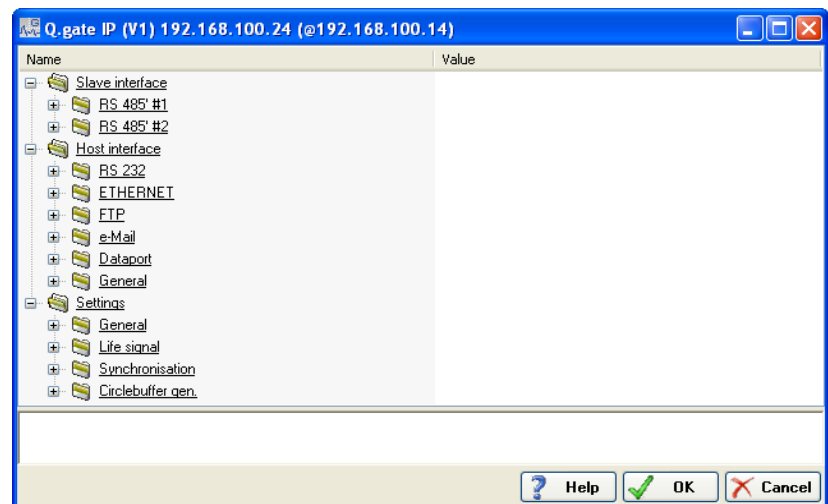
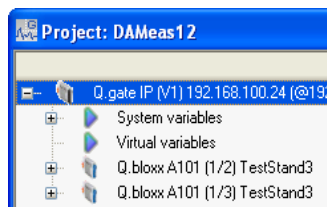

Fig. 5-11 Configuration dialog for a Q.gate. Test Controller

5.8.1

Module interface

Using this parameter group you specify the speed of the data transmission on the individual interfaces (UARTs). The maximum possible speed depends on the overall length of the cable which is connected to the relevant interface.

Cable length in meters	Maximum baud rate
1000	< 500 kBaud
100	< 1500 kBaud
20	< 6000 kBaud
10	>6 to 48 MBaud

A change in the baud rate is also carried out automatically on the modules connected to the interface.

Communication monitoring: With a value > 0 the module error LED is activated if there is a lack of communication after this period.

Response delay: This parameter is only needed when the modules are not directly connected to this interface, but instead connected to a modem, for example. Then enter the time here which is to be awaited additionally due to the slow connection.

5.8.2

Host interface

This parameter group defines the settings for communication with the host(s) (other Test Controllers, PC, PLC, etc.). Refer also to Time synchronization, page 123 (Section 5.8.3.3).

Since the Test Controller can also operate as an FTP server and FTP client, the settings for sending e-mails, for example, can also be defined here. Further information on these parameters can be found in the System Guide Manual.

5.8.3

Settings

Using this parameter group you define, for example, life signs or the location name. The parameters available are different for the Q.gate and Q.pac; the parameters only available with the Q.pac are appropriately labeled.

5.8.3.1

General remarks

Location

Here, assign a name for the Test Controller.

PAC functionality (only Q.pac)

Activates or deactivates the PAC functionality. With active PAC functionality only two ring buffers maximum (refer to Section 5.8.3.4, page 125) are available. The PAC functionality enables you to program more complex functions such as PID controllers, function generators, etc. via the software e.con, which can be graphically programmed.

Buffer pre-initialization

In the **Fast filling** default setting each measurement transferred with a bit error leads to an error: the measurement is set to -1 (default setting for **Filling pattern**) and the error counter is set. This generally causes the test-rig to stop. In the setting **Deactivated** the previous measurement is also used for the present measurement. If the next measurement is alright again, measurement continues as normal. The error is however counted, but no alarm is triggered.

Filling pattern

Value which is used for a defective measurement (refer to Buffer pre-initialization).

5.8.3.2

Life sign

Here you specify the communication errors for which an error signal is to be set and whether it is to occur as a static signal or dynamically (switching between on and off with the **I/O status cycle**).

5.8.3.3

Synchronization

Synchronous sampling frequency

If you are using several modules on various interfaces (UARTs), which operate at different sample rates, for example because not all modules support the same sample rate, then with this parameter you can ensure that those values transferred over an interface (UART) with a slow sample rate are also synchronized to the time points at which a measurement is also present that has been acquired with a fast sample rate (Fig. 5-12).

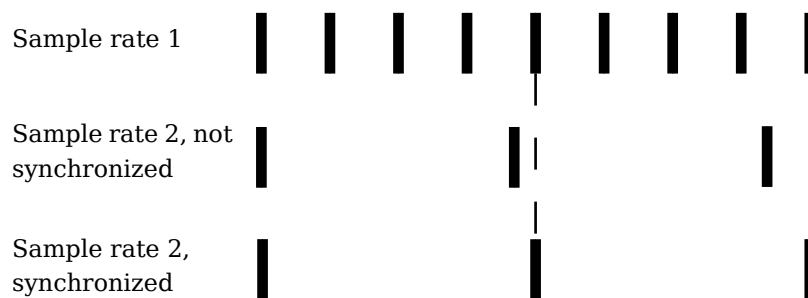

Fig. 5-12 Data transmission at a synchronous sampling frequency.

When using several Q.pac Test Controllers, additionally specify which is used as master (**Use as master: Yes**) and which are used as slaves. The master (only one master is permissible) defines the synchronization and then all slaves synchronize themselves to the master.

Time synchronization

If you want to use either several systems or to synchronize your system through an external time source, you must specify how the synchronization is to occur (refer also to Section 4.5, page 38).

1. Synchronization of several Q.pac Test Controllers through one sync line
 Connect the sync connections of the Test Controller through synchronization lines (plug-in terminal 2, connections 9 and 10; refer to Section 4.4.2, page 32). For this purpose use a screened cable with twisted cores if possible. One (any) controller becomes the master; on this controller set **Settings > Synchronization > Sync. protocol settings** to **None**. For the other Test Controllers specify **Q.sync over RS485** as the setting in the same dialog.
 The maximum length of all synchronization lines together is 1000 m.
2. Synchronization of a Q.pac Test Controller through a radio receiver for time signals
 Connect the receiver either via the digital IOs or via RS-485; refer to Section 4.5.1, page 41. Depending on the connection and output signal, specify **AFNOR via IOs**, **AFNOR via RS485**, **IRIG B003/B005 via IOs** or **IRIG B003/B005 via RS485** for **Settings > Synchronization > Sync. protocol settings**. The maximum length of the lines for connection via IOs is 3m.
3. Synchronization of a Q.gate or Q.pac Test Controller through a GPS receiver
 Connect the GPS receiver with the RS-232 interface of the Test Controller and specify **NMEA-0183** for **Host interface > RS 232 > Protocol**.
4. Synchronization of a Q.gate or Q.pac Test Controller through SNTP
 Make sure that the Test Controller can access a time server in the Ethernet network. Specify **On** for **Host interface > SNTP > SNTP mode** as well as the **Server address** (IP address of the time server).

All other variants are combinations of these four methods:

1. Synchronization of several Q.pac Test Controllers through one sync line; the master controller can be synchronized through radio receiver for time signals, a GPS receiver or SNTP.
 Set the master up as described above (**Settings > Synchronization > Sync. protocol settings** remains on **None**). On the slave controllers specify **Q.sync over RS485** for **Settings > Synchronization > Sync. protocol settings**. With a radio receiver for time signals in this case only the digital IOs can be used for the input.
2. Synchronization of several Q.pac Test Controllers through a radio receiver for time signals (without sync line)

Connect the time signal directly on all Test Controllers to the digital IOs (plug terminal 2, connections 9 and 10; refer to Section 4.4.2, page 32). Depending on the output signal, specify **AFNOR via IOs** or **IRIG B003/B005 via IOs** for **Settings > Synchronization > Sync. protocol settings** for all Test Controllers.

3. Synchronization of several Q.gates or Q.pac Test Controllers through SNTP (without sync line)

On all Test Controllers specify **On** for **Host interface > SNTP > SNTP mode** as well as the **Server address** (IP address of the time server).

5.8.3.4

Ring buffers

With Q.gate and Q.pac a ring buffer is available in each case. When reading data from the buffer, all the (new) data are retrieved which are present in the buffer. With the maximum buffer size (16 Mbyte is available) the transfer may take some time. Reduce the buffer if data are retrieved from the buffer only sporadically or not much data is involved.

5.8.4

Storage settings (only Q.pac)

With Q.pac you can set up several data stores, but with active PAC functionality only a maximum of two. For the individual data stores specify the values which are to be recorded in these buffers and with which timing pattern. For example, you can record only every 100th value. The file names are automatically formed from the memory number and date/time.

When a USB stick is inserted, the data written into the data stores are automatically transferred to the stick and, after successful transfer, deleted in the Test Controller.

5.8.5

System variable

IMPORTANT

The system variable created in the default setting for the time or the cycle counter (Cyclecounter) must not be changed.

In the System Variables section specify further time variables if you would like to use time formats other than in the default system time. Context menu for system variables **Add new variable > ABSDATETIME**. After a double click on the variable and a further click on **Formula** you can then select other formats (Fig. 5-13).

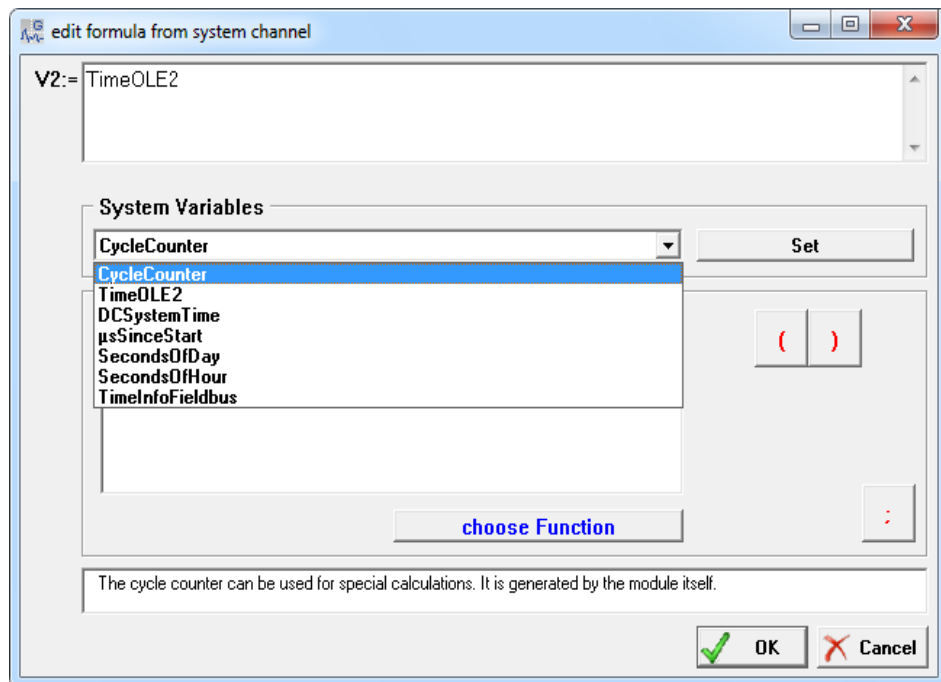

Fig. 5-13 Dialog for specifying the time format.

5.8.6

Virtual variable

With virtual variables you can carry out computations, evaluate trigger conditions or carry out assessments. The variables can be output like measurements or linked to other variables, measurements or digital I/Os.

In the context menu for virtual variables select **Add new variable > ARITHMETIC_EMPTY**. After a double click on the variable you can either specify a formula for the computation, define an event which is to be monitored (trigger) or specify the data format to be used (Fig. 5-14).

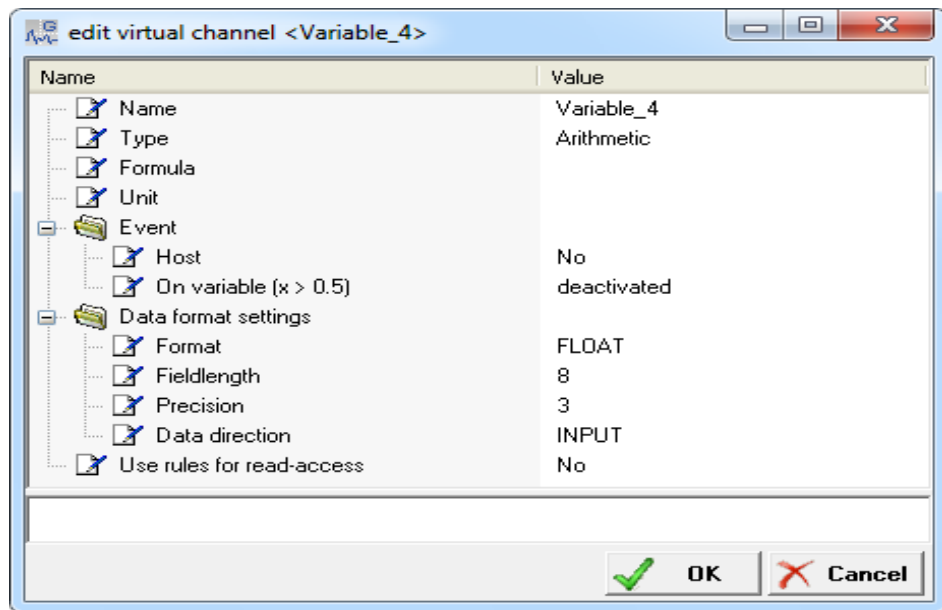

Fig. 5-14 Configuration dialog for a virtual variable.

Click on, for example, **Formula** to enter a computation (Fig. 5-15).

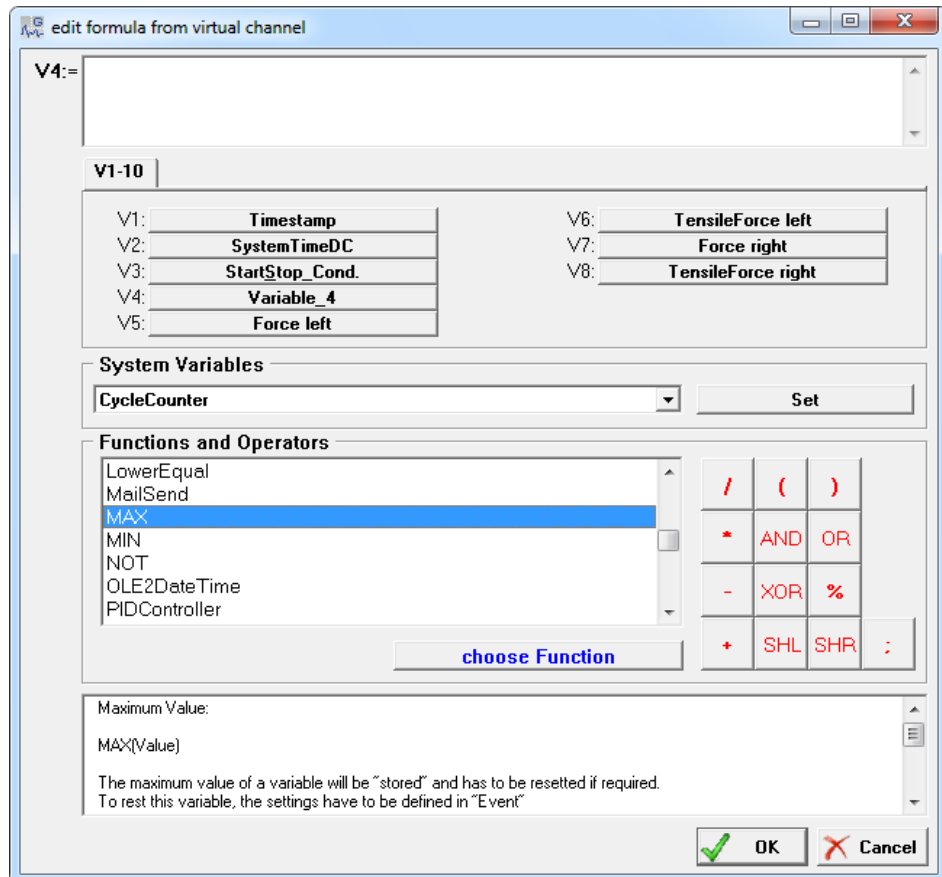



Fig. 5-15 Defining a computation (formula).

In the dialog you have available all variables already defined (tab **V1-10** and other tabs if more than ten variables have been defined). Click on one of the variables to insert it into the formula. Use the field **Functions and operators** to select a mathematical or logical function (select the function and click on **Select function** so that it is accepted into the formula field). Where required add brackets (simply enter them via the keyboard) in order to obtain the correct computational sequence. Close the dialog with OK.

 **IMPORTANT**

Select   or **File > Write project (update)** in the test.com-mander to transfer the new definition into the Test Controller. The project file is in this case automatically updated.

5.9 Online tools

5.9.1 Read data buffer (with measurements)

Click on  or use **File > Read online data buffer from controller** to be able to read out and view all values from the ring buffer.

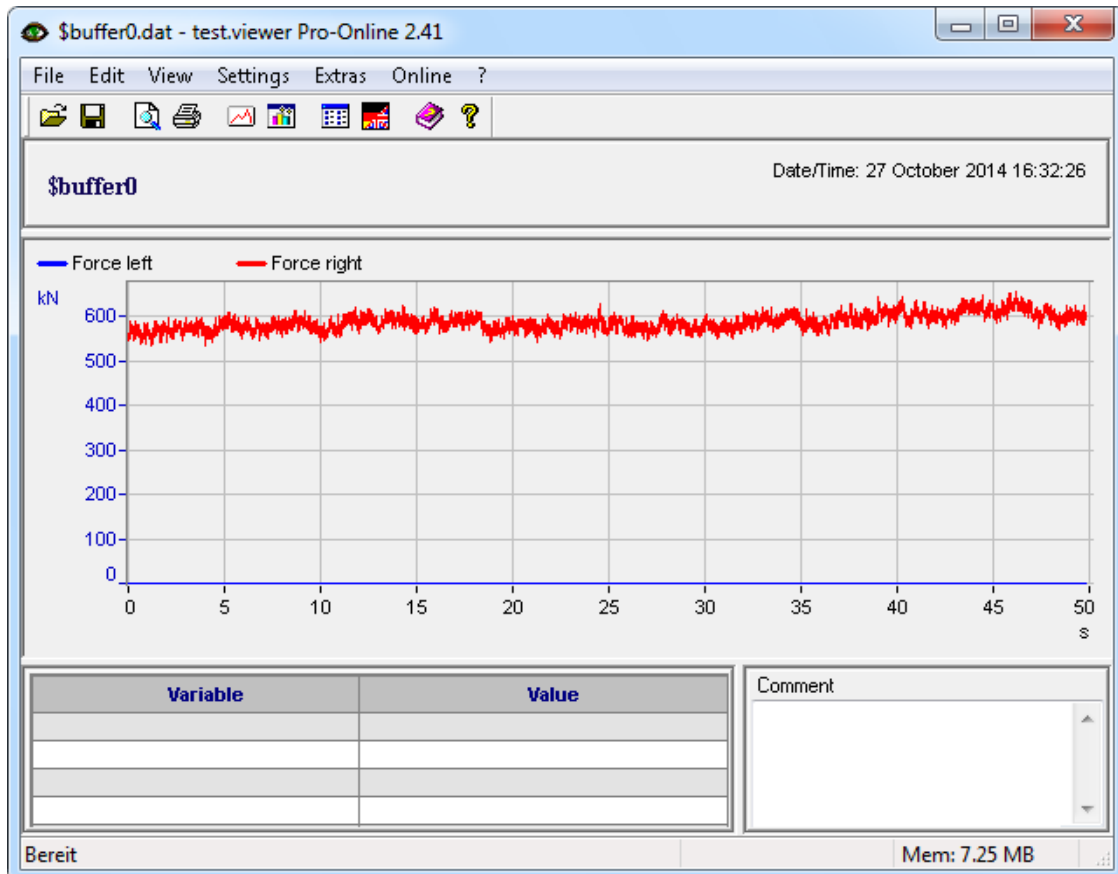



Fig. 5-16 Display of the buffer content with test.viewer.

You can carry out further settings using the menu and symbols, e.g. display the channel list, show the spectra or transfer a live stream of data.

5.9.2 Displaying measurements

Click on  or use **File > Read online values from controller** to be able to view the values of your variables. If you have defined appropriate variables, you can also set initial values in this dialog.

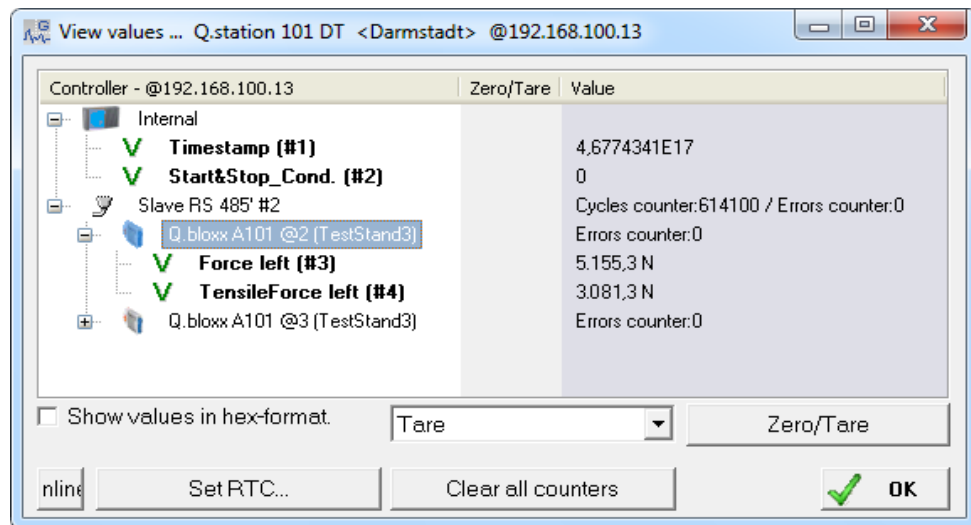



Fig. 5-17 Dialog for displaying the variable values.

In the dialog click on **Show online graphics** to display the values in a graph over time.

5.9.3

Reading module information

Click on  or use **File > Read online module info from controller** to be able to display information such as the address or serial number of your system.

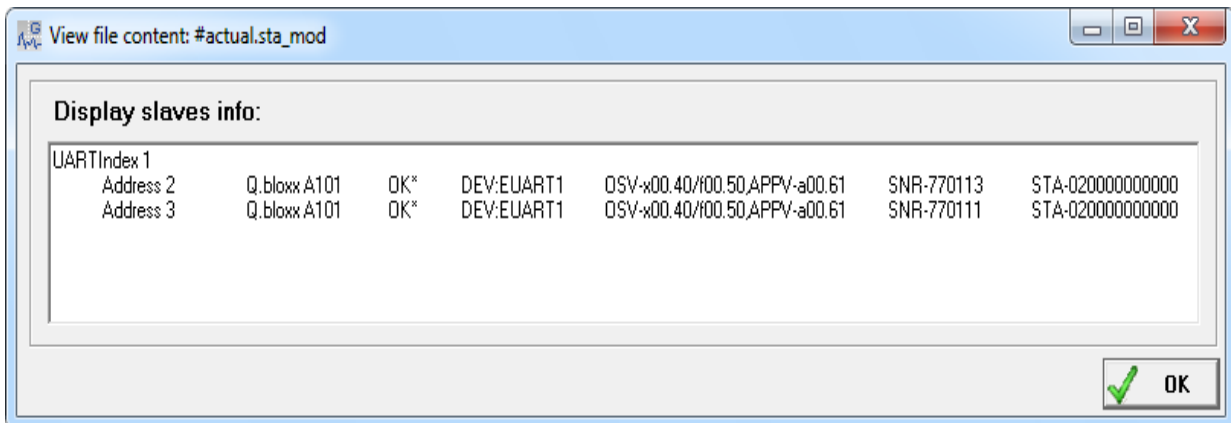



Fig. 5-18 Display of the module information.

5.9.4

Reading status information

Click on  or use **File > Read online status info from controller** to display status information of your system.

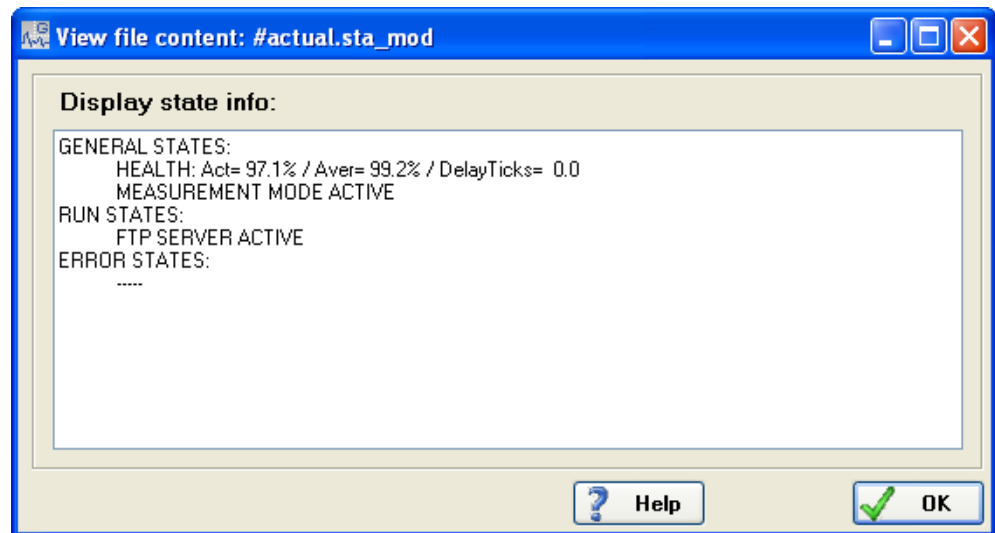

Fig. 5-19 Display of the status information.

5.10 Firmware update

Recently purchased modules or Test Controllers always contain the latest firmware, i.e. the software in the modules or Test Controllers is the current version. However, if you want to combine these modules with older modules and/or Test Controllers, you must update all older modules or Test Controllers and it is essential to update your software to the latest version, because otherwise disturbances in operation due to a communication failure may occur.

The current firmware is in each case included in the latest installations of the programs ICP 100 or test.commander. Here, the program licenses apply to all versions of a program. If required, download the latest versions from our web site: www.gantner-instruments.com. You will find the programs under **Software > Download**.

5.10.1 Firmware update for Test Controller

Install as required the latest version of the test.commander so that you can also install the latest version of the firmware on your PC. Before a new installation is carried out, we recommend that the existing version is uninstalled using the Windows Control Panel.

Procedure

1. In the program test.commander select **Utilities > Controller firmware update**.

The network in the segment of the PC address is searched and the Test Controllers which are found are displayed in the window. If no Test Controller is found, you may have to enter the address manually or set the IP address of your PC to the segment used by the Test Controller; refer also to Section 4.4.3, *Connecting Q.gate/Q.pac via Ethernet to a PC/PLC*, page 34.

2. Mark the Test Controller to be updated and click on **OK**.
The update tool is started and the Test Controllers present in the network are displayed again.
3. Mark the Test Controller to be updated and click on **Update**.
The Windows file dialog is opened and shows you the firmware versions available on your PC.
4. Mark the newest of the available firmware versions (if necessary, switch to the detailed view) and click on **Open**.
The update process is started. Wait until the update has finished. The end of updating is indicated by the dialog "Update completed successfully".
5. Click on **OK** and close the window of the update tool. The firmware update is now completed.

5.10.2

Firmware update for modules

Install as required the latest version of ICP 100 or test.commander so that you can also install the latest version of the firmware on your PC.

Procedure

1. In the program test.commander select **Utilities > Module firmware update**.
2. Make sure that the settings with regard to the interface used are correct: **Options > Communication settings**.
3. Search for the Test Controller or the modules: **Find modules**.
4. If the modules are connected via a Test Controller, in the next window mark the Test Controller to which the modules to be updated are connected and click on **OK**.

6

Functional Procedures

This chapter explains various important settings and processes more comprehensively than in the previous chapters, for example, to provide you with decision-making aids for the interface parameters or the settings of the modules.

6.1

Using serial interfaces

The interface on the Q.bloxx modules is based on the RS-485 standard. This means that data transmissions over distances up to 1 km and the connection of *several* devices to *one* interface is possible; the RS-485 interface is therefore a bus-type interface. With the Q.series up to 16 devices (modules) can be connected per bus segment.

PCs are however usually “only” equipped with one RS-232 interface with which, according to the standard, a maximum line length of 20 m is admissible and only one device can be connected per interface. Therefore for communication with the Q.bloxx modules you need either an RS-485 interface card in the PC or an interface converter.

One technique is particularly important to facilitate large line lengths: the so-called bus termination. This comprises resistances which must be connected in the lines, so that no reflections occur at the line terminations i.e. the resistances attenuate the signal at the end of the line.

You will find further information on these topics and on connection techniques in this section.

6.1.1

Interface converter

Gantner Instruments GmbH offers you two different interface converters:

1. The compact interface converter ISK 200 (bench-top unit)
The converter has an integrated power supply for the connected modules and automatic baud rate detection. The power supply via the 230 V mains, the bus connection and the output voltage of $24V_{DC}$ are electrically isolated from one another.
2. The interface converter ISK 101
The converter is integrated directly into an interface cable. The terminating resistance is also located in the connecting plug and is always active.

You can connect both converters to any “normal” RS-232 interface, e.g. your PC, and then communicate with the Q.bloxx modules (UART connectors) via the RS-485 interface.

6.1.2

Bus termination on the Q.bloxx modules

To avoid signal reflections on the RS-485 interface lines each section (bus segment) must be terminated at its physical start and end with a certain resistance. To achieve this, a terminating resistance is connected between the bus lines A (UART A) and B (UART B). The line A is then connected via a pull-up resistor to the supply voltage potential (Supply +10 to 30V_{DC}) and line B is connected to the Supply 0V through a pull-down resistor. These three resistors ensure an interference-free data transmission and provide defined potentials (voltage levels) when no data is being transmitted over the bus (the interface).

The sockets on the Q.bloxx modules already have these resistors built in. You activate the resistors via the DIP switches 9 and 10; in this way both bus lines are connected to the resistance circuit.

- ➔ If the base is intended for accepting a Q.gate module, the terminating resistances must not be activated, because this module contains its own resistances.

IMPORTANT

The terminating resistances may only be activated at the end points of the interface line (of the bus segment). If resistances are also activated in between, the signal is weakened and interference or even interruption of the data transmission occurs for the modules located after the additional resistances.

6.1.3

Connection technology

With strong ambient interference, as is often found in industrial areas, we recommend screening the bus and signal lines. Generally, you should always wire the screen to the earth conductor/housing and not to the circuit ground. If necessary, the screen can also be connected to the protective earth several times along the cable route for potential equalization. With short distances, e.g. stub lines, better results are often achieved when the screen is only connected to the end of the stub line.

With bus devices such as controllers (PLCs), computers (PCs), repeaters, interface converters, etc. the screen is usually realized by the protective conductor, in some cases using special chassis ground buses. Due to the screen, interference signals are diverted through the protective conductor before they can penetrate into the module. The screen on the bus cable is in this case connected via so-called screen terminals. Similarly, connect the

screen of the transducer line to the terminal with the earth symbol.

6.1.4

Network topologies

For setting up networks various network structures, or so-called topologies, are possible. When connecting the Q.bloxx modules and Test Controller, a simple line or bus structure is required (Fig. 6-1); several "lines" can be brought together by the Test Controller and the UARTs present in the Test Controller (Fig. 6-2). Other topologies, for example the tree structure (Fig. 6-3) used with Ethernet, are not admissible

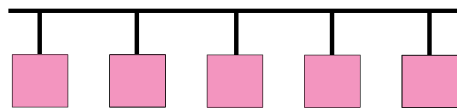

Fig. 6-1 Line or bus structure.

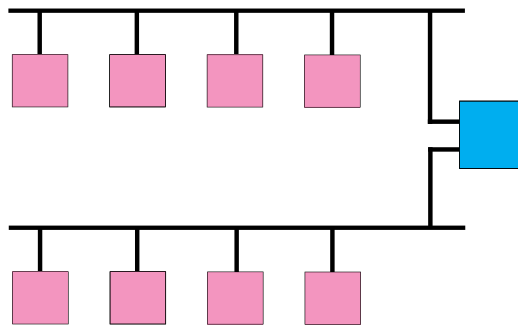

Fig. 6-2 Combination of two lines on the Test Controller.

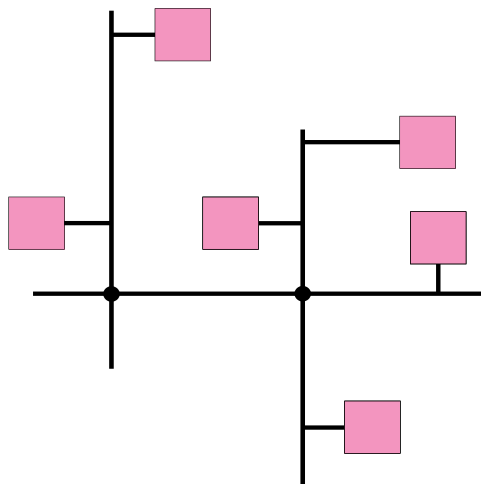



Fig. 6-3 Tree structure.

6.2 Ethernet on the PC

The following sections describe various settings which you can carry out on the PC to enable a link to be formed. The images use menus and dialogs found in Windows 7; the names of the dialogs and fields in other versions of Windows are however similar and are usually also given.

6.2.1 Finding the IP address and subnet mask of the PC

In Windows 7 or 8 open the **Network and Sharing Center**, e.g. using  at the bottom on the right in the taskbar. Click on the **LAN connection** (the name may be different) through which the Test Controller is connected to the PC (Fig. 6-4 on page 139). In the following status dialog (similarly in Fig. 6-4) click on **Details**. The current address is displayed in the next dialog under **IPv4 address**.

The subnet mask determines which addresses can be reached from the PC: Only addresses whose figures are identical in the places which contain a 255 in the subnet mask can be reached. The IP addresses of the PC and Test Controller should normally be located in the same Ethernet segment (only the last group of figures in the IP address is different), otherwise the subnet mask must be 255.255.0.0 so that the last *two* groups of figures may be different.

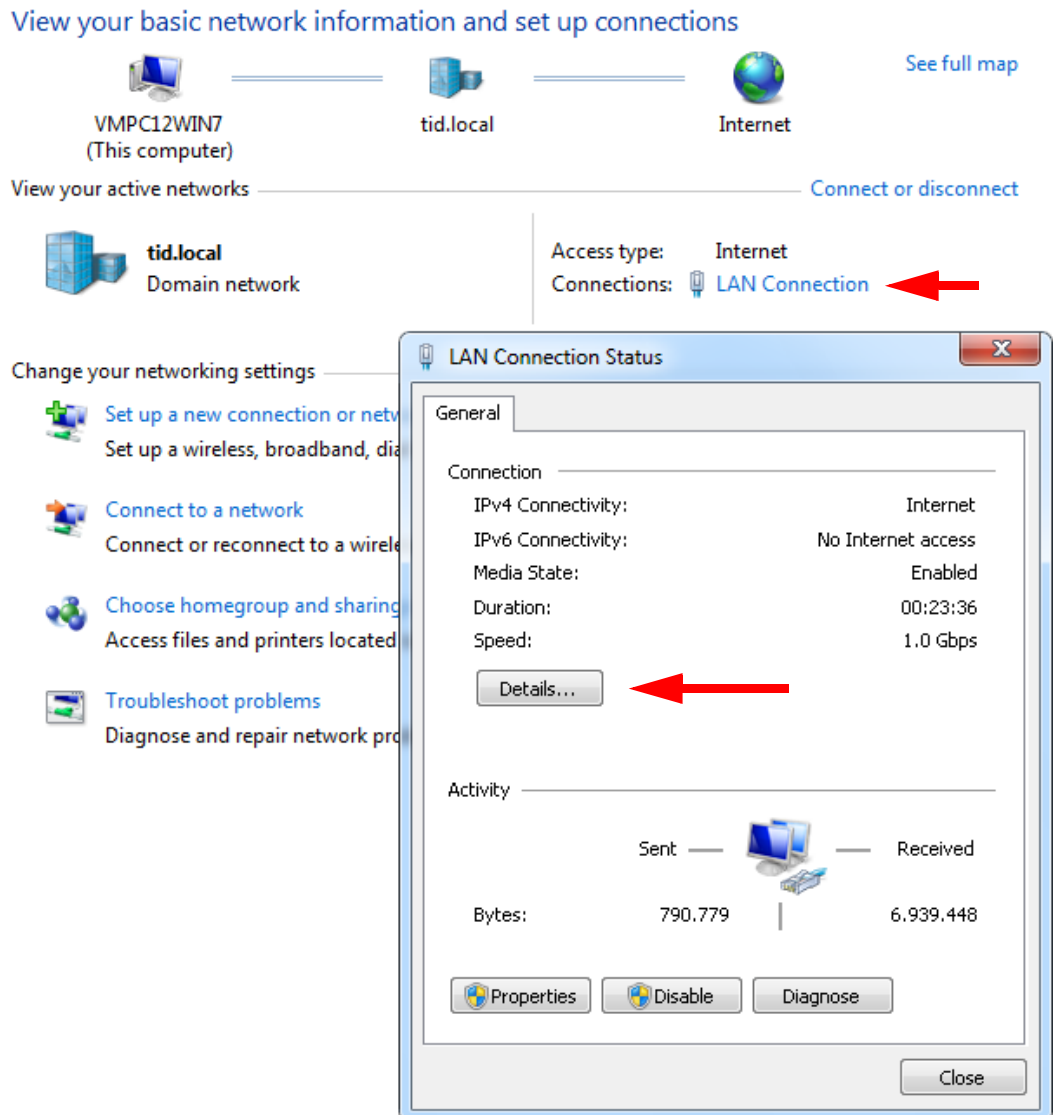

Fig. 6-4 Viewing/changing the IP address of the PC

Example 1

Subnet mask 255.255.255.0, IP address 192.168.100.26

Only addresses can be reached which start with 192.168.100, i.e. the first three groups of figures must be identical and only the fourth may be different.

Example 2

Subnet mask 255.255.0.0, IP address 192.168.100.26

All addresses can be reached which start with 192.168, i.e. the third group of figures may also be different between the PC and Test Controller.

6.2.2

Setting the IP address on the PC

If you want to connect to a Test Controller, you must assign a (temporary) IP address to the PC.

- ➔ We recommend that a temporary IP address is set up on the PC, because then the network settings on your PC for the normal connections are not changed. If you have already set up this type of “alternative configuration” for another network, you must note the existing settings so that you can restore them after concluding the configuration of modules or the Test Controller.

In Windows 7 or 8 open the **Network and Sharing Center**, e.g. using  at the bottom on the right in the taskbar. Click on the **LAN connection** (the name may be different) through which the Test Controller is connected to the PC (refer to Fig. 6-4 on page 139). In the following status dialog click on **Properties** (requires administrator rights). Then mark **Internet Protocol Version 4** and click on **Properties** (refer also to Fig. 6-5).

Then proceed to the register card **Alternative Configuration** and specify an address for the PC, e.g. **192.168.100.5**, and a subnet mask, e.g. **255.255.255.0** (Fig. 6-6).

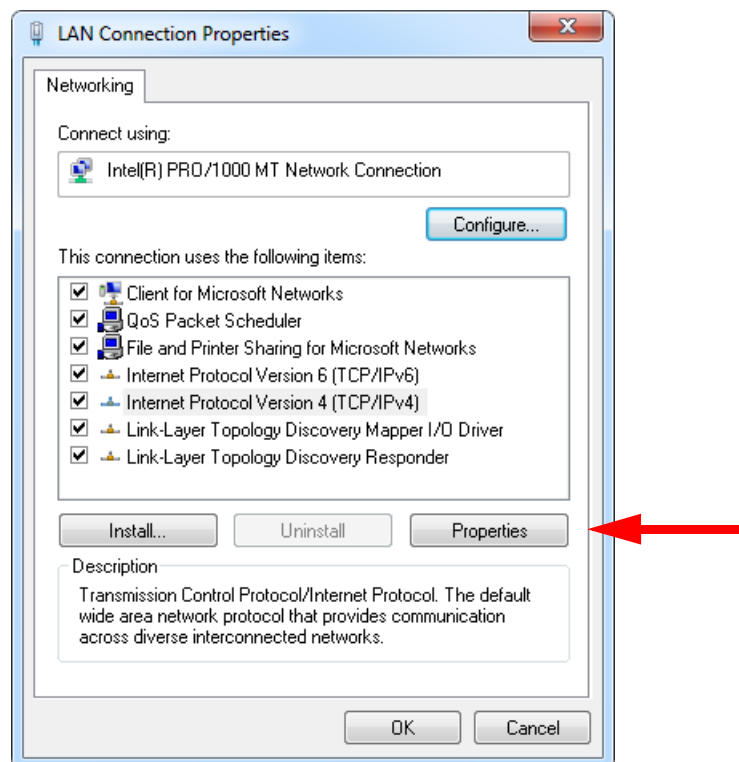

Fig. 6-5 LAN connection properties (Windows 7 and 8)

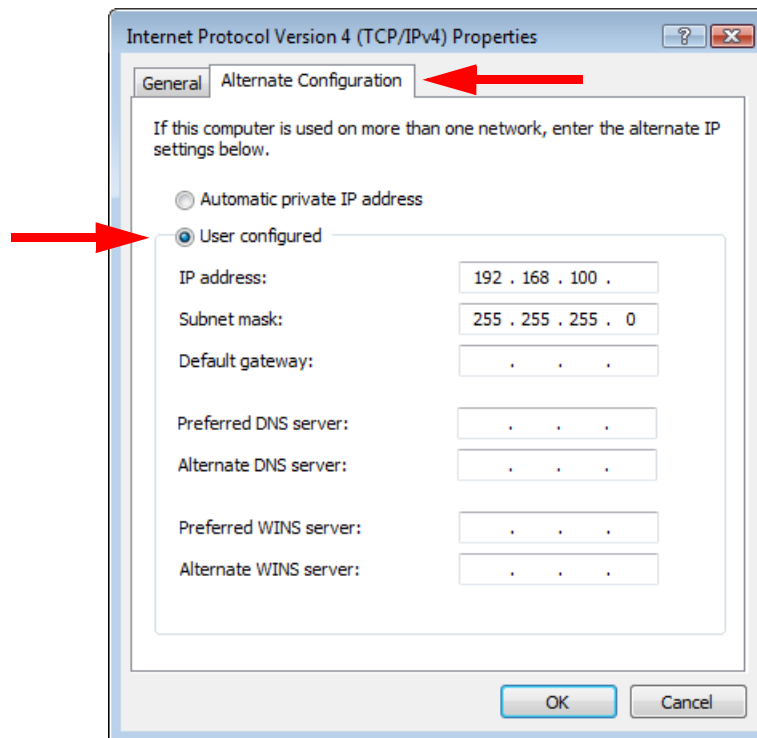

Fig. 6-6 Specifying the IP address and subnet mask for an alternative (temporary) configuration.

6.2.3

Allowing access to network devices (firewall)

Generally, a firewall monitoring access of the PC to the network and vice versa is installed on the PC. Therefore, you must allow access to the Test Controller or the module, otherwise no connection can be established via Ethernet. On the first attempt to establish a connection you receive a message similar to that shown in Fig. 6-7. Click on **Unblock** to allow the connection.

! IMPORTANT

You must possess administrator rights on the PC to be able to unblock the connection. If this is not the case, ask your administrator to do this for you. You must enable all programs for sharing which use an Ethernet connection to the modules or the Test Controllers.

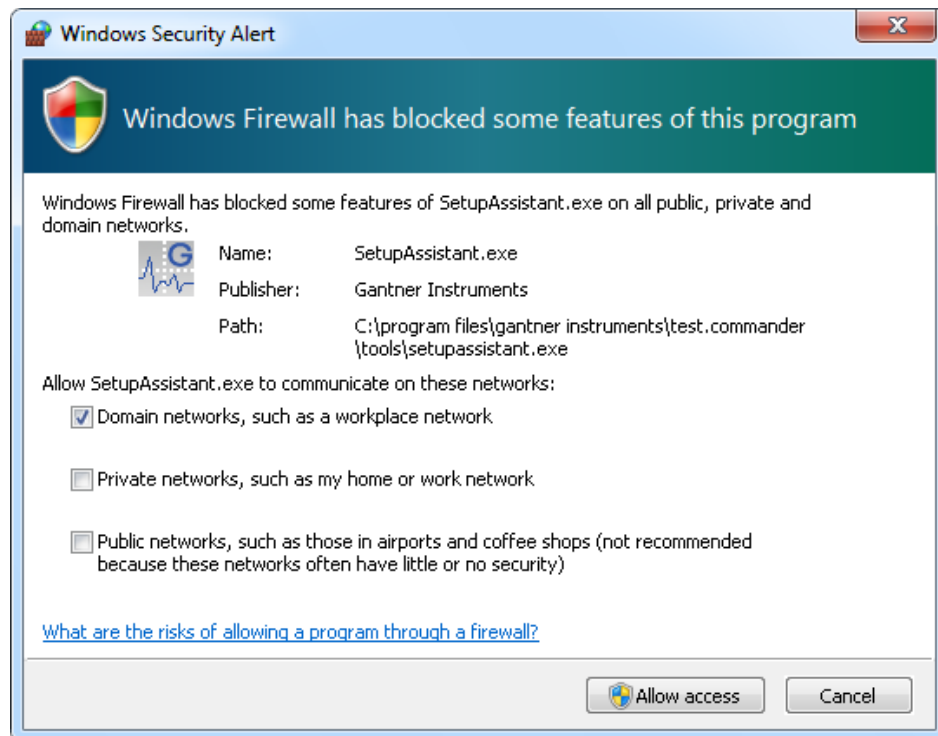

Fig. 6-7 Windows firewall message on attempting to establish an Ethernet connection.

6.3

Connecting sensors with sensing leads

Resistive sensors require an excitation voltage to be able to provide their output signal. For sensor excitation a current is passed through the connecting lead, which however causes a loss of voltage due to the resistance of the connecting lead. Consequently, the sensor is then not supplied with the voltage set on the amplifier module, but rather with a slightly lower voltage. This leads in turn to a lower output signal and, depending on the cable resistance, losses in the single-figure percentage range can occur even with just a few meters. Therefore, high quality amplifier modules for the excitation of resistive sensors use so-called sensing leads which can measure the loss of voltage, since only a very small current flows in them. This is because the inputs for the sensing leads have very high input resistances (usually over $10^6 \Omega$ compared to a sensor resistance of a few 100Ω). The amplifier module can therefore acquire the voltage arriving at the sensor error-free and increase its excitation voltage to compensate for the losses in the connecting cable. This is particularly the case when the temperature of the connecting cable changes. In this case the cable resistance changes and the sensor output signal would therefore also change if no sensing leads were used.

We therefore recommend the use of sensing leads. This is mainly necessary when several meters of cable are used, low measurement deviations are to be obtained or when the temperature of the cable may vary.

6.4 Sensor scaling

Depending on the type of transducer (Sensor type), you have various possible scalings available. With voltage signals and strain gauge bridges (Bridge), you can define a conversion of the measured voltage (volts or mV/V) into a physical unit, e.g. in newtons. With strain gauges a special conversion tool is available to you. Click in the column **Format/balance** of the variables to be set to call up the setup dialog (Fig. 6-8).

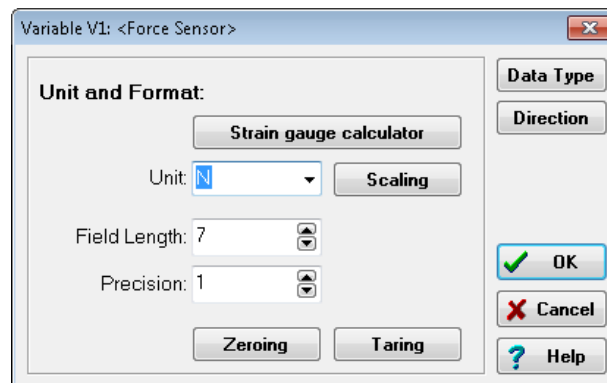

Fig. 6-8 Setup dialog for scaling.

6.4.1 Scaling of voltage signals and strain-gauge bridges

1. In the **Unit** field enter the required physical unit, e.g. **N**.
If the unit has already been entered, you can select it from the list box.
2. Click on **Scaling**.
The scaling dialog is displayed.
3. Enter the transducer (sensor) data from the calibration certificate or from the data sheet (example: refer to Fig. 6-9 on page 145).

Instead of the full scale readings in the positive and negative directions, you can also enter just one direction. Then in each case use **0** for **Measurement** and **Displayed value at Point 1**.

An alternative is the entry of **Factor** and **Offset** if these data have been specified for your sensor.

The numbers in the **Display** field depend on the settings in the **Range/error** column.

4. Close the scaling and setup dialog with **OK**.

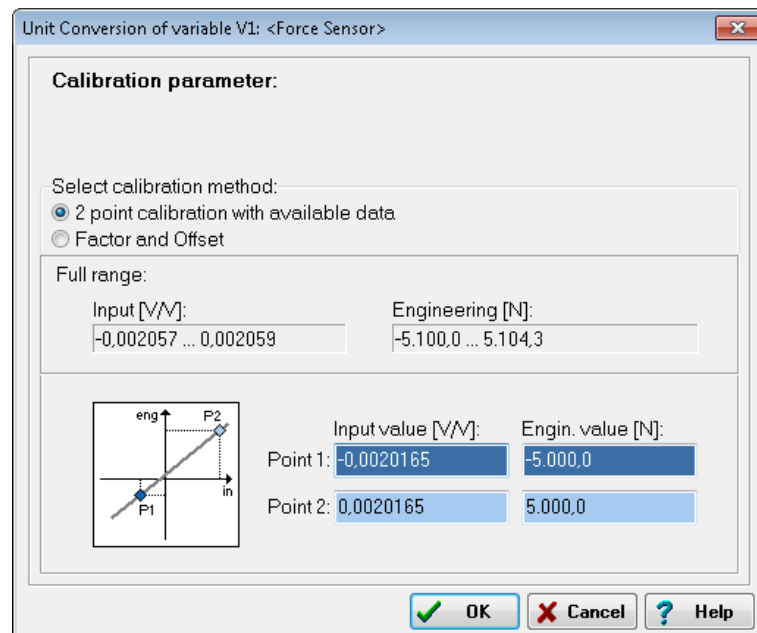

Fig. 6-9 Scaling dialog

6.4.2

Scaling strain gauges

1. Click on **Strain-gauge calculator**, the unit is then automatically changed to $\mu\text{m}/\text{m}$.
2. Enter the gauge factor of your strain gauge in the left field. The gage factor is a measure of the sensitivity of the strain gauge and is stated on each strain-gauge pack. It is usually between 1.8 and 2.2. Fig. 6-10 shows scaling with $k = 2.03$.
3. If you are using more than one active strain gauge in your bridge circuit, you must also state the resulting bridge factor (right field). The factor depends on the orientation of the strain gauge on the measurement object and, where applicable, also on the Poisson's ratio for the material. On a tension/compression bar the bridge factor is, for example, approx. between 2.5 and 2.8 depending on the material.
4. Close the scaling and setup dialog with **OK**.

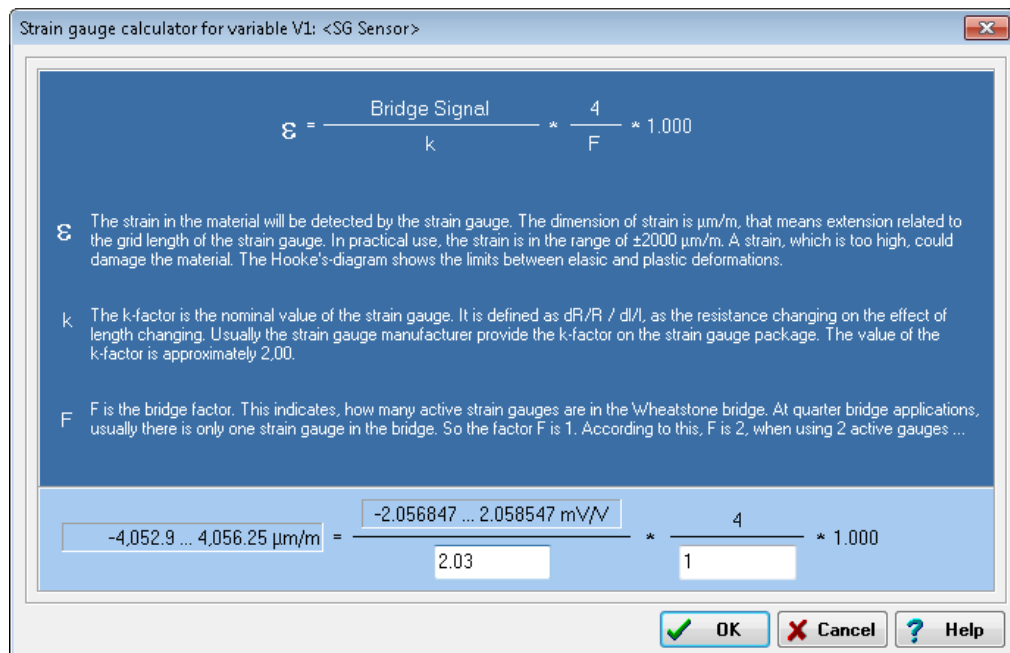

Fig. 6-10 Scaling dialog for strain gauges.

6.5

Current measurement with an external shunt

Current measurements are carried out by measuring the voltage drop across a resistance of known size (shunt resistance). In the Q.bloxx modules, which are suitable for direct current measurement, this is a resistor of 50Ω , with which you can measure currents up to 25mA (the maximum shunt power dissipation is limited to 0.25W). Higher currents need an external shunt which is looped into the line to be measured. The power dissipation occurring at the current to be measured must be lower than the permissible power dissipation of the external shunt. In addition the voltages produced on the resistance must not exceed the permissible input voltage on the analog input of the Q.bloxx module. Configure the analog input as a voltage input and divide the measured voltage by R_{ext} .

! **IMPORTANT**

The error in the current measurement using an external shunt depends on the accuracy of the resistor used.

6.6

Measuring with thermocouples

Thermocouples consist of two “thermoelectric wires” which are formed from different materials, e.g. platinum and platinum/rhodium, and are joined together at one end, usually by welding. If this contact point and the other ends of the thermoelectric cables have different temperatures, a “thermoelectric voltage” is produced at the contact point. This voltage is essentially proportional to the temperature difference between the contact point and the ends of the cables.

Since thermocouples only measure a temperature difference (difference between the temperature at the contact point and the measured temperature at the terminal strip on the Q.bloxx module), the terminal temperature must be known or the “transition” from the thermocouple cable or compensating cable to the copper cable must occur at a known temperature level. The first case is known as internal cold junction compensation (TC_{int}) and the second case as external cold junction compensation, TC_{ext} .

To acquire the temperature with internal cold junction compensation an additional temperature probe is used which measures the reference temperature. For the Q.bloxx modules a cold junction compensation terminal with an integrated Pt1000 temperature probe is used. In this way, the temperature at the “transition point” is determined and the voltage produced by the thermocouple is corrected depending on the type of thermocouple.

To measure the temperature using external cold junction compensation, a second thermocouple of the same type is needed which is connected in series with the first one. The polarity is chosen such that the thermoelectric voltages subtract. The second thermocouple is located at a fixed reference temperature (usually 0°C). Then, the Q.bloxx module calculates the temperature at the measuring point based on the linearization curve. However, the Q.bloxx module requires the information of which reference temperature (cold point temperature) is being used.

7

International Sales and Service

The current addresses of our sales partners can be found in the Internet on our web site. You can take up direct contact with Gantner Instruments GmbH at any time.

You will find further information in the section Technical Information in our Wiki at <https://dev.gantner-instruments.com/doku-wiki>. The user name is **support** and the password is **gins** (not all sections are open to the public).

Austria

Gantner Instruments GmbH
Montafonerstr. 4
6780 Schruns/Austria
Tel.: +43 (0) 5556 77463-0
Fax: +43 (0) 5556 77463-300
E-mail: office@gantner-instruments.com
Web: www.gantner-instruments.com

Germany

Gantner Instruments Test & Measurement GmbH
Heidelberger Landstr. 74
64297 Darmstadt
Tel.: +49 (0) 6151 95136-0
Fax: +49 (0) 6151 95136-26
E-mail: testing@gantner-instruments.com
Web: www.gantner-instruments.com

© 2017 Gantner Instruments GmbH

Vers. No. 6.1
Released: 25/04/2017
Printed: 4/2017

Austria

Gantner Instruments GmbH
Montafonerstr. 4
6780 Schruns
Tel.: +43 (0) 5556 77463-0
Fax: +43 (0) 5556 77463-300
E-Mail: office@gantner-instruments.com
Web: www.gantner-instruments.com

Germany

Gantner Instruments Test & Measurement GmbH
Heidelberger Landstr. 74
64297 Darmstadt
Tel.: +49 (0) 6151 95136-0
Fax: +49 (0) 6151 95136-26
E-Mail: testing@gantner-instruments.com
Web: www.gantner-instruments.com