

Q.series XL MANUAL

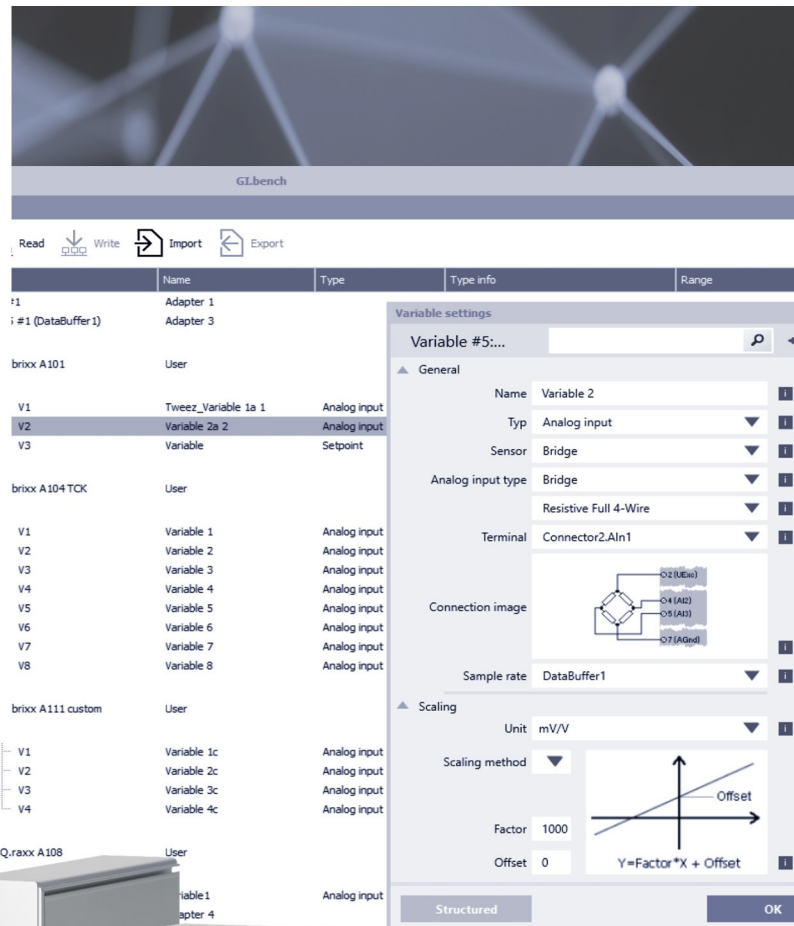

© 2020 Gantner Instruments

Operating instructions, manuals and software are the property of Gantner Instruments and protected by copyright. Copying, duplication, translation, conversion into any electronic medium or machine-readable format in whole or in part is only permitted with the express permission of Gantner Instruments. An exception applies to the production of a backup copy of the software for your use or backup purposes, as far as this is technically possible and recommended by Gantner Instruments. Infringements will be prosecuted to the full extent of the law and will require compensation.

All trademarks and brands used in this document refer only to the particular product, owner of the trademark, or the trademark itself. The naming of products that are not the property of Gantner Instruments is solely for informational purposes. Gantner Instruments does not claim any rights to products other than their trademarks or brands.

Table of Contents

1	Safety Information	9
1.1	Intended Use.....	9
1.2	Checking for Damage in Transit.....	9
1.3	Personnel	10
1.4	Special Risks	10
1.5	Installation Environment.....	10
1.6	Modifications.....	11
1.7	Servicing and Cleaning	11
1.8	Disposal.....	11
1.9	General Hazards due to Improper Operation	12
2	Warnings and Labels.....	13
2.1	Warnings	13
2.2	Labels on Modules	13
2.3	Labels in this Manual.....	14
3	Introduction	15
3.1	Documentation for Q.series XL.....	16
3.2	About this Manual.....	16
3.3	System Description	17
3.3.1	Operating Q.series XL with Q.station X.....	18
3.3.2	Operating Q.series XL without Test Controller	20
3.3.3	Available Q.series XL Form Factors.....	21
4	Q.station X (B/T) Interfaces	23
4.1	Mounting and Connecting the Q.station X (B/T).....	23
4.2	Pin Assignments for Q.station X (B/T).....	23
4.2.1	Pin Assignments for Standard Q.station X (B/T)	23
4.2.2	Pin Assignments for Standard Features (All Versions).....	24
4.2.3	Extended Versions of the Q.station X Test Controller	26
4.3	Communication and Storage Interfaces	29
4.3.1	Ethernet Port.....	29
4.3.2	USB 2.0 Ports	29
4.3.3	SD card Port (Internal Only).....	30
4.4	Q.series XL LED Flash Sequences	31
4.4.1	LED Codes for Q.station X (B/T) Test Controllers	31
4.4.2	LED Codes for Q.series XL Measurement Modules.....	32
4.5	Operating Q.station X via DisplayPort or VNC.....	34
4.5.1	Q.station XB - PN / EC / SSD-1TB (“non T-versions”)	34
4.5.2	Q.station XT - PN / EC / SSD-1TB (“T-versions”)	35

5	System Assembly & Setup	37
5.1	Mounting Q.bloxx X Systems	37
5.2	The Q.series X Socket	37
5.2.1	Configure Operating Mode	38
5.2.2	The Hot-swap Feature.....	40
5.2.3	Configure Module Addresses via DIP Switch (Optional)	41
5.2.4	Activating Terminating Resistances in Modules	42
5.2.5	Mounting and Removing Q.bloxx X Sockets	43
5.2.6	Q.bloxx X Extension Socket (QXES) (QXES) (Left / Right) ..	44
5.3	Connecting a Power Supply to Q.series XL.....	47
5.4	Inserting and Removing Modules from Sockets	48
5.5	Q.series XL Modules and Connection Details	50
5.5.1	Connecting Q.station Classic and Q.series XL Modules	50
5.5.2	Q.series and Q.series XL Sample Rate Limitations.....	50
5.5.3	Overview of Q.series XL Measurement Modules	51
5.6	Q.series XL A101: Connecting Sensors and I/O.....	53
5.6.1	Voltage	53
5.6.2	Current	54
5.6.3	Potentiometer	54
5.6.4	Resistance, Pt100, Pt1000	55
5.6.5	Thermocouple	55
5.6.6	Full and Half-bridge Transducer.....	56
5.6.7	Quarter-bridge Strain Gage	56
5.6.8	IEPE/ICP®	57
5.6.9	Digital Input and Output.....	57
5.7	Q.series XL A102: Connecting Sensors and I/O.....	58
5.7.1	Voltage	58
5.7.2	Current	59
5.7.3	Full and Half-bridge Transducer.....	59
5.7.4	Quarter-bridge Strain Gage	60
5.7.5	IEPE/ICP®	60
5.7.6	Analog Output.....	61
5.7.7	Digital Input and Output.....	61
5.8	Q.series XL A103: Connecting Sensors and I/O.....	62
5.8.1	Voltage	62
5.8.2	Current	63
5.8.3	Digital Input and Output.....	63
5.9	Q.series XL A104 TCK: Connecting sensors	64
5.9.1	Voltage	64
5.9.2	Thermocouple	65
5.10	Q.series XL A105: Connecting Sensors	66
5.10.1	Resistance, Pt100, Pt1000	66
5.11	Q.series XL A106: Connecting Sensors and I/O.....	68
5.11.1	Full and Half-bridge Transducer	68
5.11.2	Quarter-bridge Strain Gage	69

5.11.3	Inductive Full and Half-bridge Transducer	70
5.11.4	LVDT, RVDT	70
5.11.5	Analog Output	71
5.11.6	Digital Input and Output	71
5.12	Q.series XL A107: Connecting Sensors.....	72
5.12.1	Voltage.....	72
5.12.2	Current	73
5.12.3	Potentiometer	73
5.12.4	Resistance, Pt100, Pt1000.....	73
5.12.5	Thermocouple	74
5.12.6	Full-bridge Transducer.....	75
5.12.7	Half and Quarter-bridge Strain Gage	75
5.13	Q.series XL A108: Connecting Sensors and I/O.....	77
5.13.1	Voltage.....	77
5.13.2	Current	78
5.13.3	Digital Input and Output	78
5.14	Q.series XL A109: Connecting I/O and Outputs.....	79
5.14.1	Digital Input and Output, Terminal 1 Only.....	79
5.14.2	Analog Output, Terminal 2 Only	80
5.15	Q.series XL A111 BNC: Connect Sensors	81
5.15.1	Voltage.....	81
5.15.2	IEPE/ICP®	82
5.16	Q.series XL A116: Connecting Sensors.....	83
5.16.1	Full and Half-bridge Transducer	86
5.16.2	Quarter-bridge Strain Gage.....	88
5.16.3	Activating the Shunt Resistance.....	90
5.17	Q.series XL A121: Connecting Sensors.....	93
5.17.1	Voltage.....	93
5.17.2	Current	94
5.17.3	Potentiometer	94
5.17.4	Resistance, Pt100, Pt1000.....	94
5.17.5	Full and Half-bridge Transducer	95
5.17.6	IEPE/ICP®	95
5.18	Q.series XL A123: Connecting Sensors.....	96
5.18.1	Voltage.....	97
5.19	Q.series XL A124: Connecting Sensors.....	98
5.19.1	Voltage.....	99
5.19.2	Thermocouple	99
5.20	Q.series XL A127: Connecting Sensors.....	100
5.20.1	Voltage.....	101
5.20.2	Current	101
5.21	Q.series XL A128: Connecting sensors	103
5.21.1	Voltage.....	104
5.22	Q.series XL A141 BNC: Connect Sensors	105
5.22.1	Piezoelectric, Charge	105

5.23	Q.series XL A146: Connecting Sensors	106
5.23.1	Quarter-bridge Strain Gage	109
5.24	Q.series XL D101: Connecting I/O	112
5.24.1	Digital Input and Output.....	112
5.25	Q.series XL D104: Connecting Digital Inputs	114
5.25.1	Digital Input.....	114
5.26	Q.series XL D105: Connecting Digital Outputs	115
5.26.1	Digital Output	115
5.27	Q.series XL D107: Connecting Digital Inputs	116
5.27.1	Digital Input.....	116
6	Connect Q.station X to a PC	119
6.1	Connect to an Ethernet network via DHCP	119
6.2	Connect to an Ethernet network via Static IP	119
6.3	GI.bench: Configuration Software	120
6.3.1	Creating Projects in GI.bench.....	121
6.4	Establish a Connection	124
6.5	Synchronization of Q.station X Test Controller.....	125
6.5.1	Connecting Radio Receivers for Time Signals.....	128
6.5.2	Connect a GPS Receiver	128
6.6	Installing GI.bench.....	131
6.7	Ethernet on the PC	132
6.7.1	Determine the IP address and subnet mask of the PC	132
6.7.2	Set the IP address of the PC	133
6.7.3	Allow Access to the Network (Windows Firewall)	135
7	Configure the Q.station X	137
7.1	Basic Settings in GI.bench.....	138
7.1.1	Controller Settings	138
7.1.2	Adapter Settings: UARTs (RS485 #1 to #4), CAN #1	142
7.1.3	Host Interfaces	145
7.1.4	USB devices (GPS, Modbus-RTU, CAN)	150
7.1.5	Sample Rate and Logger Settings	151
7.2	System (Time) Variables	152
7.3	Configuring Digital Inputs of Q.station X	153
7.3.1	Digital Inputs	153
7.4	Virtual Variables	156
7.4.1	Defining Virtual Variables.....	156
7.4.2	Defining CAN Signals	158
7.4.3	Creating Logger Status Variables.....	159
7.4.4	Configuring Modbus RTU Signals	162
7.5	Firmware update	164
7.5.1	Firmware Updates for Q.station X.....	164

8	Configure the Modules	165
8.1	Configuring Analog Inputs	166
8.1.1	Sensor Parameters in GI.bench	166
8.1.2	Carrier Frequency Synchronization (Q.series XL A106)	169
8.1.3	Zeroing and Taring Sensor Measurements	169
8.2	Defining Digital Inputs and Outputs	172
8.3	Configuring Analog Outputs	174
8.4	Defining Computations (Virtual Variables)	176
8.5	Configuring Alarm Monitoring.....	178
9	Record Data with Loggers.....	181
9.1	Configure Sampling Rates and Data Buffers	182
9.1.1	Sample Rate Settings	184
9.2	Assign Sample Rates to Variables	187
9.3	System (Data) Streams	188
9.3.1	Stream Processor Settings	188
9.4	Data Logger Configuration	189
9.4.1	Data Logger Settings.....	190
9.4.2	Available Variables	192
9.4.3	Data Logger Settings Continued	192
9.4.4	Enhanced Settings.....	197
9.4.5	Trigger and Event Settings	198
10	Access Data on Q.station X	201
10.1	Access Data via SMB/CIFS	201
10.1.1	Using Windows Explorer to Connect to Q.station X.....	201
10.1.2	Mapping the Q.station X as a Network Drive	204
10.2	Remote Control Q.station X via VNC	206
10.3	Remote Control Q.station X via Web Server	209
11	Functional Procedures.....	211
11.1	Using Serial Interfaces	211
11.1.1	Interface Converters	211
11.1.2	Connection Technology	212
11.1.3	Network Topologies	212
11.2	Connecting Transducers with Sensing Leads	214
11.3	Sensor Scaling in GI.bench.....	215
11.3.1	Scaling Voltage Signals and Strain Gage Bridges	216
11.3.2	Scaling with Strain Gage Calculator	217
11.4	Available Units in GI.bench.....	219
11.5	Current Measurements with External Shunt.....	221
11.6	Measurements with Thermocouples	222
12	Sales & Service Information	223

1

Safety Information

Before performing any installation, operation or maintenance processes, it is essential to carefully read and understand the appropriate warning and safety information provided in this manual. Please perform these tasks as intended (i.e., as directed in this manual and the technical data sheets for the relevant modules or devices). Failure to do so may result in damage to the connected modules or devices. If you require any technical support, please contact Gantner Instruments or your domestic Gantner Instruments Sales and Service location.

1.1

Intended Use

Q.series XL products are intended for use in test engineering (experimental and industrial) as well as process monitoring (production and assembly) applications. Transducers (sensors) can be connected to Q.series XL products for the control, acquisition, manipulation, and storage of physical quantities such as voltage, current, resistance, temperature, force, displacement, torque, mass, strain, and pressure (data). Q.series XL products, especially the measurement modules, are intended to be used exclusively for these purposes. Any application that extends beyond the scope as mentioned above does not fall within the intended use of Q.series XL products.

To ensure safe operation, carefully select the appropriate Q.series XL product(s) for each application (i.e., select modules for purposes that align with their respective intended use). Additional details regarding each Q.series XL product and their intended uses are available in this manual as well as in each Q.series XL product's respective technical data sheet.

Always carefully follow all necessary legal and safety guidelines pertinent to your application. This applies especially to any application in which the Q.series XL A121, A123, A124, A127, or A128 modules are utilized as they for voltage inputs of up to $1200V_{DC}$.

1.2

Checking for Damage in Transit

Upon receipt of goods, visually confirm that the packaging and all included items are intact and not damaged. Please also confirm the completeness of the order shipment (i.e., all expected accessory parts, documentation, and auxiliary aids are included). If you suspect the packaging or any included items have been damaged in transit, do not put them into operation. Contact Gantner Instruments or your domestic Gantner Instruments Sales and Service location immediately for further instruction.

1.3

Personnel

The installation, operation, and maintenance of Q.series XL products should only be performed by appropriately trained personnel. Such individuals should possess the necessary professional education, experience within their respective field and be aware of all applicable national occupational safety regulations and engineering practices.

Personnel assigned to the operation of Q.series XL products must be able to reliably assess the results of their work, be familiar with the contents of this manual as well as be aware of all support options available to them. As always, electrical connections should only be performed by specialist personnel with sufficient training and certifications.

In particular, please pay attention to the following while referencing this manual:

- national installation regulations
- generally accepted engineering rules and methods
- information regarding transport, installation, operation, maintenance, repair and disposal of Q.series XL products
- the characteristic functionality, parameter limits and intended operating and ambient conditions of Q.series XL products.

1.4

Special Risks

The A121, A123, A124, A127, and A128 modules are specially designed for high voltage measurements. Up to 1200V can be applied to these modules. Touching the sensor connection contacts or any exposed wires in the connected sensor cables can result in serious bodily injury or even death. Therefore, it is crucial that only qualified personnel have access to these modules and that they ensure the modules have been de-energized via a power switch or similar device before maintenance is performed.

1.5

Installation Environment

Please note the permissible ambient conditions for each Q.series XL product specified in this manual or in their respective technical data sheet. If you have questions regarding any Gantner product, please contact Gantner Instruments or your domestic Gantner Instruments Sales and Service location for information.

If you suspect the ambient conditions of an installation site would require additional protection for a Q.series XL system, consider installing the Q.series XL system in a waterproof enclosure.

1.6

Modifications

Gantner Instruments does not permit the modification or disassembly of Q.series XL products, except as expressly stated within this manual. Protective housings of Q.series XL modules or devices may only be removed for calibration or technical service purposes by Gantner Instruments. If you have questions regarding permissible modifications for Q.series XL products, please contact Gantner Instruments or your local Gantner Instruments Sales and Service location for more information.

1.7

Servicing and Cleaning

Q.series XL products are designed to be maintenance-free. However, if it is required, cleaning should only be performed when Q.series XL modules and devices are in a de-energized state. Please follow the instructions below if you would like to clean your Q.series XL modules or devices:

- Power down and de-energize all Q.series XL modules and devices
- Remove all electrical connections to Q.series XL modules and devices before cleaning
- Clean the housing of Q.series XL modules and devices with a soft, slightly damp cloth (e.g. microfiber). Do not use solvents of any kind when cleaning as they can damage the housing
- When cleaning with a slightly damp cloth, ensure that no liquid gets into the housing or any electrical connections

Never attempt to repair a Q.series XL module or device if you detect defects, faults or damage of any kind. If you detect any of these, contact Gantner Instruments or your domestic Gantner Instruments Sales and Service location for assistance.

1.8



Disposal

For the disposal of old or no longer functional Q.series XL products, please follow all applicable national and local environmental protection and raw material recovery regulations for the disposal of electronic devices and components. Electronic components of any kind should never be disposed of with regular waste. The aluminum housing of Q.series XL products is recyclable.

Gantner Instruments recommends the original packaging of each Q.series XL product is kept until the end of their warranty period for proper storage and shipping of additional or faulty Q.series XL products, respectively.

1.9

General Hazards due to Improper Operation

All Q.series XL products are designed for reliability, stability, and safe operation. However, improper operation of Q.series XL products by untrained personnel may introduce hazards that could otherwise be avoided.

The installation, operation, and maintenance of Q.series XL products should only be performed by appropriately trained personnel who are familiar with the contents of this manual and aware of all the support options available to them.

Should you have any questions regarding recommended methods for installation, operation, and maintenance of Q.series XL products, contact Gantner Instruments or your domestic Gantner Instruments Sales and Service location for information.

2

Warnings and Labels

2.1

Warnings

To prevent personal injury and damage to property, follow the warning and safety information given in this operating manual.



Indicates a directly threatening hazard. If it is not prevented, the consequence will be fatal or serious injuries.



Indicates a possibly hazardous situation. If it is not prevented, the consequence may be fatal or serious injuries.



Indicates a possibly hazardous situation. If it is not prevented, the consequence may be injuries of slight or medium severity.

NOTICE

Indicates a situation in which the consequence may be property damage if the information is not followed.

2.2

Labels on Modules

Symbol: 

Meaning: This is the official CE mark. With this mark, we guarantee that our products meet the requirements of the relevant EC directives.

Symbol: **CAT I, CAT II, CAT III**

Meaning: Modules with a measurement category symbol are intended for the connection of high voltage. The maximum permissible voltage of such modules is indicated by the measurement category rating it is assigned.

Symbol: 

Meaning: There may be high voltage at the terminals of this module. Connections may only be performed with the insulated terminals provided by Gantner Instruments.

2.3

Labels in this Manual

This manual utilizes the following labels and notation in addition to the warnings listed above:

IMPORTANT

Paragraphs with this label give important information relevant to the topic or product discussed in that section.

Tip

Paragraphs with this label provide tips and other particularly useful information relevant to the topic discussed in that section.

Symbol: 

Meaning: Before connecting or disconnecting, make sure that all electrical lines are de-energized.

<i>italics</i>	indicates importance or the name of an official Gantner Instruments software tool or feature
interface	indicates necessary user input: target menu items or clicks; target entry fields in interfaces
Options	indicates menu items (sequence), program interfaces (general or non-target)
>	notation that denotes a sequence of menu items (e.g., Options > Settings)
➔	indicates special features, restrictions, and recommendations to the user, i.e. Please Note

3

Introduction

Dear Customer,

Thank you for purchasing your very own Q.series X product(s) developed by Gantner Instruments. We are confident you will be pleased with your purchase of a professional quality product that enables fast, accurate and reliable data acquisition.

We at Gantner Instruments, an international and customer oriented test and measurement technology company, are always interested in knowing your experience while using our products. It is our primary focus and the main driver behind our continuous innovation. Should you discover any technical faults within our products, errors in our support documentation or if you want to provide feedback, please contact your domestic Gantner Instruments Sales and Service location or our corporate headquarters. You can find the contact information for your domestic Gantner Instruments Sales and Service location as well as our corporate headquarters on our website at <https://www.gantner-instruments.com>.

The scope of your delivery also includes this manual. Please keep this manual in a safe place for constant reference. You may download the latest version of this manual from our website. To avoid personal injury and property damage, please review and follow the Safety Information & Warnings and Labels sections in this manual. Should you ever get stuck despite studying this manual, please contact our corporate headquarters or your domestic Gantner Instruments Sales and Service location for information. You can also find additional technical information in the Technical Information section of the Gantner Instruments Wiki at:

<https://dev.gantner-instruments.com/dokuwiki>.

Please use the following login information to gain access.

Username: *support* Password: *gins*

(Note: Not all sections of the wiki are open to the public).

Austria

Gantner Instruments

Montafonerstraße 4

6780 Schruns

Tel.: +43 (0) 5556 77463-0

Fax: +43 (0) 5556 77463-300

E-Mail: office@gantner-instruments.com

Web: www.gantner-instruments.com

3.1 Documentation for Q.series XL

Supporting documentation for Q.series XL products consist of this manual and a technical data sheet at minimum.

This manual contains descriptions of currently available Q.series XL measurement modules and the Q.station X Test Controller. Updated technical data sheets for all Q.series XL products are available for download on the Gantner Instruments website: <https://www.gantner-instruments.com/downloads/>.

3.2 About this Manual

This manual describes the installation, commissioning, and configuration of the Q.station X Test Controller and the Q.series XL measurement modules A101, A102, A103, A104, A105, A106, A107, A108, A109, A111, A116, A121, A123, A124, A127, A128, A141, A146, D101, D104, D105, and D107 using the software package *GI.bench* developed by Gantner Instruments.

Q.series XL measurement modules differentiate from each other via their quantities of analog and digital I/O, maximum possible sample rates, and admissible input signal voltages.

This manual is structured as follows:

- Safety Information is available in Chapter 1, page 9.
- Warnings and Labels visible on Q.series XL products and throughout this manual can be found in Chapter 2, page 13.
- An introductory overview of Q.series XL system functionality and expansion options can be found in Chapter 3, page 15.
- Descriptions of Q.station X functionality, interfaces, and pin assignments can be found in Chapter 4, page 23.
- Descriptions for system assembly and I/O pin assignments for Q.series XL modules can be found in Chapter 5, page 37.
- Descriptions for establishing a connection with a PC, how to synchronize Test Controllers and how to update the firmware for the Q.station X are in Chapter 6, page 119.
- The basic configurations for Q.series XL modules, with use of the program *GI.bench*, that are necessary in order to perform measurements are available in Chapter 8, page 165.
- Descriptions in regards to recording data via integrated data loggers in the Q.station X are seen in Chapter 9, page 181.
- Instructions for remotely accessing data on the Q.station X Test Controller can be found in Chapter 10, page 201.
- A comprehensive explanation of Q.series XL measurement technology, background information on sensors, and operational procedures can be found in Chapter 11, page 211.

3.3

System Description

The Q.station X Test Controller and Q.series XL measurement modules are designed for industrial and experimental testing purposes. Q.series XL products are exceptionally well suited for performing highly synchronized, multi-channel measurements of electrical, mechanical and thermal signals on engine and component test benches as well as long-term process monitoring applications. Depending on the modules used, the individual channels of each module are capable of changing operating modes for the measurement of voltages, thermocouples, resistances, or other sensor types. The Q.series XL A121, A123, A124, A127, and A128 modules are designed specifically for high-voltage conditions.



Voltage inputs of up to 1200V may be connected to Q.series XL A121, A123, A124, A127 and A128 modules.

Before performing service to or with cables or the modules, ensure to *Lockout/Tagout* any connected power supplies.

Q.series XL modules are combined together to form custom DAQ systems as needed. Connect up to 64 Q.series XL measurement modules to a single Q.station X Test Controller. Each module can be assigned an address from a connected PC or programmable logic controller (PLC). Alternatively, individual measurement modules can be addressed directly via the serial interface. For all measurement modules, the power supply, bus interface and I/O (analog and digital) are all electrically isolated from one another. This manual serves to describe the connection and configuration of the Q.series XL measurement modules and the Q.station X Test Controller for basic measurement applications only. For further assistance with the system setup process, contact your domestic Gantner Instruments Sales and Service location.

For tailored assistance with the optional Programmable Automation Controller (PAC) functionality for test automation, configurable via Gantner Instruments' software tool *test.con*, contact your domestic Gantner Instruments Sales and Service location.

- ➔ Download *test.con* (version 6.2.0 or higher for Q.station X) for free on our website at www.gantner-instruments.com.

3.3.1

Operating Q.series XL with Q.station X

Q.station X is available in many variants for use with Q.series XL:

Base Type	Extended Versions	Ext. Version Interface(s)	PAC functionality using <i>test.con</i> HMI Designer
Q.station XB	Q.station XB-PN	PROFINET slave	No
	Q.station XB-EC	EtherCAT	No
Q.station XT	Q.station XT-SSD-1TB	1TB SSD storage	No
	Q.station XT-PN	PROFINET slave	Yes
	Q.station XT-EC	EtherCAT	Yes
	Q.station XT-SSD-1TB	1TB SSD storage	Yes

Features of the Q.station X

The Q.station X Test Controller is a programmable Q.series XL module with a Real-Time Linux OS which can replace the need for a PC during test automation and data collection.

The Q.station X, and all versions of it, include a 1.6GHz Atom Z530 micro controller with 1GB of RAM and 4GB internal flash memory for internal data storage via any of 20 included loggers.

The Q.station X can be configured for a wide range of functions and applications. **T-version** Q.station X Test Controllers offer a fully programmable graphical Human Machine Interface (HMI) visible via DisplayPort or VNC. Also included in **T-version** Test Controllers is PAC functionality configurable via *test.con*, a tool that allows graphical programming of application-specific functionalities, which run on the edge in real-time. See Section 4.5.2, page 35 for more information regarding **T-version** Q.station X Test Controllers.

- ➔ Download *test.con* (version 6.2.0 or higher for Q.station X) for free on our website at www.gantner-instruments.com. For more instructional material related to *test.con*, visit <http://testcon.info>.

For additional information regarding the optional Programmable Automation Controller (PAC) functionality for test automation, configurable via the software *test.con*, contact your domestic Gantner Instruments Sales and Service location for assistance.

IMPORTANT

The Q.station XB and its variants offer a standard graphical Human Machine Interface (HMI) visible via DisplayPort or VNC, however, PAC functionality via *test.con* is *only* possible for Q.station XT and its variants, i.e., XT-PN, XT-EC, XT-SSD-1TB.

The Q.station X is equipped with 1 GB/s Ethernet, two USB 2.0 interfaces, six digital inputs, four RS-485 slave interfaces, a fifth RS-485 interface (UART) for configuration purposes, a CAN port, a controller Sync port, and a web server as standard features. Standard supported external synchronization protocols include Precision Timing Protocol (PTPv2), IRIG-B, and GPS.

Q.station X can be extended to include additional interfaces, i.e., PROFINET slave (PN), EtherCAT (EC), or additional storage (SSD-1TB); more versions COMING SOON.

You can connect up to 16 Q.series XL measurement modules to each of the four RS-485 serial slave interfaces or UARTs of the Q.station X Test Controller (see example in Fig. 3-1, page 19).

- ➔ Actual system network topologies can vary greatly. Please refer to Section 11.1.3, *Network Topologies*, page 212 for examples and details regarding each system structure.

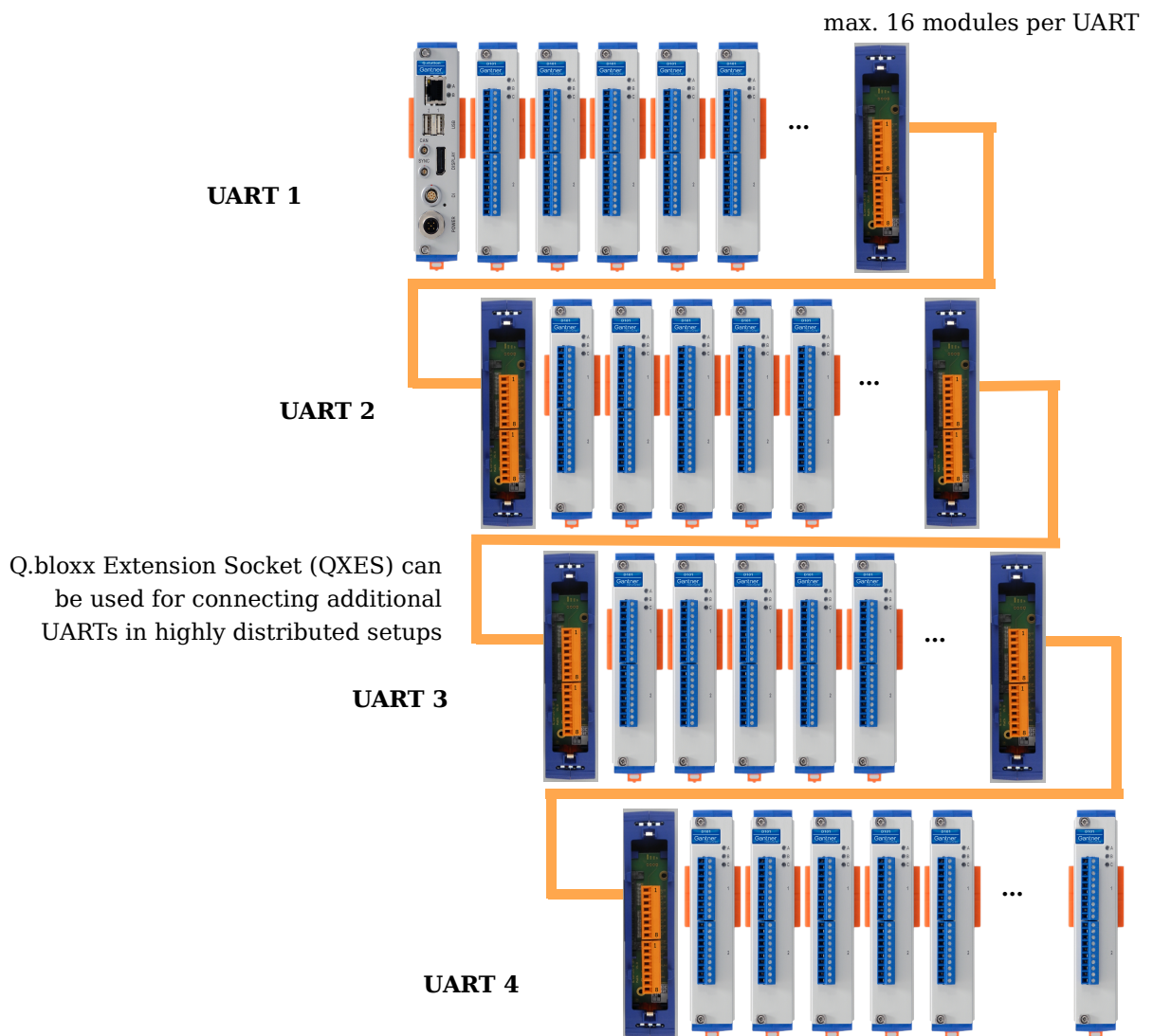

Fig. 3-1 Q.station XB with 64 Q.bloxx XL measurement modules; Network Topologies available in Section 11.1.3, page 212

Q.series X modules connected in series with UARTs selected via CPU DIP switches

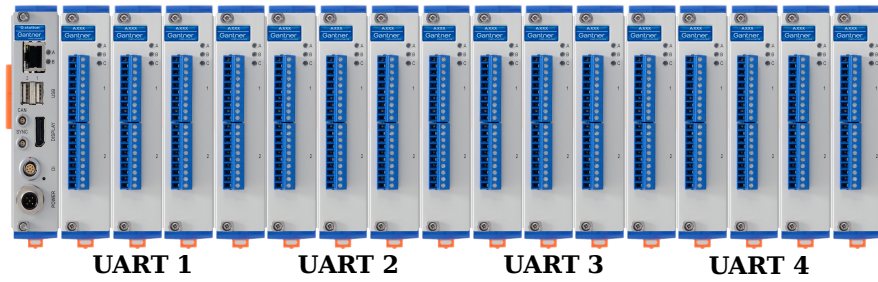

Fig. 3-2 Q.station XB with 4 UARTS of Q.bloxx XL measurement modules connected in series

Data Throughput at 48Mbaud w/ Sample Rate 10kHz w/ Sample Rate 100kHz	32 channels per UART; 128 channels total 4 channels per UART; 16 channels total
Ethernet Data Throughput (transmission rate w/ block transfer)	512 variables (10kHz) 32 variables (100kHz)
EtherCAT Data Throughput (transmission rate)	Read 253 values and write 253 values (at 10kHz, cycle time ≥ 100µs)
Standard Interfaces (Included in all Versions)	Ethernet, 5x UART, CAN port, Sync port, 6x digital inputs, 2x USB 2.0 up to 4Mbyte/s
Extended Interfaces (XPN/2 or XTPN/2 versions)	PROFINET slave or Q.boost A101 interface
Max. Quantity of Slaves (Q.series XL modules)	64 modules; max. 16 modules per UART

3.3.2

Operating Q.series XL without Test Controller

You can connect individual Q.series XL modules directly to a PC or to a PLC via the RS-485 interface on the modules. For this to be possible, you will need a Q.bloxx X Extension Socket (QXES) (Left / Right), see Section 5.2.6, page 44 for more information.

This is best performed utilizing Serial Converters offered by Gantner Instruments, refer to Section 11.1.1, *Interface Converters*, page 211.

The following RS-485 protocols are available:

- Gantner's proprietary fast binary protocol. Configuration using this method takes place via the program *GI.bench*.
- ASCII for reading and writing variables or values using simple commands. Module configuration via ASCII is *not possible*.

For additional information regarding available serial interfaces, refer to Section 11.1, *Using Serial Interfaces*, page 211.

3.3.3

Available Q.series XL Form Factors

Q.series XL products can be packaged in various form factors to best accommodate the specific needs of an application. In addition, Q.series XL products can be interchanged between various form factors to allow for future adaptations. The following are the available form factors for Q.series XL:

- Q.bloxx XL is ideal for widely distributed installations that require higher performance and custom sensor terminations. Q.bloxx XL products are packaged in modular, DIN Rail mountable enclosures that easily snap together for system expansion. Flexibility in distribution allows for highly synchronized data that is less prone to noise due to shorter sensor cable runs to the subject.
- Q.brixx XL is ideal for on-the-go applications requiring higher performance in potentially harsh environments. Q.brixx XL DAQ systems consist of up to 16 measurement modules and an integrated, high-performance controller for communication, control, and data logging purposes, all within a robust aluminum housing capable of withstanding severe shock and vibration without sacrificing performance.
- Q.raxx XL is a 19" rack-mount solution ideal for applications that require high channel density and custom sensor terminations. Q.raxx XL DAQ systems can utilize an integrated, high-performance controller for communication, control, and data logging purposes. With a controller, multiple Q.raxx XL systems can be synchronized to each other allowing for efficient DAQ distribution with low jitter and gradual expansion up to thousands of channels.

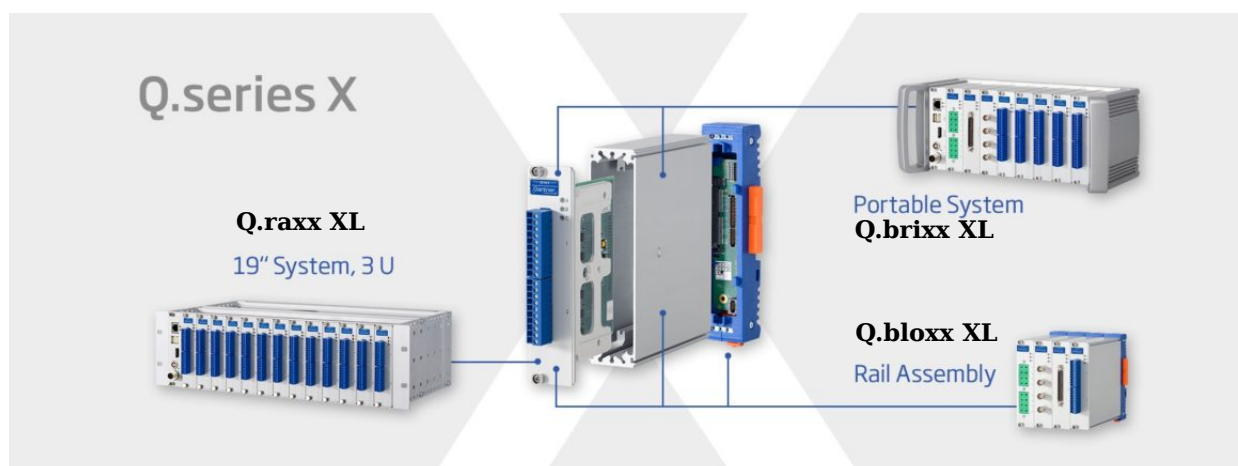

Fig. 3-3 The available form factors for Q.series XL products are Q.bloxx X, Q.brixx X, and Q.raxx X; measurement modules can be interchanged between the three form factors

4

Q.station X (B/T) Interfaces

This chapter details interfaces, pin assignments, LED codes and the functional operation of the programmable and remotely viewable graphic HMI display of the Q.station X Test Controller.

4.1

Mounting and Connecting the Q.station X (B/T)

For the Q.bloxx XL form factor, the sockets (i.e., backplanes) of the Q.station X Test Controller and the Q.series XL measurement modules must each be mounted to a rail prior to system assembly (35mm DIN rail according to DIN EN 60715). See Chapter 5.1, *Mounting Q.bloxx X Systems*, page 37 for more detailed info.

4.2

Pin Assignments for Q.station X (B/T)

Pin Assignments for both Standard and Extended Q.station X.

4.2.1

Pin Assignments for Standard Q.station X (B/T)

The standard features of Q.station X include one Ethernet port, six digital inputs, one DisplayPort, two USB 2.0 ports, one CAN port, one controller Sync port, an internal SD card port, and a POWER interface. The digit input interface is an 8-pole LEMO port and the *POWER* interface is a 5-pole screw port (Fig. 4-1).



Pin	Digital input plug assignment
1 (red marking)	+5 V auxiliary voltage for digital inputs
2	DI1
3	DI2
4	DI3
5	DI4
6	DI5
7	DI6
8	Digital input 0V, GND

Power Supply
5-pole M12 Plug A-Coding

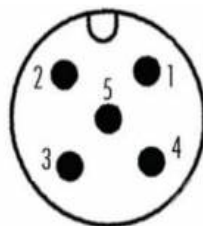

1	+24V Module Supply
2	GND Module Supply
3	GND External Sensor Supply
4	+5-24V External Sensor Supply
5	Potential Equalization (PE)

*Front view of connector on Q.station X. Pin assignments mirrored for included mating connector plug.

**Pin 1 can be supplied with 10-30VDC. Pin 3 and 4 can be used if special sensor supply voltage is needed, e.g., at the VS+ and VS- pins of the UART/POWER module or extension socket. This sensor supply voltage needs to be sourced by an external power supply.

Fig. 4-1 Terminal arrangement for Standard Q.station X (B/T)

4.2.2

Pin Assignments for Standard Features (All Versions)

Digital Input (DI) Interface

Pin	Digital Input Assignment
1 (red mark)	+5 V (Power supply, max. 30V _{DC} , 100mA)
2	DI1
3	DI2
4	DI3
5	DI4
6	DI5
7	DI6
8	Digital input 0V, GND

Fig. 4-2 Pin assignments for the digital input (DI) interface on all versions of the Q.station X (B/T) Test Controller

Input assignment *DI1* is needed if synchronization via IRIG-B or via DIO is desired. Q.station X (B/T) digital inputs are configured using *GI.bench* (Section 7.3, page 153).

Add up to six Q.station X (B/T) digital inputs to the configuration tree: Right-click **Physical variables > Append variable**. Select the desired **dig. input Level** as either **TTL** (<1 V and >3.5 V) or **HTL** (<7 V and > 8 V) by double-clicking on **Physical variables** in the configuration tree or by right-clicking **Physical variables** and selecting **Edit internal module**. Reference Section 7.1.1, page 138 for details on Q.station X settings.

Lifesignal

The **Lifesignal** of the Q.station X (see **Lifesignal Type**, page 24) is available via virtual variable outputs from the Q.station X or any output variable within a Q.series XL system, e.g. A101 digital output.

Configuration for the Lifesignal output of the Q.station X (B/T) is freely configurable in *GI.bench* (Section 7.3, page 153).

Power Supply Interface

Pin	Digital output assignment
1	+24 V, Power Supply (Input) for System
2	GND, Power Supply (Input) for System
3	GND, Sensor Supply (Input)
4	+5-24V Sensor Supply (Input)
5	Potential Equalization (PE)

Fig. 4-3 Pin assignments for the power interface on Q.station X (all types); Sensor Supply inputs require a supply voltage from external source for sensor excitation

i Tip

An unregulated direct voltage between 10V and 30V is needed from the connected power supply. The Q.station X by itself needs approximately 12W of available power. The power required by the Q.station X is almost constant over the entire voltage range.

! IMPORTANT

For the Q.bloxx XL form factor, both the Standard and Extended versions of Q.station X only includes a mating connector needed to connect the *POWER* interface to an external unregulated direct supply voltage between 10V and 30V. Supply not included.

More details on powering Q.bloxx XL modules are available in Chapter 5.3, *Connecting a Power Supply to Q.series XL*, page 47.

CAN Port

CAN port Pin Assignment		Termination
CAN (bottom pin)	H	CAN High
CAN (top pin)	L	CAN Low

Fig. 4-4 Pin assignments for the plug-in CAN bus interface on all versions of the Q.station X Test Controller

We recommend using only shielded CAN bus cable and that the shield is connected flat onto the control cabinet frame. The shield is a Faraday cage screening the CAN twisted pairs from noise so it must be connected to an earth (GND) potential.

Controller Sync Port**Pin Assignments for Q.station X Controller Sync Port**

Sync B (SyB; top pin)	Input and output for synchronization with another Test Controller
Sync A (SyA; bottom pin)	

Fig. 4-5 Pin assignments for plug-in Sync cable (bus) interface

4.2.3

Extended Versions of the Q.station X Test Controller

The extended versions of Q.station X (B/T), i.e., PN, EC, and SSD are double-wide modules that include all the standard interfaces of the Q.station X (B/T). The second card provides an additional interface depending on extension type.

4.2.3.1

Pin Assignments for the Q.station X (B/T) PN

Q.station X (B/T) with Extension module for PROFINET *slave*:

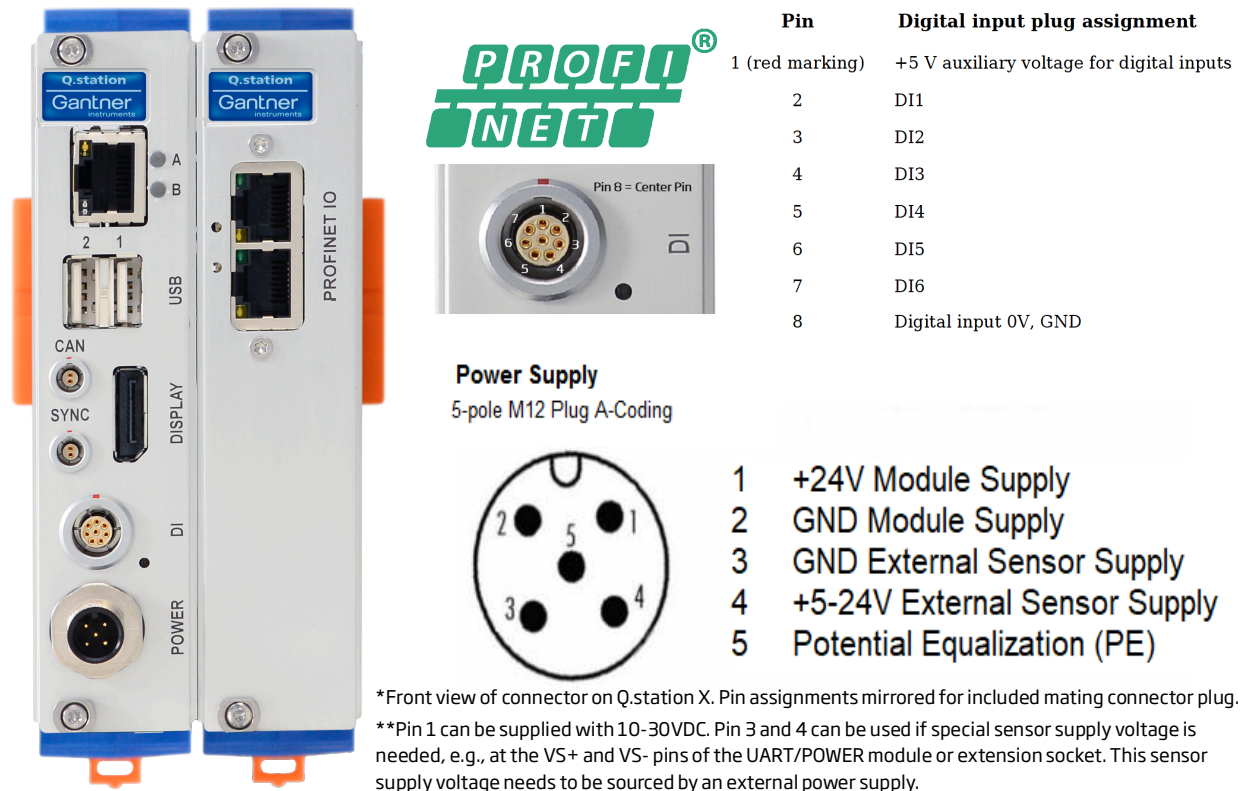

Fig. 4-6 Pin assignments for the Q.station XB PN/ XT PN

The Q.station X (B/T) PN provides an additional interface for PROFINET slave communication. Aside from the added interface for PROFINET slave communication, this extended version of the Q.station X (B/T) does not include additional functionality and does not add to the performance of the Q.station X (B/T). If PROFINET slave communication is not necessary for an application, then the Q.station X (B/T) PN is not necessary.

- 2x RJ45 connectors for PROFINET slave communication
- Sends process variables (1 kHz) to PLC
- Conformance class CC-A
- Addressing DCP (Discovery and Configuration Protocol)
- Supports topology detection, automatic addressing and MRP (Media Redundancy Protocol)

! IMPORTANT

For the Q.bloxx XL form factor, both the Standard and Extended versions of Q.station X only includes a mating connector needed to connect the *POWER* interface to an external unregulated direct supply voltage between 10V and 30V. Supply not included.

4.2.3.2

Pin Assignments for the Q.station X (B/T) EC

Q.station X (B/T) with extension module for EtherCAT interface:

Pin	Digital input plug assignment
1 (red marking)	+5 V auxiliary voltage for digital inputs
2	DI1
3	DI2
4	DI3
5	DI4
6	DI5
7	DI6
8	Digital input 0V, GND

Pin	Power Supply
1	+24V Module Supply
2	GND Module Supply
3	GND External Sensor Supply
4	+5-24V External Sensor Supply
5	Potential Equalization (PE)

*Front view of connector on Q.station X. Pin assignments mirrored for included mating connector plug.

**Pin 1 can be supplied with 10-30VDC. Pin 3 and 4 can be used if special sensor supply voltage is needed, e.g., at the VS+ and VS- pins of the UART/POWER module or extension socket. This sensor supply voltage needs to be sourced by an external power supply.

Fig. 4-7 Pin assignments for the Q.station XB EC / XT EC

The Q.station X (B/T) EC includes an interface for EtherCAT communication. Aside from the added interface, this version of the Q.station X (B/T) does not provide additional functionalities or performance versus the Q.station X (B/T). If an EtherCAT slave communication interface is not necessary for an application, then the Q.station X (B/T) EC is not recommended.

- 2x RJ45 connectors for EtherCAT communication
- Isolation voltage of RJ45 interfaces: 500 VDC
- 253 variable read/write with 100 Mbps
- Cycle time of 100 microseconds

The Q.station X (B/T) EC acts as an EtherCAT slave, but retains the normal functionality of the Q.station X (B/T), e.g., local data logging and evaluation capabilities. Q.station X (B/T) EC is configurable with standard EtherCAT masters, e.g., TwinCAT and KPA.

! **IMPORTANT**

For the Q.bloxx XL form factor, both the Standard and Extended versions of Q.station X only includes a mating connector needed to connect the *POWER* interface to an external unregulated direct supply voltage between *10V* and *30V*. Supply not included.

4.2.3.3

Pin Assignments for the Q.station X (B/T) SSD-1TB

Q.station X (B/T) with extension module that includes 1TB SSD:

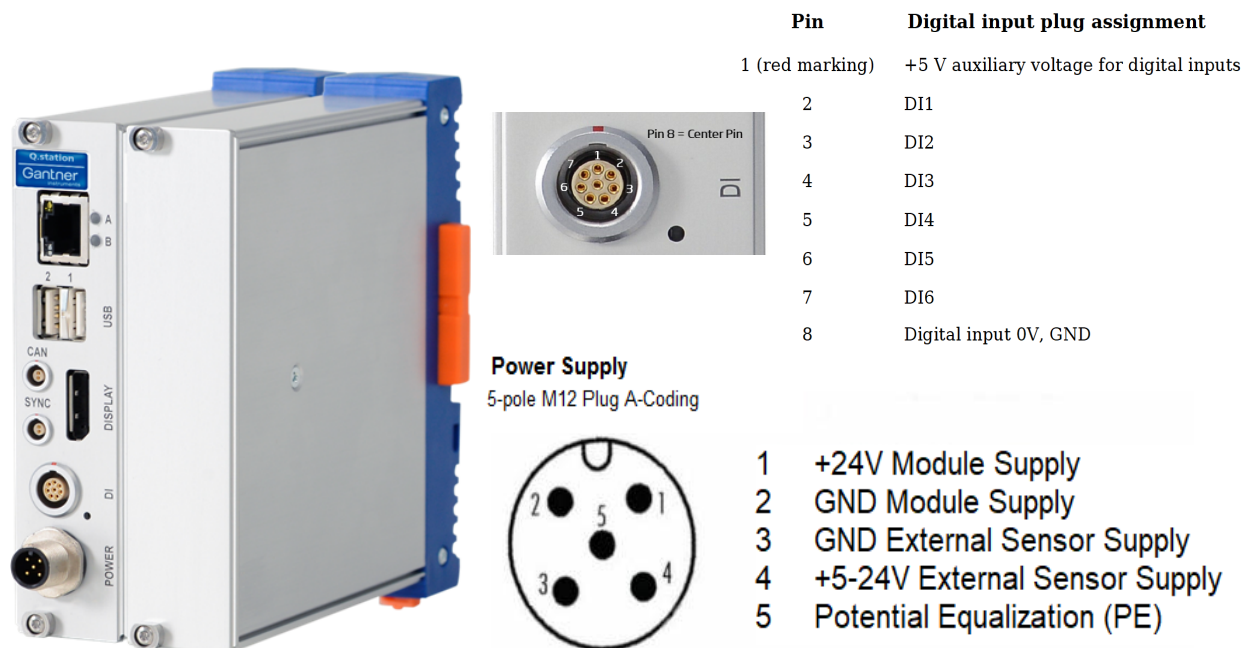

*Front view of connector on Q.station X. Pin assignments mirrored for included mating connector plug.

**Pin 1 can be supplied with 10–30VDC. Pin 3 and 4 can be used if special sensor supply voltage is needed, e.g., at the VS+ and VS- pins of the UART/POWER module or extension socket. This sensor supply voltage needs to be sourced by an external power supply.

Fig. 4-8 Pin assignments for the Q.station X (B/T) SSD-1TB

The Q.station X (B/T) SSD-1TB includes a 1TB SSD for increased integrated storage. Aside from this added benefit, this extended version of the Q.station X (B/T) does not provide additional functionalities or performance versus the standard Q.station X (B/T).

! **IMPORTANT**

For the Q.bloxx XL form factor, both the Standard and Extended versions of Q.station X only includes a mating connector needed to connect the *POWER* interface to an external unregulated direct supply voltage between *10V* and *30V*. Supply not included.

4.3 Communication and Storage Interfaces

4.3.1 Ethernet Port

The Ethernet port utilizes standard contact pin assignments so it is possible to directly insert any standard Ethernet (RJ45) cable.

Cross Ethernet cables are not necessary for a Q.station X Test Controller, however if a cross cable is required for an application, the switchover occurs automatically within the Q.station X.

We recommend Ethernet cables of Category 5 (Cat-5) or better.

4.3.2 USB 2.0 Ports

The pin assignments of the USB ports are standard USB 2.0, so any standard USB drive is compatible with the Q.station X. The USB drive(s) must be formatted as either *ext3* or *FAT32*; *other formats, such as NTFS, are not compatible.*

NOTICE

The USB 2.0 interfaces can accept a current load of up to 100mA. Use a separate power supply for devices with higher current requirements (include start-up current, e.g., external hard disks).

The maximum transfer rate of USB 2.0 is approximately 4 MB/s and the actual transfer rate is dependent on whether 4 MB/s is supported by the connected USB memory device.

Refer to Chapter 9, *Record Data with Loggers*, page 181 for details regarding how to store data on a USB drive via the data logger.

! IMPORTANT

Please note that when accessing the Q.station X via FTP, USB#1 will be displayed as USB0 and USB#2 will be displayed as USB1.

4.3.2.1 CAN or CAN FD via USB 2.0

The USB 2.0 interfaces can also be utilized to read and write CAN or CAN FD data via a compatible USB-to-CAN/FD dongle. Refer to Section 7.4.2, *Defining CAN Signals*, page 158 for information regarding CAN and CAN FD. For CAN, however, direct connection via the CAN port is recommended.

4.3.3

SD card Port (Internal Only)

An SD card can be utilized as a data logger storage destination and for internal memory expansion. The SD card port is located inside of the Q.station X (B/T) Test Controller, directly on the CPU board, and can only be accessed by removing the Test Controller from its socket.

You can use all commercially available standard SD cards which are formatted with *ext3*, *FAT32*, or *NTFS*; other formats are *not compatible*.

- ➔ We recommend SDHC Class 10 SD cards from SanDisk or PNY, with a writing speed of more than 30 MB per second (e.g., the PNY 32 GB SD card has a data rate of up to 95 MB per second). Note that any speed indicated on an SD card is only the top potential speed for that task. This information would say nothing about the continuous transfer rate, or whether you can store with this speed over longer periods. Often the speeds for reading and writing (usually smaller) are given separately.

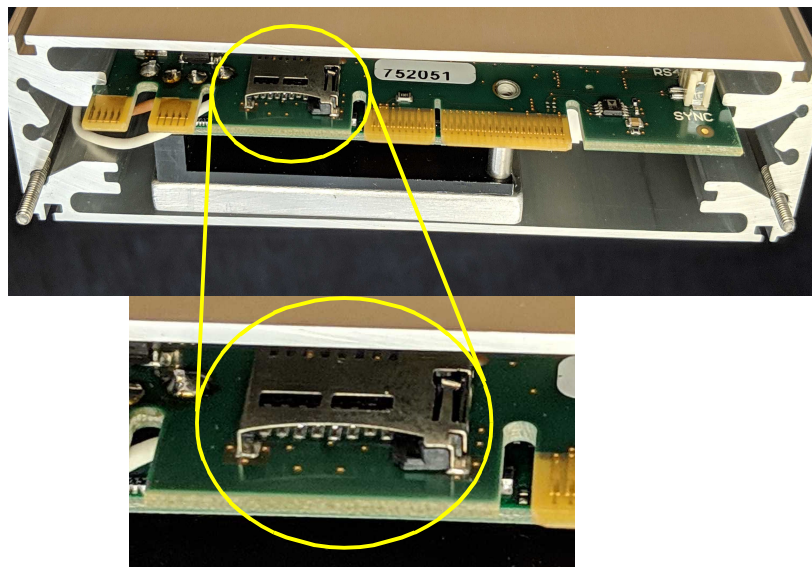

Fig. 4-9 Q.station X (B/T) internal SD card port

You have options when attempting to access recorded data on the internal SD of the Q.station X or operate the Q.station X remotely:

1. From a connected PC, access the connected drives of the Q.station X, e.g., Q.station X internal memory, **hd0**, through the use of SMB/CIFS (see Section 10.1, page 201) or mapping the Q.station X as a Network drive (Section 10.1.2, page 204).
2. You can transfer the data from the Q.station X to an FTP server. Details are available in Section 7.1.3.3, *FTP Clients*, page 146.

4.4 Q.series XL LED Flash Sequences

4.4.1 LED Codes for Q.station X (B/T) Test Controllers

Q.station X has two in-line LEDs at the front upper-right edge: a blue LED labeled *A* and an orange LED labeled *B*.

In normal operation, the blue LED labeled *A* will be solidly on, i.e., no flashing whatsoever, while orange LED *B* will be off.

Depending on the errors or events that occur, the LEDs will flash in certain sequences providing the user a code to interpret the status of the Q.station X Test Controller.

4.4.1.1 No Configuration Errors; Normal Operation

Blue LED *A* is solid on (not flashing). Orange LED *B* is always off.

4.4.1.2 Storage to External Memory Device is Active

Blue LED *A* flashes quickly. The external memory device, e.g., a USB drive, when LED *A* is no longer flashing.

4.4.1.3 Error (System Fault)

Orange LED *B* periodically flashes when there is a system fault while Blue LED *A* remains solid on (not flashing).

- ➔ If the error status does not indicate the nature of the fault or if you do not know how to correct the fault, please contact Gantner Instruments or your domestic Gantner Instruments Sales and Service location for technical support.

4.4.1.4 Firmware Error

Orange LED *B* is solid on (not flashing): the firmware could not be loaded.

Blue LED *A* is always off: the FPGA cannot load the firmware.

Try a full system restart (power cycle the Q.station X). If this does not solve the firmware error, please contact Gantner Instruments or your domestic Gantner Instruments Sales and Service location for technical support.

- ➔ If both the orange LED *B* and blue LED *A* are solid on (no flashes) for longer than approximately two minutes, then it is likely the firmware update process could or has failed. Attempting a firmware update again could solve the issue. If it does not, please contact Gantner Instruments or a domestic Gantner Instruments Sales and Service location for technical support.

4.4.2

LED Codes for Q.series XL Measurement Modules

Modules have three in-line LEDs on the front upper right edge: Blue LED on top, Green LED in middle, and Red LED on bottom.

In normal operation, all three LEDs are solidly on with no flashes. Depending on the error or operational procedure that occurs, the LEDs will flash in certain sequences providing the user a code to either diagnose the problem or be aware of module status.

In the following illustrations a short dash corresponds to short flash and a long dash to a long flash.

4.4.2.1

SOS; Configuration Error



Fig. 4-10 Flashing sequence indicating an incorrect module type or there are no configurations stored in the socket

The configuration saved in the socket EPROM does not match the configuration within the connected module.

There are two likely reasons for this:

1. No stored configuration data exists in socket EPROM while *hot-swap* is enabled, i.e., when configuration data is expected.
2. The module type of the stored configuration data in the socket EPROM differs from the type of the connected module, thus a configuration incompatibility exists between both devices.

To remedy this, either change the module to the correct module type (same as stored in EPROM) or reconfigure the module via *GI.bench* (Chapter 8, *Configure the Modules*, page 165). The new configuration is automatically saved to the socket EPROM.

4.4.2.2

Firmware download in progress



Fig. 4-11 Flashing sequence on downloading the module firmware

Module LEDs flash while the firmware download into the module is taking place. This is an operational procedure status LED code and does not indicate an error has occurred. No further action is required.

4.4.2.3

Activation of downloaded firmware

Fig. 4-12 Flashing sequence on activating the firmware

After the firmware has been downloaded, module LEDs will sequentially flash from top to bottom while the new firmware reconfigures the FPGA. Once complete, the module must restart. This is an operational procedure status LED code and does not indicate an error has occurred. No further action is required.

4.4.2.4

Failure during module start sequence

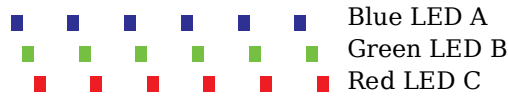
Fig. 4-13 Flashing sequence due to errors during module startup

Irregular Blue LED A flash sequences, as shown above, indicate a failure occurred during module startup:

- If Blue LED A flashes twice repeatedly, then the module is in the OS and detected an error during startup.
- If Blue LED A flashes repeatedly, then the module is in the APP and detected an error during startup.

In either case, the Red LED C will flash to indicate an error code:

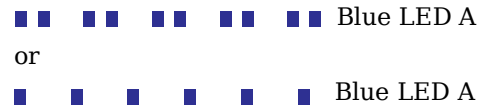
Check the following to determine a cause:

1. Are all the linking interfaces between module CPU boards and socket boards intact (e.g., internal components of modules)?
2. Are all the linking interfaces between all sockets (e.g., all exposed boards and their mating ports) completely intact and securely connected to form a single backplane?
3. Are all interface cables, if any, properly wired?
4. Are all linking interfaces between measurement modules and Test Controller completely intact and connected properly?

After checking the above, restart the Q.station X by power cycling the connected voltage supply (wait for at least 60 seconds before turning the supply on again).

If the communication error is not remedied after the above steps, contact Gantner Instruments or your domestic Gantner Instruments Sales and Service location for technical support.

4.5

Operating Q.station X via DisplayPort or VNC

4.5.1

Q.station XB - PN / EC / SSD-1TB (“non T-versions”)

The Q.station XB - PN / EC / SSD-1TB Test Controllers include a Human Machine Interface (HMI) display via either the DisplayPort or VNC (see Section 10.2, page 206). The HMI display can provide a system overview and the ability to view and change Online measurement values as well as the controller’s IP address.

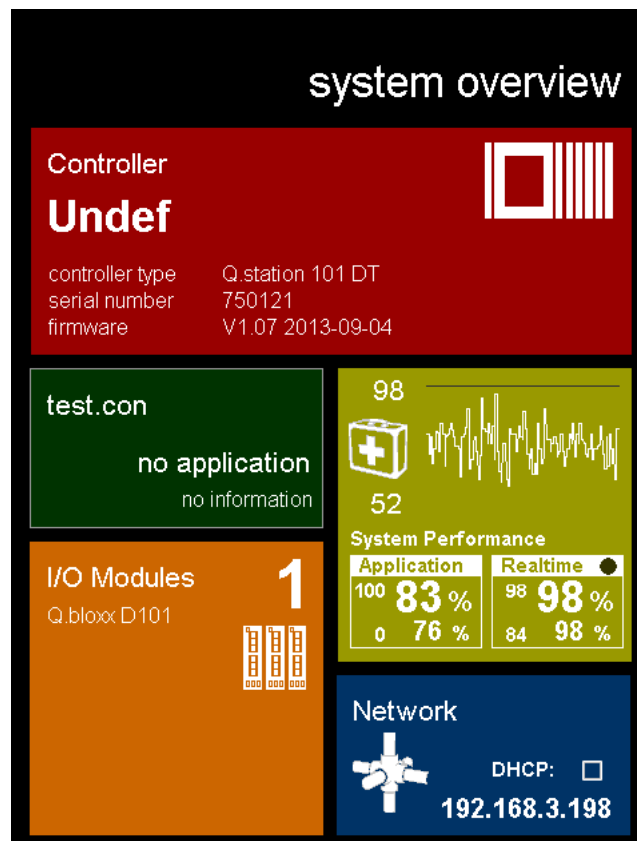

Fig. 4-14 Q.station X default graphical HMI display (main screen)

The factory default display includes five standard tiles:

- A **Controller** tile with information on the type, serial number and firmware version. Tapping on the tile displays the active measurement channels and their Online values.
- A **test.con** tile; If custom screens or functionalities have been defined in *test.con*, they can be viewed and operated here.
- An **I/O modules** tile that provides the number and type of all connected modules. Tap on the tile in order to view or select modules or their channels individually for display (as graphs).
- A **graph** tile providing a live display of system performance.
- **Network** with the settings for the network interface. Tap on the tile to show the subnet mask and gateway address.

4.5.2

Q.station XT - PN / EC / SSD-1TB (“*T-versions*”)

A Programmable Automation Controller (PAC) permits complex control functionality such as PID controllers, state machines, arithmetic functions, numeric and logical operations, transmission terms, function generators, time functions, visualization and additional functionalities.

Only Q.station XT - PN / EC / SSD-1TB (*T-version*) Test Controllers provide PAC functionality *and* a programmable graphical Human Machine Interface (HMI). Via the software *test.con*, users can design HMI screens that are unique to applications and incorporate complex calculations and functionalities, that operate both manually and automatically, as needed.

The software *test.con* is an easy-to-handle graphical programming tool for defining Q.series and Q.series X PAC functionality. As only graphical blocks are used for programming in *test.con*, time to get familiarized with the system is minimized.

With *test.con*, programming can be performed on a data flow basis (function block language) or by following the control flow (sequences, flow charts). Structure blocks permit a hierarchic structure of projects. Linked projects and export mechanisms facilitate the reuse of structure blocks that have been created previously. Special blocks and additional tools permit Online observation of signals and signal tracing as well as run-time measurements. Therefore, *test.con* combines programming, simulation, testing and operation in one tool.

Digital graphical HMI displays can be remotely viewed and operated via VNC or a touch panel display connected via the DisplayPort on the Q.station XT. If compatible, a touch panel display can be navigated by directly pressing on the desired tile whereas VNC produces a window of the HMI on a PC.

Refer to Section 10.2, *Remote Control Q.station X via VNC*, page 206 for more information regarding viewing and operating the Q.station X (B/T) Test Controller via TightVNC Viewer.

- ➔ Download *test.con* (version 6.2.0 or higher for Q.station XT) for free on our website at www.gantner-instruments.com. For more instructional material related to *test.con*, visit <http://testcon.info>.

For additional information regarding the optional Programmable Automation Controller (PAC) functionality for test automation, configurable via the software *test.con*, contact your domestic Gantner Instruments Sales and Service location for assistance.

5

System Assembly & Setup

This chapter describes the connection and pin assignments of the Q.series XL measurement modules. Refer to Chapter 4, *Q.station X (B/T) Interfaces*, page 23 for interfaces of the Q.station X.

5.1

Mounting Q.bloxx X Systems

For the Q.bloxx XL form factor, the Q.station X Test Controller and sockets (i.e., backplanes) of the Q.series XL measurement modules must each be mounted individually to the rail first (35mm DIN rail according to DIN EN 60715). See Section 5.2.5, page 43 for more detailed instruction on mounting sockets.

Once installed on mounting rail, the sockets can then be pushed together and connected with the Q.station X to become a single backplane. Make sure to include a pair of *black plastic inserts* on the right hand side of each module before connecting them to their respective socket as the inserts provide guidance for the insertion of the following module (last module not necessary).

! IMPORTANT

The DIP switch terminal on the Q.series XL module board (CPU) for *RS485 interface (UART)* and *terminating resistor* as well as the DIP switch terminal on the socket for *module address* and the *hot-swap* feature, must both be configured prior to mounting the modules to their respective sockets (Fig. 5-1 & Fig. 5-2, page 39).

With the modular backplane assembled, the Q.series XL measurement modules can be connected to their respective sockets; start with the left-most socket adjacent to the Q.station X and sequentially install each module going towards the right. Once the modules are inserted into their respective sockets, tighten the front-facing screws on each module.

5.2

The Q.series X Socket

The socket of a Q.series XL module is the smallest unit within the modular Q.series XL backplane. The backplane is responsible for supplying power to each module, system synchronization, system configuration, and measurement data transfer. Each Q.series XL module is electrically grounded to the mounting rail it is installed on (DIN 35mm rail according to DIN EN 60715) via the metal spring on the bottom the socket. In addition, standard features of the Q.series XL socket include the ability to activate terminating resistors, storage of connected module configuration data, and the restoration of module configuration data upon inserting a module of the same type (i.e., *hot-swap*; Section 5.2.2, page 40).

! **IMPORTANT**

The last module of each RS-485 interface (UART) must be terminated with a resistor. If a UART is not terminated, reflections may occur on the bus leading to disturbances (noise) or even to loss of data transmission. See Section 5.2.4, page 42 for more details.

Q.series XL modules can operate in the following modes:

- *Without stored or DIP switch configuration, i.e.,* module is configured via software on a connected PC, e.g., *GI.bench*.
- *With address configuration, i.e.,* module address is set via DIP switch on the socket. All other configurations are made via a connected PC. In this mode, addresses set via software are superseded by the address configured via DIP switch.
- *With stored boot configuration (factory default setting), i.e.,* module can be replaced at any time by another of the same type, i.e., hot-swap feature. The module configuration data via *GI.bench* is also stored in the socket and automatically downloaded by a new module of the same type once it is inserted. With the hot swap feature activated, measurement mode can continue while replacing a defective or compromised module without having to spend time manually reconfiguring the new module. The saving of configuration data in the socket occurs automatically via configuring the module using *GI.bench*.

! **IMPORTANT**

All desired DIP switch settings must be configured before the modules are inserted into their respective sockets.

5.2.1

Configure Operating Mode

The module's overall operating mode is configured across two sets of DIP switch terminals: one terminal is on the module's CPU board and the other terminal is on the socket.

Module addresses can be defined via the DIP switch terminal on the socket, e.g., see Fig. 5-1, page 39. On the socket, DIP switch terminal positions (or bits) 1 through 7 are for assigning module addresses in binary form. Socket DIP switch bit 8 is used to activate (bit OFF) or deactivate (bit ON) the hot-swap feature.

i **Tip**

While configuring module addresses, it is always recommended to start with an address of "1" on each RS-485 interface (UART).

To activate DIP switch positions, ensure they are pushed towards the side labeled "ON" as shown in Fig. 5-1 & Fig. 5-2 on page 39.

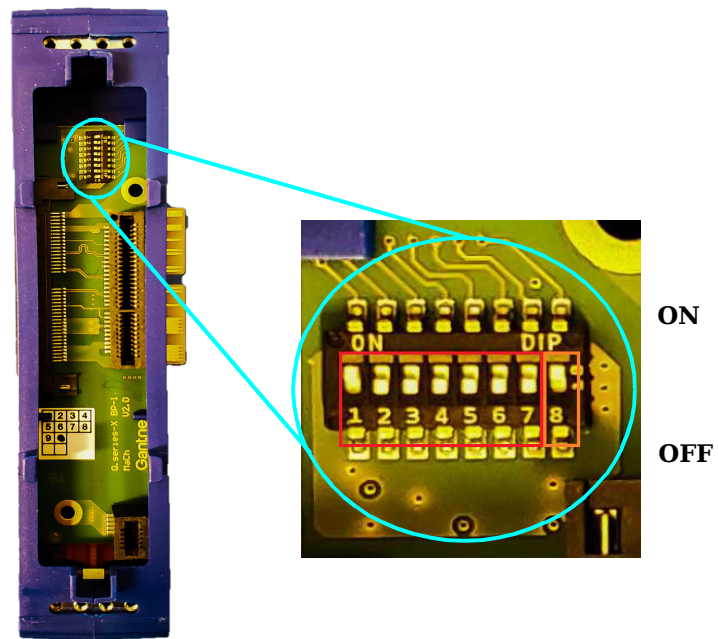

Fig. 5-1 DIP switch terminal on Q.bloxx X socket, positions (bits) 1 through 7 are used for binary addressing (red) of module and hot swap de-/activation is possible via bit 8 (orange)

The RS-485 slave interface (UARTs 1 through 4) and terminating resistor are set via the DIP switch inside the Q.series XL module directly on the CPU board (see below in Fig. 5-2).

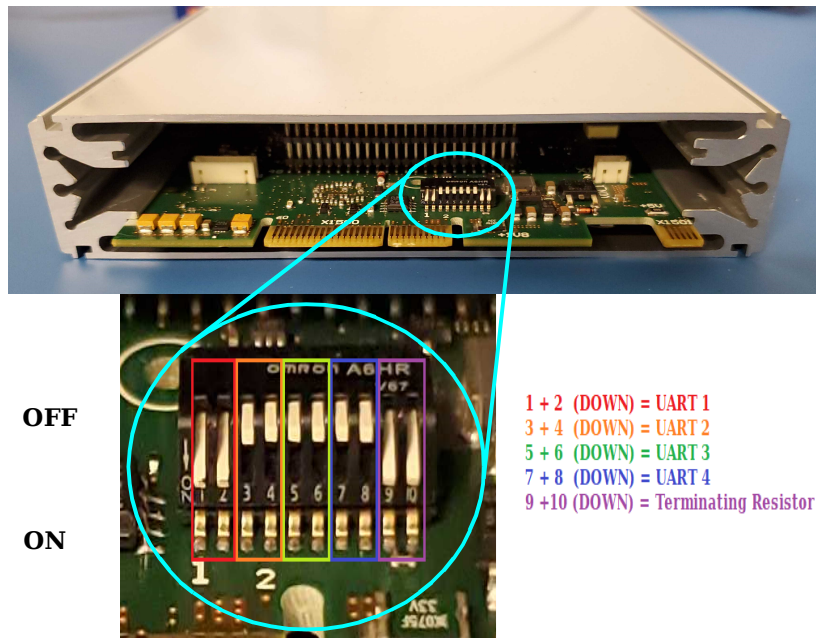

Fig. 5-2 DIP switch on the Q.series XL module CPU board, UARTs are assigned via position pairs 1+2, 3+4, 5+6, and 7+8 (red, orange, green, and blue). Positions 9+10 activate the terminating resistor used to end the UART (purple)

5.2.2

The Hot-swap Feature

Hot-swap, i.e., a factory default setting (operating mode) where module configuration data is stored in the socket (Q.series XL modular backplane) EPROM (boot configuration). Configuration data can then be downloaded from the socket EPROM enabling the user to replace defective or compromised modules with new ones of the same type without manually reconfiguring modules.

! IMPORTANT

With hot-swap activated (factory default setting), any previous configuration data within a replacement Q.series XL module may be overwritten without warning after system integration. Ensure that replacement modules are selected carefully and that all configuration files are backed up prior to swapping the modules.

If a module socket does not contain configuration data or if the configuration data stored in a socket does not match the module type that is inserted, then the module LEDs will flash SOS (refer to Section 4.4.2.1, *SOS; Configuration Error*, page 32):

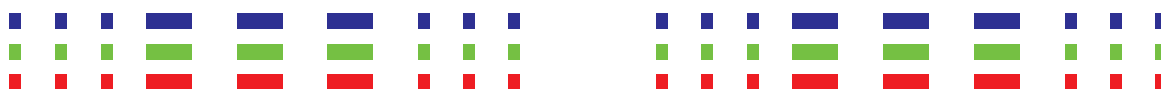

Fig. 5-3 LED flashing sequence indicating an incorrect module has been inserted or that there is no configuration data in the socket; short dashes correspond to a brief flash while long dashes correspond to a prolonged flash

Q.series XL modules are only ready for measurement once valid configuration data has been loaded to them. Typically and initially, all module configurations are downloaded via *GI.bench*. With hot-swap enabled, configuration data that is written to the module via *GI.bench* is also automatically stored in the socket EPROM as a backup configuration file. If during measurement, a module needs to be replaced, the new replacement module will automatically adjust its configurations to match the stored data.

! IMPORTANT

DIP switch bit 8 on the socket toggles the *hot-swap* functionality (Fig. 5-1, page 39). If *hot-swap* is deactivated with configurations stored in the socket EPROM, the module receives configurations via *GI.bench* instead of reading the stored data in the EPROM.

An address can also be assigned to a modules via the same DIP switch terminal that is used to activate the hot-swap feature. DIP switch settings for module address must be (OFF) in order to be able to assign module addresses via *GI.bench* again (please refer to Fig. 5-1, page 39 and Section 5.2.3, page 41).

5.2.2.1

Transferring Configuration Data to the Socket

When a module receives configuration changes via *GI.bench*, the new configuration data is automatically transferred to the socket as well, even if the hot-swap feature is *disabled*. This process ensures that the same configuration data exists in the socket EPROM and module at all times. This allows the socket to provide the benefits of hot-swap whenever the feature is *enabled*, without having to reconfigure the module via *GI.bench*. Transfer of configuration data from socket to module only occurs when the hot-swap feature is *enabled* (see Fig. 5-1, page 39).

Replacing Sockets

1. Turn off or disconnect the power supplied to the system.
2. Remove the module from the socket to be replaced, then remove the socket from the system backplane.
3. *Enable* the hot-swap feature on the new (replacement) socket: Push DIP switch bit 8 downwards (OFF) on the new socket.
4. Mount new socket (Section 5.1, page 37) to the backplane.
5. With the new socket connected to the backplane, turn on or reconnect the supply voltage to power the system.
6. Plug the module into the powered (new) socket.
The module's flashing LEDs indicate the module is checking its own configuration data and the socket EE data; if no data is detected in the socket EE, the module will flash SOS as shown in Fig. 5-3, page 40. If the module is flashing SOS, rewrite the *GI.bench* project configuration to the module.
7. Wait until the LEDs are no longer flashing (either solid or off).
With hot-swap enabled, the configuration data stored in the module is overwritten by the configuration data present in the socket EPROM, if the configuration data in the socket EPROM matches the module-, submodule-, and function-types of the module inserted.

5.2.3

Configure Module Addresses via DIP Switch (Optional)

Module addresses can be set in binary form via the first seven DIP switch positions located on each socket. Setting addresses in this manner is optional; an address of "0" corresponds to *not set* and the module must then be assigned an address via *GI.bench*.

Modules are shipped from Gantner Instruments with a default address of "1" set via the DIP switch on the socket. It is imperative that all new modules be assigned an appropriate address, either via the socket DIP switch terminal or *GI.bench*.

If modules are addressed via socket DIP switch terminal, then module addresses attempted to be configured via *GI.bench* are instead stored in the module and are only used if the DIP switch address is set back to "0" at any time.

! **IMPORTANT**

If several modules with the same address exist within a UART, measurement will *not* be possible (see Section 6.3, page 120).

Module Address	S1	S2	S3	S4	S5	S6	S7
0	OFF ¹	OFF	OFF	OFF	OFF	OFF	OFF
1	ON ¹	OFF	OFF	OFF	OFF	OFF	OFF
2	OFF	ON	OFF	OFF	OFF	OFF	OFF
3	ON	ON	OFF	OFF	OFF	OFF	OFF
4	OFF	OFF	ON	OFF	OFF	OFF	OFF
5	ON	OFF	ON	OFF	OFF	OFF	OFF
...
30	OFF	ON	ON	ON	ON	OFF	OFF
31	ON	ON	ON	ON	ON	OFF	OFF
32	OFF	OFF	OFF	OFF	OFF	ON	OFF
...
62	OFF	ON	ON	ON	ON	ON	OFF
63	ON	ON	ON	ON	ON	ON	OFF
64	OFF	OFF	OFF	OFF	OFF	OFF	ON

¹⁾ OFF = Down; **ON** = Up; DIP switch in Fig. 5-1, page 39

➔ Socket of Q.station X Test Controller should *not* have an address.

Refer to Section 6.4, *Establish a Connection*, page 124 for information on configuring addresses via *GI.bench*.

5.2.4

Activating Terminating Resistances in Modules

Terminating resistances must be activated inside the last module of each RS-485 interface (UART) line, i.e., UARTs must be terminated via a DIP switch terminal available on each module CPU board (see Fig. 5-2, page 39). Data reflections can occur on a UART line, leading to noise and other disturbances such as loss of data transmission, if a UART line is not properly terminated.

Activate resistors via DIP switch terminal on module CPU board:

- Push down on DIP switch terminal positions 9 + 10 to activate the terminating resistor (see Section 5-2, page 39).

! IMPORTANT

Terminating resistances *must only* be activated at the last module of the RS-485 interface (UART) line. If terminating resistances are activated within a UART, the data stream (signal) is weakened and interferences, e.g., interruptions in data transmission occur for all modules located after the terminating resistances.

Terminating Resistances and Q.bloxx X Extension Socket (QXES)

If you are using the Q.bloxx X Extension Socket (QXES) and have activated bus crossover, then you must push down on DIP switch terminal positions 9 and 10 inside the module directly preceding the Q.bloxx X Extension Socket (QXES), i.e., activate resistances terminating the previous UART line. At the end of the following UART, i.e., after the Q.bloxx X Extension Socket (QXES), terminating resistors must be activated again inside the last module. Refer to Section 5.2.6, *Q.bloxx X Extension Socket (QXES) (QXES) (Left / Right)*, page 44.

5.2.5**Mounting and Removing Q.bloxx X Sockets**

The Q.bloxx X Standard Socket can rest directly on the top edge of mounting rail (35 mm DIN rail according to DIN EN 60715) and can be secured in place by pushing in the orange tab on the bottom of the socket.

Once a socket is secured to rail, it can be pushed with some effort to another socket to connect as one. It is recommended to build systems using this method, from left to right, sequentially mounting and then connecting sockets to one another. Press sockets firmly together as there should be no space between the sockets (see Fig. 5-4).

- ➔ We recommend that a socket is only connected to a power supply after being properly mounted. For information on powering the Q.series XL system, please refer to Section 5.3, page 47.

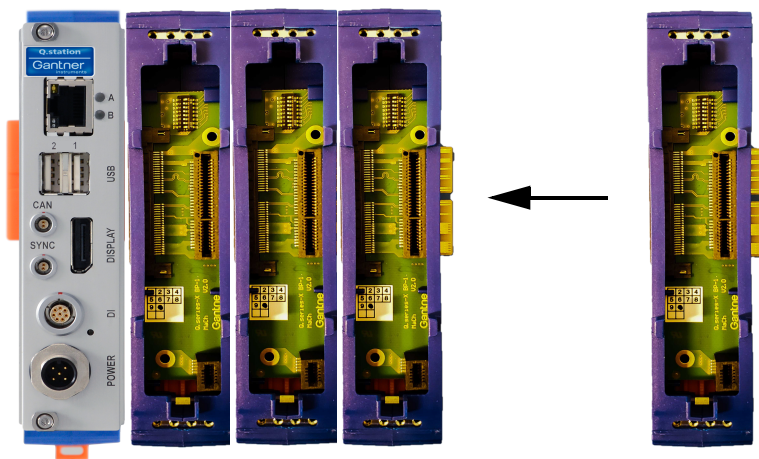

Fig. 5-4 Connecting Q.station X and Q.bloxx X sockets together

To remove a socket with limited clearance, you may use a narrow screwdriver to pull down on the orange tab on the bottom of the socket. At this point, the socket is only hanging on the rail and can be removed by slightly lifting the socket off the rail. With great care, entire systems can be lifted off rail if all orange tabs are unlocked, however this method can invite unnecessary risk to both the system and personnel. It is always recommended to assemble and disassemble systems directly on mounting rail.

5.2.6

Q.bloxx X Extension Socket (QXES) (QXES) (Left / Right)

If you need to connect more than 16 modules, need additional inputs for supply voltage, or need to distribute I/O modules over a distance, the Q.bloxx X Extension Socket (QXES) is required. Q.series XL modules can each be configured for any of the four UARTs and entire systems can be connected in series, however, such system structures are not always feasible, i.e., it is likely that a physical break of modules connected in series is necessary for a feasible system structure assembly.

For decentralized and daisy chained I/O modules, the *Q.bloxx X Extension Socket (QXES) Left* is required to connect the necessary UART and power supply connections to one or more I/O modules.

For connections to additional I/O modules, the *Q.bloxx X Extension Socket (QXES) Right* is used to extend the existing UART and power supply connections to a *Q.bloxx X Extension Socket (QXES) Left*.

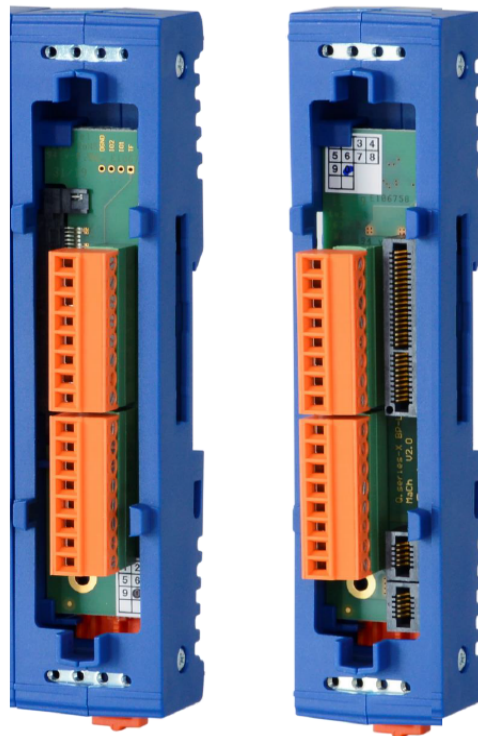

Fig. 5-5 *Q.bloxx X Extension Socket (QXES) Left (left) and Right (right)*

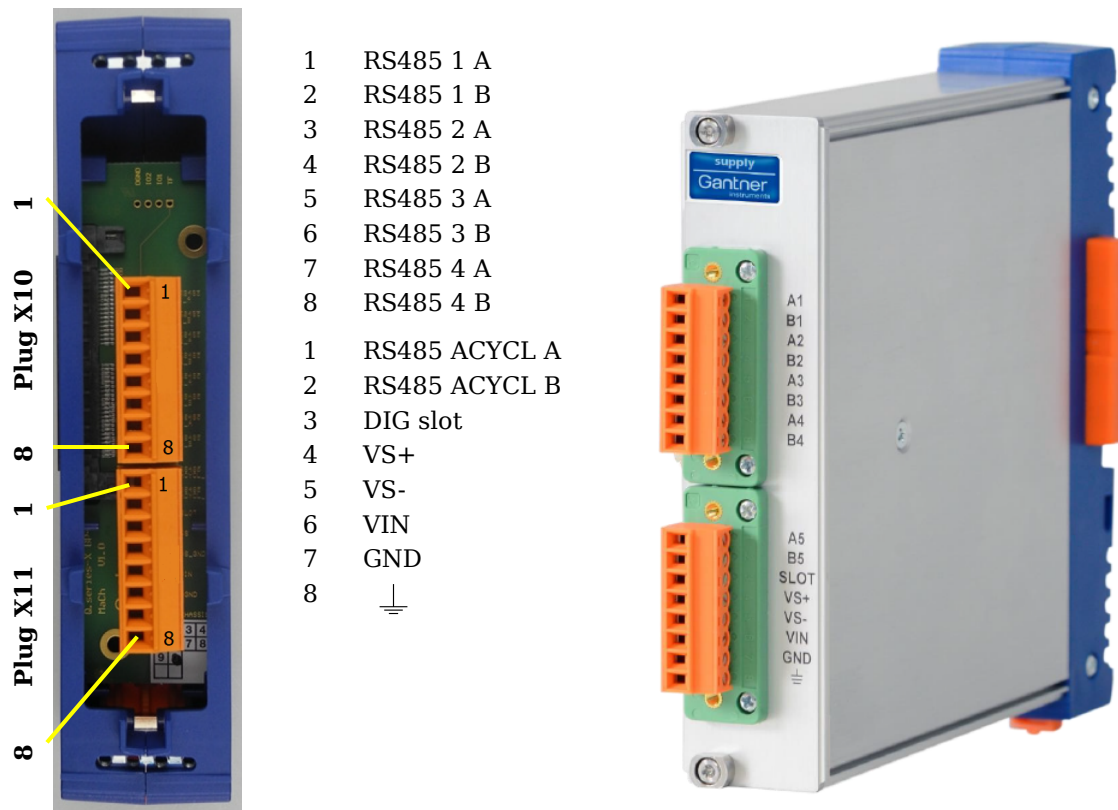

Fig. 5-6 Pin assignments for the Q.bloxx X Extension Socket (QXES); also shown, alternative form factor with module casing (right)

Since only 16 modules per UART are possible, additional modules will require additional UARTs. Therefore, if possible to do so, we recommend using the transition points between UARTs as the physical breaks of modules connected in series, if such breaks are necessary, e.g., for distributed setups.

Note that introducing a physical break of modules connected in series, i.e., introducing the need for cable of any length for data transmission, also introduces potential reductions in the maximum possible baud rate of the bus (more information in Section 7.1.2.1, page 142). UART interfaces are accessible via the extension socket (Left/Right) if a physical break is required. The best bus termination is achieved when the resistor is connected to the extension socket connector Right.

- ➔ Each extension socket (Left/Right) has a bus connector on only one side. The appropriate extension socket type (Left or Right) must be used as required. Modules following the extension socket Left can only be connected to power via the pins on the extension socket Left. All modules preceding the extension socket Right must be supplied power either via the previous extension socket (Left) or via the Test Controller on the far left.

QXES in Systems with LESS than 16 Modules

The Q.bloxx X Extension Socket (QXES) can be used to:

1. Obtain another interface for the external voltage supply.
2. Introduce a physical break in the bus line for the distribution of modules over a distance.

Ensure that all DIP switch terminals on the module CPU boards (see Fig. 5-2, page 39) are configured to the appropriate UART as such UART transitions may still be necessary for systems with less than 16 modules, e.g., systems configured for sampling rates exceeding 10kHz.

Ensure that all UARTs are terminated on the last module; refer to Section 5.2.4 on page 42 for details regarding the necessity of terminating UARTs.

Pin assignments for the Q.bloxx X Extension Socket (QXES) can be seen in Fig. 5-6, page 45, and are identical for left and right versions of the QXES.

A physical break in Q.bloxx X modules connected in series with a Q.station X (line bus) requires a Q.bloxx X Extension Socket (QXES) at either end of each UART, i.e., in order to provide the terminations necessary for connecting or powering the system (use *Left* and *Right* versions of Q.bloxx X Extension Socket (QXES) as needed, refer to Fig. 5-6, page 45).

QXES in Systems with MORE than 16 Modules

Additional inputs for external supply voltage are necessary for systems exceeding 16 modules. The Q.bloxx X Extension Socket (QXES) can provide the additional inputs necessary to connect supplementary power for the modules directly following. Additionally, the QXES can potentially be a convenient source of external supply voltage for sensors along the same bus line.

Pin assignments for the Q.bloxx X Extension Socket (QXES) can be seen in Fig. 5-6, page 45, and are identical for left and right versions of the QXES.

The DIP switch terminals on all module CPU boards must be set to the appropriate UART and all necessary terminating resistors should be activated (refer to Fig. 5-2, page 39 and Section 5.2.4 on page 42, respectively).

Terminating Resistances and Q.bloxx X Extension Socket (QXES)

If you are using the Q.bloxx X Extension Socket (QXES) Right, then you should push down on DIP switch terminal positions 9 and 10 inside the module directly preceding the Q.bloxx X Extension Socket (QXES) Right, i.e., activate resistances terminating the previous UART line. At the end of the following UART, i.e., after the next Q.bloxx X Extension Socket (QXES) Right, terminating resistors must be activated again inside the last module. Refer to Section 5.2.6, *Q.bloxx X Extension Socket (QXES) (QXES) (Left / Right)*, page 44.

5.3

Connecting a Power Supply to Q.series XL

For a power supply, an unregulated direct voltage between 10V and 30V is required. The Q.bloxx X form factor of the Q.station X will only include the mating connector needed for an external power supply to be wired to the *POWER* interface on the front of the Test Controller, as shown in Fig. 4-1, page 23.

Power supplied to the Q.station X will be carried to all modules via all sockets (i.e., modular backplanes) directly connected to the Test Controller in series. The Q.station X itself requires approximately 12W of power to operate in addition to the power supplied to all connected devices.

Each module requires approximately 3W to 3.5W of power in addition to the power supplied to all connected transducers (sensors). Power required is almost constant over the complete voltage range.

! IMPORTANT

When the modules are powered on, there is an increased current draw from the them until they are all in stable operation: During the start-up phase, up to 700mA (10 ms) per module is needed, depending on the supply voltage. Thereafter, you should expect approximately 500mA per module for a 10V supply or if using a 30V supply voltage, expect approximately 170mA draw per module. You should therefore only use power supplies which can either *deliver the required peak power when the voltage is switched on* or – and especially with many modules – *power all modules in groups via multiple external power supply units*.

A physical break in Q.bloxx X modules connected in series with a Q.station X (in-line bus) requires a Q.bloxx X Extension Socket (QXES) at either end of each UART, i.e., in order to provide the terminations necessary for wiring the system (use *Left* and *Right* versions of Q.bloxx X Extension Socket (QXES) as needed, refer to Fig. 5-6, page 45).

Modules have an internal self-healing (reversible) fuse to protect against overvoltages, overcurrents and incorrect polarity.

The range of acceptable wire diameters to connect terminals is 0.14mm² *minimum* to 1.5mm² *maximum*:

- Wire-ends that **do not** have plastic sleeves, acceptable range is 0.25mm² *minimum* to 1.5mm² *maximum*.
- Wire-ends that **do** have plastic sleeves, the acceptable range is 0.25mm² *minimum* to 0.5mm² *maximum*.

No more than 16 modules should be supplied through sockets connected in series. Additional modules will require another line for voltage supply, e.g., via the Q.bloxx X Extension Socket (QXES).

5.4

Inserting and Removing Modules from Sockets

Once you have mounted the sockets to rail and connected them as necessary, modules can then be plugged into their sockets starting with the module directly following the Q.station X.

To do this, ensure that the module is properly oriented with respect to the socket prior to insertion, i.e., such that the module CPU board can insert into the appropriate terminal in the socket. The proper orientation has the orange tab of the socket on the bottom side of the assembled module and the blue label with module name on the top side of the assembled module. It is recommended to push the long front-facing screws out of the way before attempting to insert the module into the socket.

! **IMPORTANT**

If more than one module is to be connected in series with the Q.station X, then ensure that two long black plastic inserts are installed on the right side of each module prior to inserting them into their respective sockets. The black plastic inserts provide guidance for the following module to be inserted.

Carefully guide the module onto the black plastic inserts on the right side of the Q.station X. The module should be gently guided into the socket along the black plastic inserts. Ensure that the module sits flat on the socket once fully inserted. Then tighten the long front-facing screws to lock the module in place.

To remove a module from the socket, first unscrew the front-facing screws (Step 1a) until they can be pulled out from the socket (Step 1b), however, *do not* attempt to completely pull out the screws as they are fixed to the module. *Do not* apply a load to the long screws, especially if fully extended as they can break easily. Once the module is no longer secured to the socket, simply pull out the module along the black plastic inserts (Step 2). Refer to Fig. 5-7 for a graphical representation of the steps for removal.

i **Tip**

Be careful when removing modules as black plastic inserts can fall out from the exposed end.

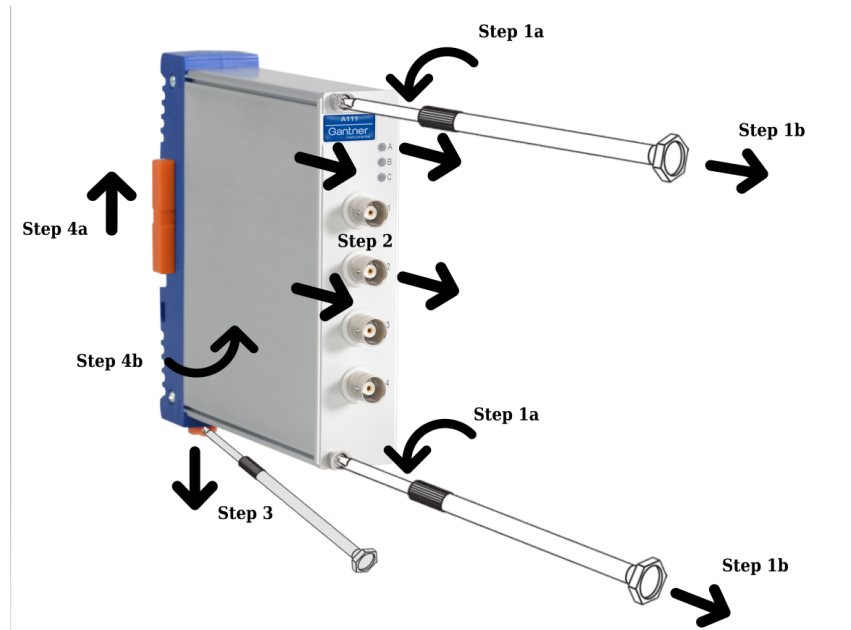

Fig. 5-7 Steps for removing Q.bloxx X module from a socket (Steps 1+2) and removing sockets from rail (Steps 3+4)

Modules can only be removed in the reverse order that they were installed, i.e., modules must be removed from right to left and in sequence in order to remove any desired module in that series as the black plastic inserts also secures system assembly laterally.

To remove a socket with limited clearance, you may use a narrow screwdriver to pull down on the orange tab on the bottom of the socket (Step 3 in Fig. 5-7). At this point, the socket is only hanging on the rail and can be removed by slightly lifting the socket off the rail (Steps 4a + 4b in Fig. 5-7).

i Tip

With great care, entire systems can be lifted off rail if all orange tabs are unlocked, however this method can invite unnecessary risk to both the system (especially if large) and personnel. It is always recommended to fully assemble and disassemble systems directly on mounting rail.

5.5 Q.series XL Modules and Connection Details

5.5.1 Connecting Q.station Classic and Q.series XL Modules

Q.series XL modules are compatible with all versions of Q.series Q.station controllers, e.g., Q.series XL modules can be connected to a Q.station Classic controller. To do this, the Q.series XL modules must be connected to the Q.station Classic via a Q.bloxx-X Socket Left and a shielded twisted pair configuration.

Use Fig. 5-6, page 45, Pin assignments for the Q.bloxx X Extension Socket (QXES); also shown, alternative form factor with module casing (right) as a reference for the wiring configuration. Install a shielded twisted pair between the numbered RS485 A/B lines on the QXES and the numbered A/B pins on the bottom of the Q.station Classic for each UART within that setup.

Recommended specifications for the shielded twisted pair:

- Wire gage: 0.34 mm² or AWG 22
- Resistance at max 110
- Capacity at least 30 pF per meter
- Impedance from 35 to 165 Ω at frequencies from 3 to 20 MHz

5.5.2 Q.series and Q.series XL Sample Rate Limitations

The performance limitations of a Q.series or Q.series XL system directly correlates to the setup structure of the system itself. While Q.series and Q.series XL systems are capable of collecting data at 100kHz per channel, doing so also limits the maximum quantity of channels a UART can support in order to satisfy the required transfer of high-speed data.

For a UART to support multiple channels at 100kHz, the base communication time of the UART must be lower than 90% of 10μs. This requirement limits the maximum quantity of channels that can exist on a UART. All sampling rates have the 90% threshold requirement but the value changes, e.g., 20μs at 50kHz.

For Q.series, a UART can only support 2 channels of 100kHz data for a total of 8 channels at 100kHz per Q.station Classic. For Q.series XL, a UART can support up to 4 channels of 100kHz data for a total of 16 channels at 100kHz per Q.station X. GI.bench will always warn the user if the base communication time of a UART exceeds the required 90% threshold.

5.5.3

Overview of Q.series XL Measurement Modules

Modules:	A 101	A 102	A 103	A 104	A 105	A 106	A 107	A 108	A 109	A 111	A 116
Signal inputs											
Voltage	X	X	X	X			X	X		X	
Current	X	X	X				X	X			
Potentiometer	X						X				
Resistance	X				X		X				
Pt100, Pt1000	X				X		X				
Thermocouple	X			X			X				
Strain gage full + half bridge	X	X				X	X ¹⁾				X
Strain gage quarter bridge	X ²⁾	X ²⁾				X ²⁾	X ²⁾				X
Inductive full + half bridge						X					
LVDT, RVDT						X					
IEPE/ICP [®] Sensor	X	X								X	
Piezoelectric Sensor											
Optical Sensor											
Digital input: frequency, pulse width, counter									X		
Digital input: Status	X	X	X			X		X	X		
Signal outputs											
Voltage		X				X			X		
Current		X							X		
Digital output: frequency, pulse width									X		
Digital output: Status	X	X	X			X		X	X		
Number of channels	2	1	8	8	4	2	4	8	4	4	8
Data rate (in Hz)	100k	100k	100	100	10	20k	20k	20k	100k	100k	20k
For description refer to page	53	58	62	64	66	68	72	77	79	81	83

1) Half bridge only with special Terminal

2) Quarter bridge with special Terminal

3) Temperature, strain, pressure, acceleration, vibration, or displacement optical sensors

Modules:	A 121	A 123	A 124	A 127	A 128	A 141	A 146	F 108	D 101	D 104	D 105	D 107
Signal inputs												
Voltage	X	X	X	X	X							
Current	X											
Potentiometer	X											
Resistance	X											
Pt100, Pt1000	X											
Thermocouple			X									
Strain gages full + half bridge	X											
Strain gage quarter bridge							X					
Inductive full + half bridge												
LVDT, RVDT												
IEPE/ICP [®] Sensor	X											
Piezoelectric Sensor						X						
Optical Sensor								X ³⁾				
Digital input: frequency, pulse width, counter									X			X
Digital input: Status									X	X		X
Signal outputs												
Voltage												
Current												
Digital output: frequency, pulse width									X			
Digital output: Status									X		X	
Number of channels	2	4	4	4	4	4	16	up to 8	8	16	16	6
Data rate (in Hz)	up to 100k	100k	20k	100k	100k	100k	10k	up to 50k	up to 100k	100k	100k	1M
For description refer to page	93	96	98	100	103	105	106	N/A	112	114	115	116

5.6

Q.series XL A101: Connecting Sensors and I/O

The Q.series XL A101 has two electrically isolated analog inputs and two digital inputs or outputs. The pin assignments of the two blue connector strips below are identical. Connection terminals are associated to numbers to help in identifying connections.

The designation GND identifies the measurement ground of an input while 0 V and +V designate the (external) supply voltage connections. Measurement ground and (external) supply voltage are electrically isolated in the module.

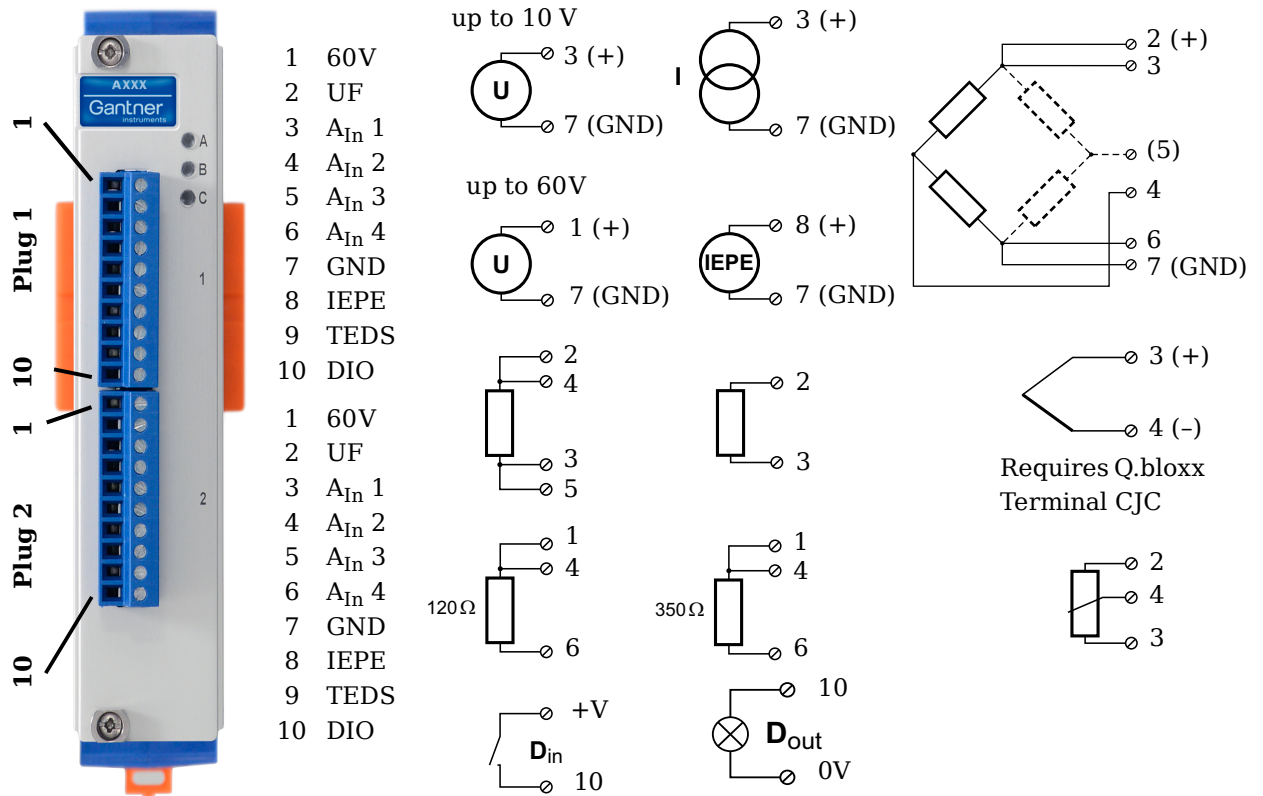

Fig. 5-8 Pin assignments for Q.series XL A101

i Tip
For additional information regarding functional procedures for various measurements, refer to Chapter 11 on page 211.

5.6.1

Voltage

For voltage measurements, two connection variants are available depending on the level of voltages to be measured: up to ±10V & up to ±60V. You can specify the data range you wish to use while configuring the channel using *GI.bench* (**Hardware defined** or **Maximum** and **Minimum** fields in *Value handling* settings).

! **IMPORTANT**

Attempting to measure voltages which exceed the admissible limitations will produce incorrect measurement data as inputs are protected against overvoltage and will therefore limit the input voltage to prevent damage.

Voltages up to 10V

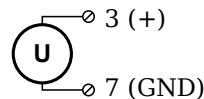

Voltages up to 60V

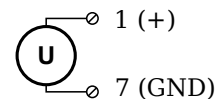

Fig. 5-9 A101, terminal wiring configuration for measurement of voltage

5.6.2

Current

For current measurements, an internal shunt resistance of 50Ω is integrated into the Q.series X A101 module. The internal shunt resistor will facilitate the measurement of currents up to 25mA. For current measurements higher than 25mA, configure the channel for voltage measurement and use an external shunt resistance terminal. The external shunt resistance terminal can be obtained under the designation *Q.bloxx Terminal SR* from Gantner Instruments or your domestic Gantner Instruments Sales and Service location; refer to Section 11.5, page 221.

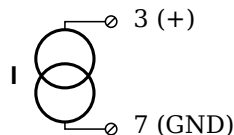

Fig. 5-10 A101, terminal wiring configuration for measurement of current, *Q.bloxx Terminal SR* necessary for signals exceeding 25mA

5.6.3

Potentiometer

For potentiometer measurements, resistances between 1k Ω and 10k Ω can be connected using a three-wire configuration.

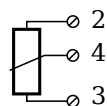

Fig. 5-11 A101, terminal wiring configuration for measurement with potentiometers

5.6.4

Resistance, Pt100, Pt1000

For resistance type and RTD (Pt100/1000) measurements, you may connect sensors using either a two-wire or four-wire configuration. You can specify the type of configuration you wish to use while configuring the channel within *GI.bench* (**Analog input type** in *General* settings).

2-wire circuit

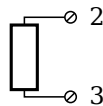

4-wire circuit

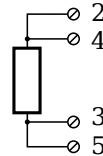

Fig. 5-12 A101, terminal wiring configuration for measurement with resistance type and Pt100/1000 probes

i Tip

Information regarding transducers and cables with sensing leads can be found in Chapter 11.2 on page 214.

5.6.5

Thermocouple

For thermocouple measurements with *internal* cold junction compensation, you will need to use special cold junction compensation (CJC) terminals which will provide the necessary comparative measuring point for accurate measurement. CJC terminals can be obtained under the designation *Q.bloxx Terminal CJC-A101* from Gantner Instruments or your domestic Gantner Instruments Sales and Service location.

Alternatively, for thermocouple measurements with *external* cold junction compensation, you can use two thermocouples per temperature measurement or a reference temperature source.

You may connect the following types of thermocouples to the Q.series XL A101 module: B, E, J, K, L, N, R, S, T and U.

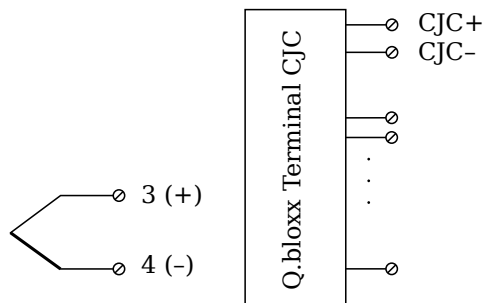

Fig. 5-13 A101, terminal wiring configuration for measurement with thermocouple using *Q.bloxx Terminal CJC-A101*

i Tip

You can find additional information regarding the necessity of a comparative measuring point for thermocouple measurements as well as additional information on thermocouple measurements with a reference temperature source in Section 11.6, *Measurements with Thermocouples*, page 222

5.6.6

Full and Half-bridge Transducer

For resistive *full bridge* (strain gage) measurements, all connections to the Q.series XL A101 terminal shown in the diagram below are necessary. If you are not utilizing a sensor with sensing leads, you must specify this during module configuration in *GI.bench* (**Analog input type** in *General* settings). In this case, inputs 3 and 6 remain open in the diagram below.

For resistive *half bridge* (strain gage) measurements, the dotted sides and connection 5 shown in the diagram below are omitted. The bridge excitation voltage provided by Q.series XL A101 modules is 2.5V.

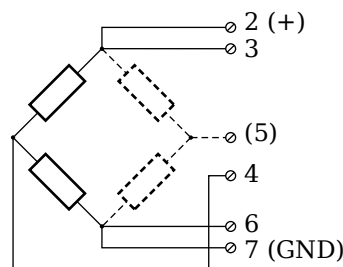

Fig. 5-14 A101, terminal wiring configurations for measurement with full and half bridges

i Tip

Information regarding transducers and cables with sensing leads can be found in Chapter 11.2 on page 214.

5.6.7

Quarter-bridge Strain Gage

For resistive *quarter bridge* (strain gage) measurements, you will need a special bridge completion terminal which will provide the necessary bridge completion resistance; 120Ω or 350Ω. The bridge completion terminal can be obtained under the designation *Q.bloxx Terminal B4/120-A101* for 120Ω completion or *Q.bloxx Terminal B4/350-A101* for 350Ω completion from Gantner Instruments or your domestic Gantner Instruments Sales and Service location.

The bridge excitation voltage provided by Q.series XL A101 modules is 2.5V.

! IMPORTANT

The bridge completion terminals used must have the same resistance values as the strain gages used for measurement. All the necessary completion resistances are located within the *Q.bloxx Terminal B4/120-A101* or *Q.bloxx Terminal B4/350-A101* provided by Gantner Instruments. For all channel configurations where these terminals are used, in *GI.bench*, you must select **Bridge, Resistive Full (4- or 6-Wire)** as **Analog input type**.

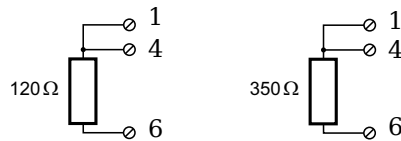

Fig. 5-15 A101, terminal wiring configurations for measurement with strain gage quarter bridge using either *Q.bloxx Terminal B4/120-A101* or *Q.bloxx Terminal B4/350-A101*

5.6.8

IEPE/ICP®

For IEPE/ICP® measurements, the connected sensor is provided a current supply of 4.5mA from the Q.series XL A101 module.

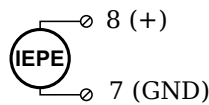

Fig. 5-16 A101, terminal wiring configuration for measurement with IEPE or ICP® sensors

5.6.9

Digital Input and Output

On each Q.series XL A101 terminal, a single contact is available for use as either a digital input or digital output. You can use the appropriate function depending on the terminal wiring configurations shown in the following diagram.



Fig. 5-17 A101, terminal wiring configurations for digital input and output

The digital input is active (high level) when the applied voltage signal exceeds the threshold of 10V.

5.7

Q.series XL A102: Connecting Sensors and I/O

The Q.series XL A102 has one analog input, one analog output, four digital inputs, and two digital outputs, and each electrically isolated from one another. The pin assignments for the connector strips on are *not* identical. The connection terminals have numbers for identifying connections.

The designation GND identifies the measurement ground of an input while 0V and +V designate the (external) supply voltage connections. Measurement ground and (external) supply voltage are electrically isolated in the module.

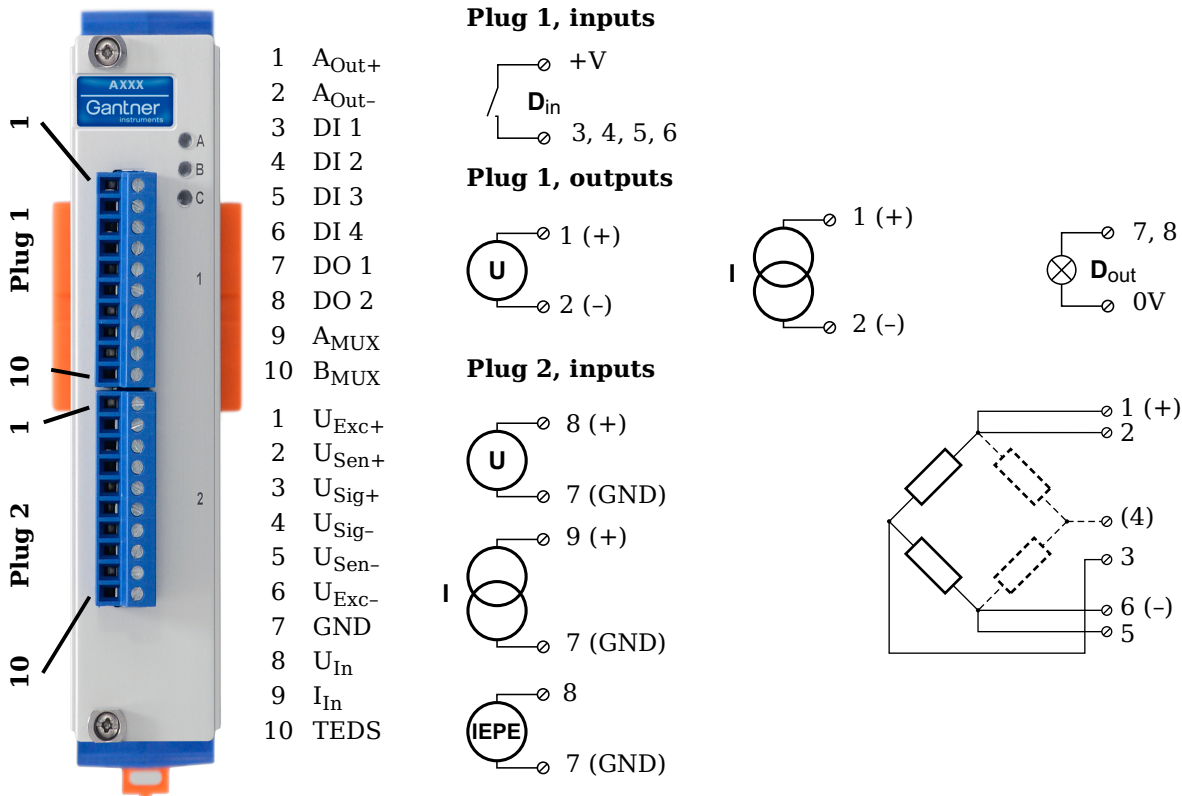

Fig. 5-18 Pin assignments for Q.series XL A102

5.7.1

Voltage

For voltage measurements, you can connect signals of up to ±10V via Terminal 2.

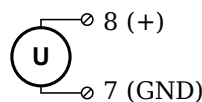

Fig. 5-19 A102, terminal wiring configuration for measurement of voltage, available via Terminal 2.

! IMPORTANT

Attempting to measure voltages which exceed the admissible limitations will produce incorrect measurement data as inputs are protected against overvoltage and will therefore limit the input voltage to prevent damage.

5.7.2**Current**

For current measurements, an internal shunt resistance of 50Ω is integrated into the Q.series XL A102 module. The internal shunt resistor will facilitate the measurement of currents of up to 25 mA via Terminal 2. For current measurements higher than 25 mA, configure the module for voltage measurement and use an external shunt resistance terminal. The external shunt resistance terminal can be obtained under the designation *Q.bloxx Terminal SR* from Gantner Instruments or your domestic Gantner Instruments Sales and Service location; refer to Section 11.5, page 221.

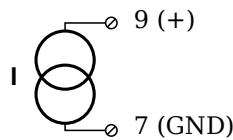

Fig. 5-20 A102, terminal wiring configuration for measurement of current, *Q.bloxx Terminal SR* necessary for signals exceeding 25 mA, available via Terminal 2 only

5.7.3**Full and Half-bridge Transducer**

For resistive *full bridge* (strain gage) measurements, all connections to the Q.series XL A102 terminal shown in the diagram below are necessary. If you are not utilizing a sensor with sensing leads, you must specify this during module configuration in *GI.bench* (**Analog input type** in *General* settings). In this case, inputs 2 and 5 remain open in the diagram below.

For resistive *half bridge* (strain gage) measurements, the dotted sides and connection 4 shown in the diagram below are omitted. The bridge excitation voltage provided by Q.series XL A102 modules is configurable via *GI.bench* between 1V, 2.5V, 5V and 10V.

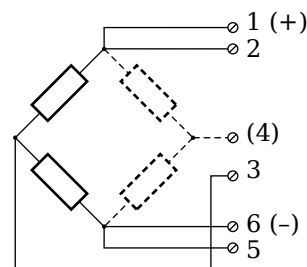

Fig. 5-21 A102, terminal wiring configurations for measurement with full and half bridges, available via Terminal 2 only

i Tip

Information regarding transducers and cables with sensing leads can be found in Chapter 11.2 on page 214.

5.7.4

Quarter-bridge Strain Gage

For resistive *quarter bridge* (strain gage) measurements, you will need a special bridge completion terminal which will provide the necessary bridge completion resistance; 120Ω or 350Ω. The bridge completion terminal can be obtained under the designation *Q.bloxx Terminal B4/120-A102* for 120Ω completion or *Q.bloxx Terminal B4/350-A102* for 350Ω completion from Gantner Instruments or your domestic Gantner Instruments Sales and Service location.

The bridge excitation voltage provided by Q.series XL A102 modules is configurable via *GI.bench* between 1V, 2.5V, 5V and 10V.

! IMPORTANT

The bridge completion terminals used must have the same resistance values as the strain gages used for measurement. All the necessary completion resistances are located within the *Q.bloxx Terminal B4/120-A102* or *Q.bloxx Terminal B4/350-A102* provided by Gantner Instruments. For all channel configurations where these terminals are used, in *GI.bench*, you must select **Bridge, Resistive Full (4- or 6-Wire)** as **Analog input type**.

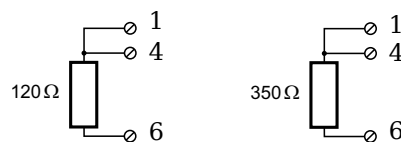

Fig. 5-22 A102, terminal wiring configurations for measurement with strain gage quarter bridge using either *Q.bloxx Terminal B4/120-A102* or *Q.bloxx Terminal B4/350-A102*, available via Terminal 2 only

5.7.5

IEPE/ICP®

For IEPE/ICP® measurements, the connected sensor is provided a current supply of 4.5 mA from the Q.series XL A102 module. Such measurements are only available via Terminal 2.

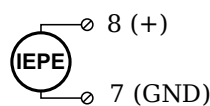

Fig. 5-23 A102, terminal wiring configuration for measurement with IEPE or ICP® sensors, available via Terminal 2 only

5.7.6

Analog Output

For analog output, two output configurations are available to you via Terminal 1 only: voltage or current. Select the preferred output variant in *GI.bench* (**Analog output type** field in *General* settings).

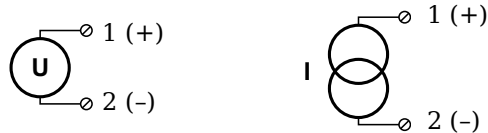

Fig. 5-24 A102, terminal wiring configuration for analog output of voltage or current, available via Terminal 1 only

5.7.7

Digital Input and Output

On Terminal 1 of the Q.series XL A102, contacts are available for four digital inputs and two digital outputs. You can use the appropriate function(s) depending on the terminal wiring configurations shown in the following diagram.

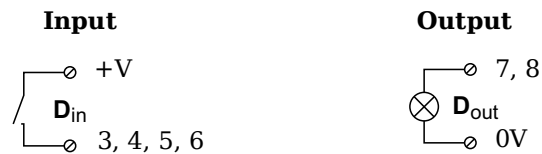

Fig. 5-25 A102, terminal wiring configurations for digital input and output, available via Terminal 1 only

The digital input is active (high level) when the applied voltage signal exceeds the threshold of 10V.

5.8

Q.series XL A103: Connecting Sensors and I/O

The Q.series XL A103 has eight electrically isolated analog inputs and two digital inputs and outputs. The pin assignments of the two blue connector strips below are identical. Connection terminals are associated to numbers to help in identifying connections. The designation GND identifies the measurement ground of an input while 0V and +V designate the (external) supply voltage connections. Measurement ground and (external) supply voltage are electrically isolated in the module.

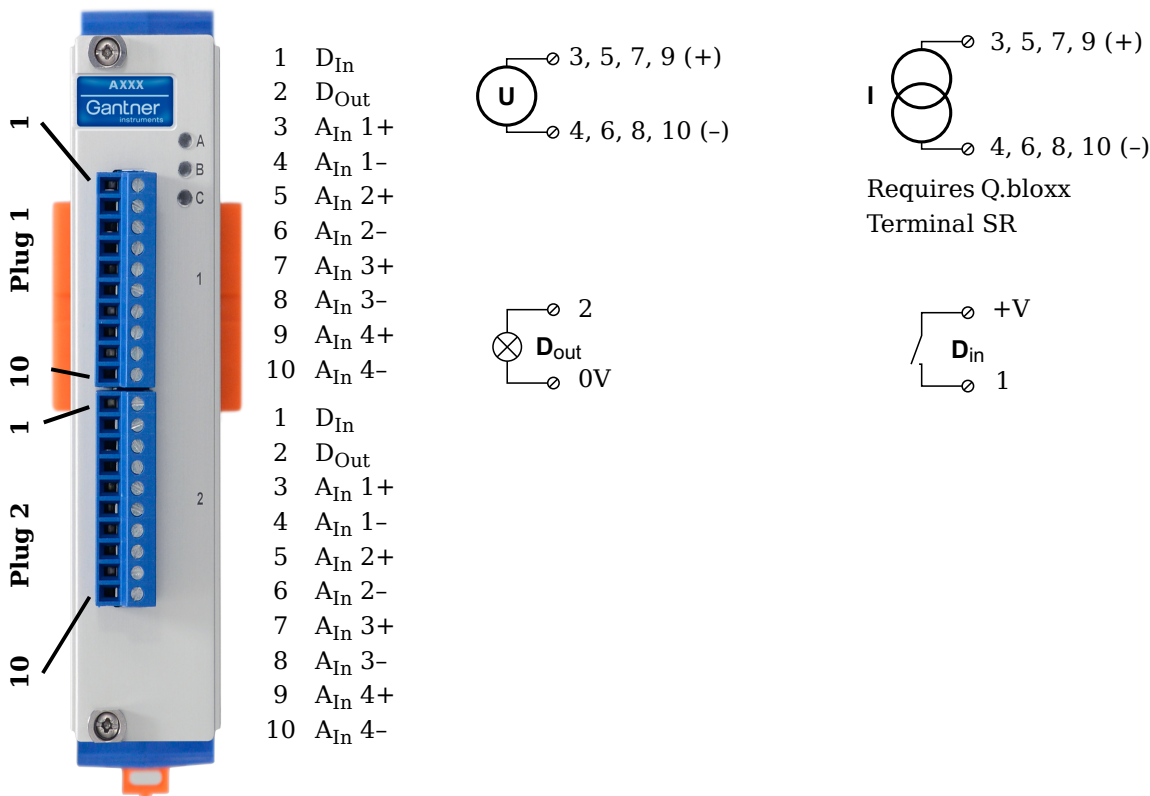

Fig. 5-26 Pin assignments for Q.series XL A103

i Tip

Information regarding transducers and cables with sensing leads can be found in Chapter 11.2 on page 214.

5.8.1

Voltage

For voltage measurements, you can connect signals of up to $\pm 10V$.

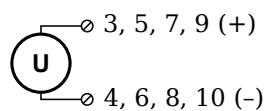

Fig. 5-27 A103, terminal wiring configuration for measurement of voltage

! IMPORTANT

Attempting to measure voltages which exceed the admissible limitations will produce incorrect measurement data as inputs are protected against overvoltage and will therefore limit the input voltage to prevent damage.

5.8.2**Current**

For current measurements, an external shunt resistance terminal is needed. The external shunt resistance terminal is obtained under the designation *Q.bloxx Terminal SR* from Gantner Instruments or your domestic Gantner Instruments Sales and Service location. The *Q.bloxx Terminal SR* facilitates the measurement of currents up to 25mA for the Q.series XL A103 module.

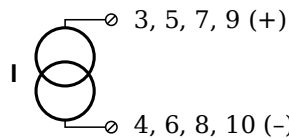

Fig. 5-28 A103, terminal wiring configurations for measurement of current using the *Q.bloxx Terminal SR*

5.8.3**Digital Input and Output**

On each Q.series XL A103 terminal, there are two contacts available for a digital input and digital output. You can use the appropriate function(s) depending on the terminal wiring configurations shown in the following diagram.



Fig. 5-29 A103, terminal wiring configurations for digital input and output

The digital input is active (high level) when the applied voltage signal exceeds the threshold of 10V.

5.9

Q.series XL A104 TCK: Connecting sensors

The Q.series XL A104 has eight electrically isolated analog inputs for thermocouples or voltages. The pin assignments of the two blue connector strips below are identical. Connection terminals are associated to numbers to help in identifying connections. A TCK variant of the Q.series XL A104 is also available (Fig. 5-30). Measurement ground and (external) supply voltage are electrically isolated within the module.

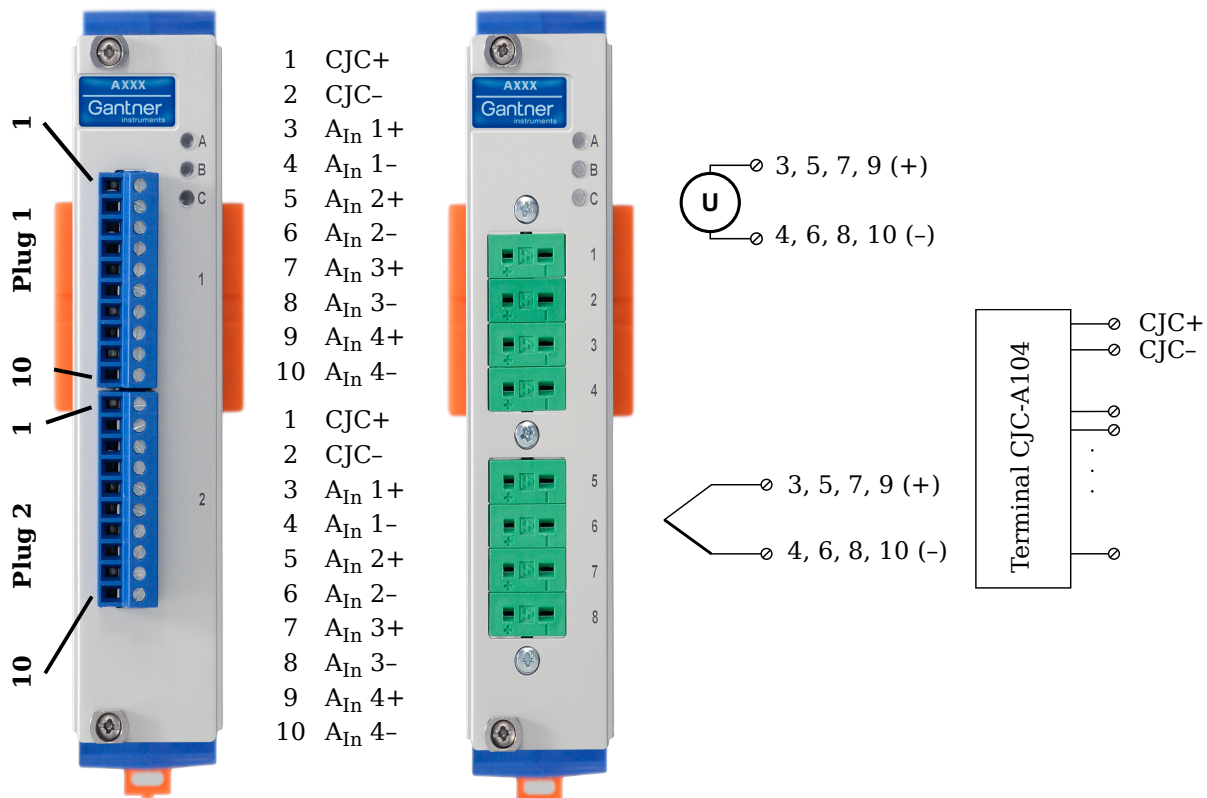

Fig. 5-30 Pin assignments for Q.series XL A104 and TCK variant

i **Tip**

Information regarding measuring with thermocouples can be found in Chapter 11.6 on page 222.

5.9.1

Voltage

For voltage measurements, you can connect signals of up to ±80mV.

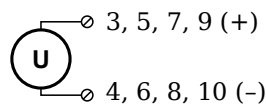

Fig. 5-31 A104, terminal wiring configurations for measurement of voltage

! IMPORTANT

Attempting to measure voltages which exceed the admissible limitations will produce incorrect measurement data as inputs are protected against overvoltage and will therefore limit the input voltage to prevent damage.

5.9.2

Thermocouple

For thermocouple measurements with *internal* cold junction compensation, you will need to use special cold junction compensation (CJC) terminals which will provide the necessary comparative measuring point for accurate measurement. The CJC terminals can be obtained under the designation *Q.bloxx Terminal CJC-A104* from Gantner Instruments or your domestic Gantner Instruments Sales and Service location. The TCK variant of the Q.series XL A104 module does not require the *Q.bloxx Terminal CJC-A104* for temperature measurements.

Alternatively, for thermocouple measurements with *external* cold junction compensation, you can also use two thermocouples per temperature measurement or a reference temperature source.

You may connect the following types of thermocouples to the Q.series XL A101 module: B, E, J, K, L, N, R, S, T and U.

i Tip

You can find additional information regarding the necessity of a comparative measuring point for thermocouple measurements as well as additional information on thermocouple measurements with a reference temperature source in.

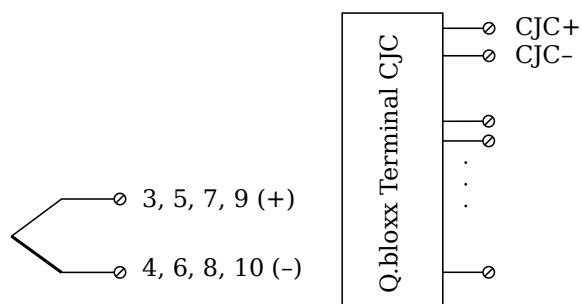

Fig. 5-32 A104, terminal wiring configurations for measurement with thermocouples using *Q.bloxx Terminal CJC-A104*

5.10

Q.series XL A105: Connecting Sensors

The Q.series XL A105 has four electrically isolated analog inputs. The pin assignments of the two blue connector strips below are identical. Connection terminals are associated to numbers to help in identifying connections.

The designation GND identifies the measurement ground of an input. Measurement ground and (external) supply voltage are electrically isolated in the module.

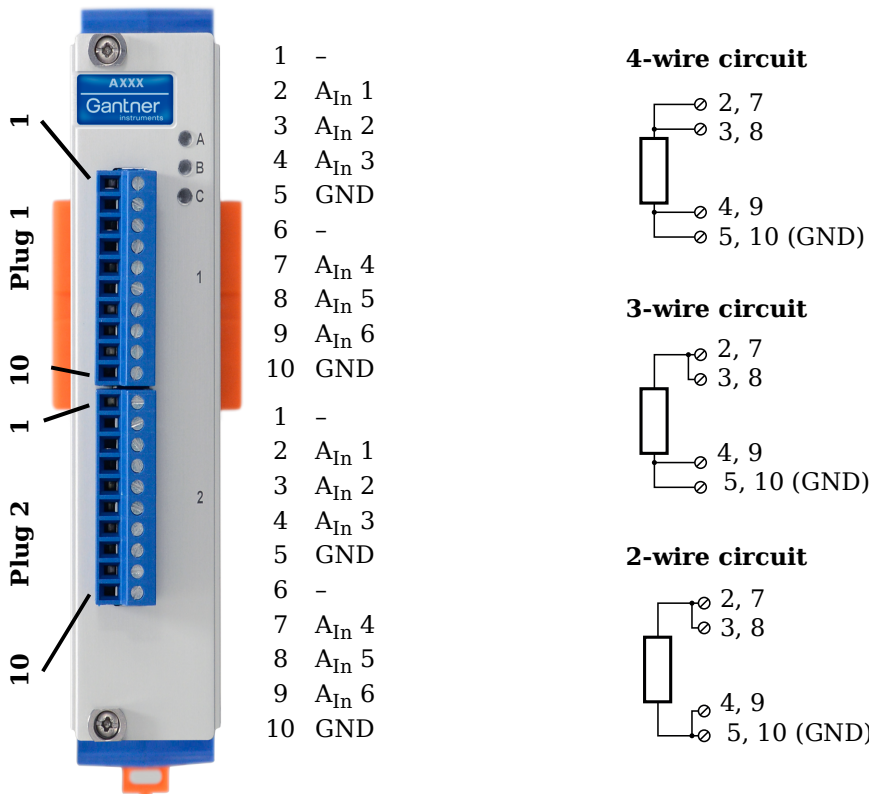

Fig. 5-33 Pin assignments for Q.series XL A105

i Tip

For additional information regarding functional procedures for various measurements, refer to Chapter 11 on page 211.

5.10.1

Resistance, Pt100, Pt1000

For resistance type and RTD (Pt100/1000) measurements, you may connect sensors using either a two-wire, three-wire or four-wire configuration. You can specify the type of configuration you wish to use while configuring the channel within *GI.bench* (**Analog input type** in settings).

In addition to configuring the channel in *GI.bench*, you must also ensure for each configuration type that all terminations are connected (i.e. for two- and three-wire configurations, unused terminations must be bridged).

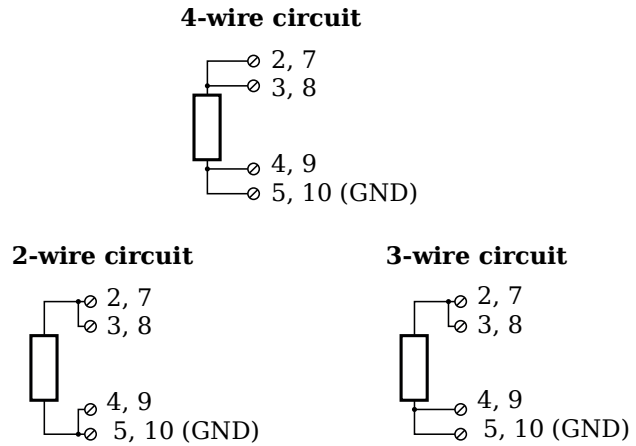

Fig. 5-34 A105, terminal wiring configurations for measurement with resistance and Pt100/1000 probes

i Tip

For additional important information regarding using resistive type transducer measurements, see Section 11.2, page 214.

5.11

Q.series XL A106: Connecting Sensors and I/O

The Q.series XL A106 has two electrically isolated analog inputs, two analog outputs and a total of four digital inputs or outputs. The pin assignments of the two connector strips are identical and the connection terminals have numbers for identifying connections.

The designation GND identifies the ground for the analog output while 0 V and +V designate the (external) supply voltage connections. The ground and (external) supply voltage connections are electrically isolated in the module.

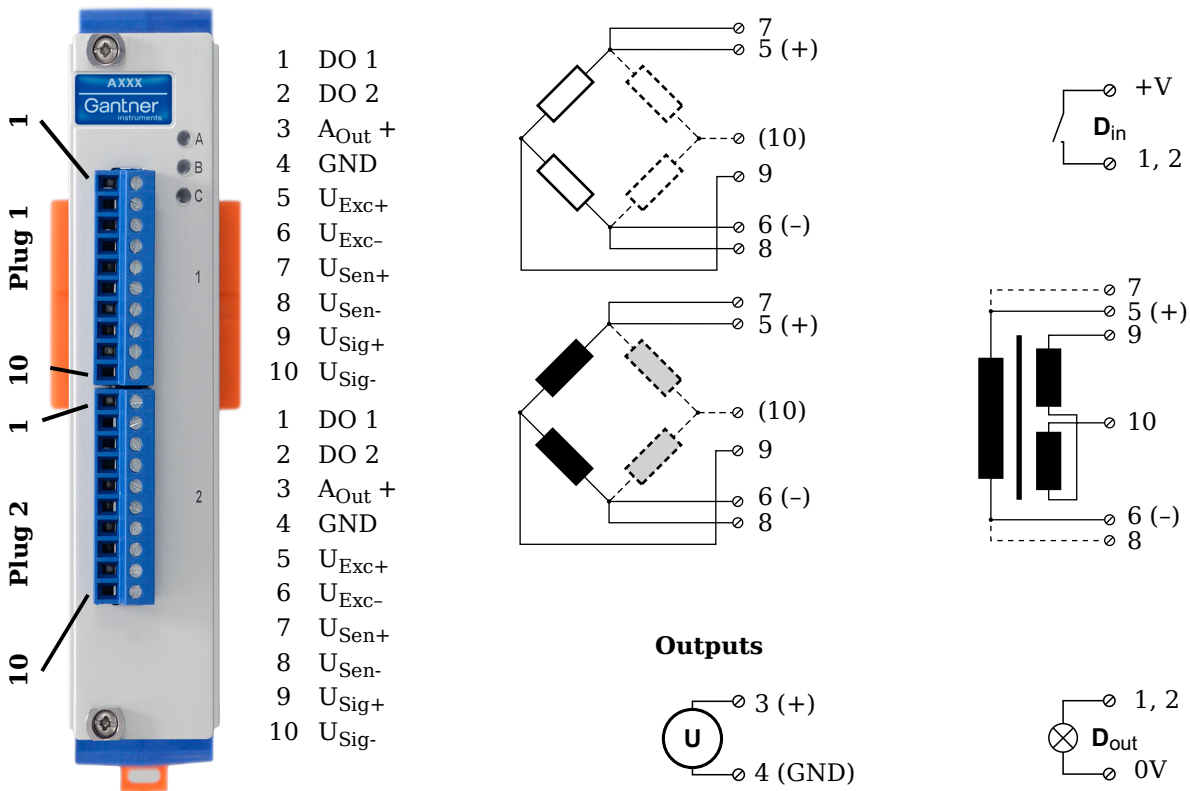

Fig. 5-35 Pin assignment for Q.series XL Module A106

i Tip

For additional information regarding functional procedures for various measurements, refer to Chapter 11 on page 211.

5.11.1

Full and Half-bridge Transducer

For resistive *full bridge* (strain gage) measurements, all connections to the Q.series XL A106 terminal shown in the diagram below are necessary. If you are not utilizing a sensor with sensing leads, you must specify this during module configuration in *GI.bench* (**Analog input type** in settings). In this case, inputs 7 and 8 remain open in the diagram below.

For resistive *half bridge* (strain gage) measurements, the dotted sides and connection 10 shown in the diagram below are omitted. The bridge excitation voltage provided by the Q.series XL A106 module can be either 2.5V or 5V (DC or CF). In *GI.bench*, you can specify the supply voltage and carrier frequency in the **Sensor** and **Analog input type** fields in *Variable settings*, respectively.

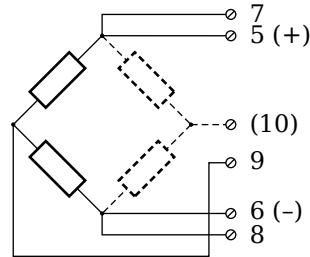

Fig. 5-36 A106, terminal wiring configurations for measurement with full and half bridges

i Tip

For additional important information regarding using resistive type transducer measurements, see Section 11.2, page 214.

5.11.2

Quarter-bridge Strain Gage

For resistive quarter bridge (strain gage) measurements, you will need a special bridge completion terminal which will provide the necessary bridge completion resistance; 120Ω or 350Ω. The bridge completion terminal can be obtained under the designation *Q.bloxx Terminal B4/120-A106* for 120Ω completion or *Q.bloxx Terminal B4/350-A106* for 350Ω completion from Gantner Instruments or your domestic Gantner Instruments Sales and Service location.

The bridge excitation voltage provided by the Q.series XL A106 module can be either 2.5V or 5V (DC or CF). In *GI.bench*, you can specify the supply voltage and carrier frequency in the **Sensor** and **Analog input type** fields in *Variable settings*, respectively.

! IMPORTANT

The bridge completion terminals used must have the same resistance values as the strain gages used for measurement. All the necessary completion resistances are located within the *Q.bloxx Terminal B4/120-A106* or *Q.bloxx Terminal B4/350-A106* provided by Gantner Instruments. Due to this, in *GI.bench*, select *Bridge, Resistive Half (3- or 5-Wire)* as the **Analog input type** for all channel configurations where these terminals are used.

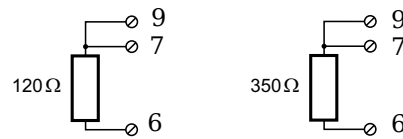

Fig. 5-37 A106, terminal wiring configurations for measurement with strain gage quarter bridge using either Q.bloxx Terminal B4/120-A106 or Q.bloxx Terminal B4/350-A106

5.11.3

Inductive Full and Half-bridge Transducer

For inductive *full bridge* (strain gage) measurements, all connections to the Q.series XL A106 module shown in the diagram below are necessary. If you are not utilizing a sensor with sensing leads, you must specify this during module configuration in *GI.bench* (**Analog input type** in settings).

For resistive *half bridge* (strain gage) measurements, the dotted sides and connection 10 in the diagram shown below are omitted. The bridge excitation voltage provided by the Q.series XL A106 module can be either 2.5V or 5V. In *GI.bench*, you can specify the supply voltage in the **Sensor** field in *Variable settings*.

! IMPORTANT

Inductive sensors can only be configured as **CF 4800Hz** (carrier frequency) for the **Analog input type** field in *Variable settings* in *GI.bench*. This is because inductive sensors cannot operate using direct voltage (DC) or a 600Hz carrier frequency.

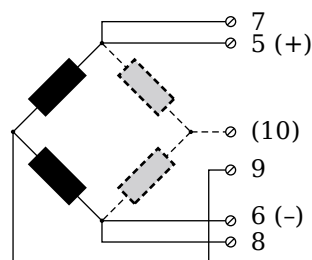

Fig. 5-38 A106, terminal wiring configurations for measurement with inductive full and half bridges

5.11.4

LVDT, RVDT

For inductive LVDT or RVDT measurements, sensor connections to the Q.series XL A106 module are shown in the diagram below. If you are not utilizing a sensor with sensing leads, you must specify this during module configuration in *GI.bench* (**Analog input type** in settings).

The bridge excitation voltage provided by the Q.series XL A106 module can be either 2.5V or 5V. In *GI.bench*, you can specify the supply voltage in the **Sensor** field in *Variable settings*.

! IMPORTANT

Inductive sensors can only be configured as **CF 4800Hz** (carrier frequency) for the **Analog input type** field in *Variable settings* in *GI.bench*. This is because inductive sensors cannot operate using direct voltage (DC) or a 600Hz carrier frequency.

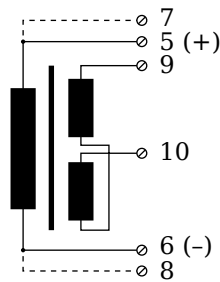

Fig. 5-39 A106, terminal wiring configurations for measurement with LVDT and RVDT

5.11.5

Analog Output

For analog output, both terminals are capable of analog voltage output. Select the preferred output terminal in *GI.bench* (**Terminal** field in *Variable settings*).

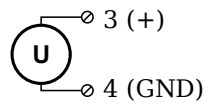

Fig. 5-40 A106, terminal wiring configuration for analog voltage output

5.11.6

Digital Input and Output

On each Q.series XL A106 terminal, there are two contacts available for either a digital input or digital output. You can use the appropriate function(s) depending on the terminal wiring configurations shown in the following diagram.



Fig. 5-41 A106, terminal wiring configurations for digital input and output

The digital input is active (high level) when the applied voltage signal exceeds the threshold of 10V.

5.12

Q.series XL A107: Connecting Sensors

The Q.series XL A107 has four electrically isolated analog inputs. The pin assignment of the two connector strips is identical and the connection terminals have numbers for identifying the connections.

The designation GND identifies the measurement ground of an input. The four inputs (UF to GND) and (external) supply voltage are also electrically isolated from each other in the module.

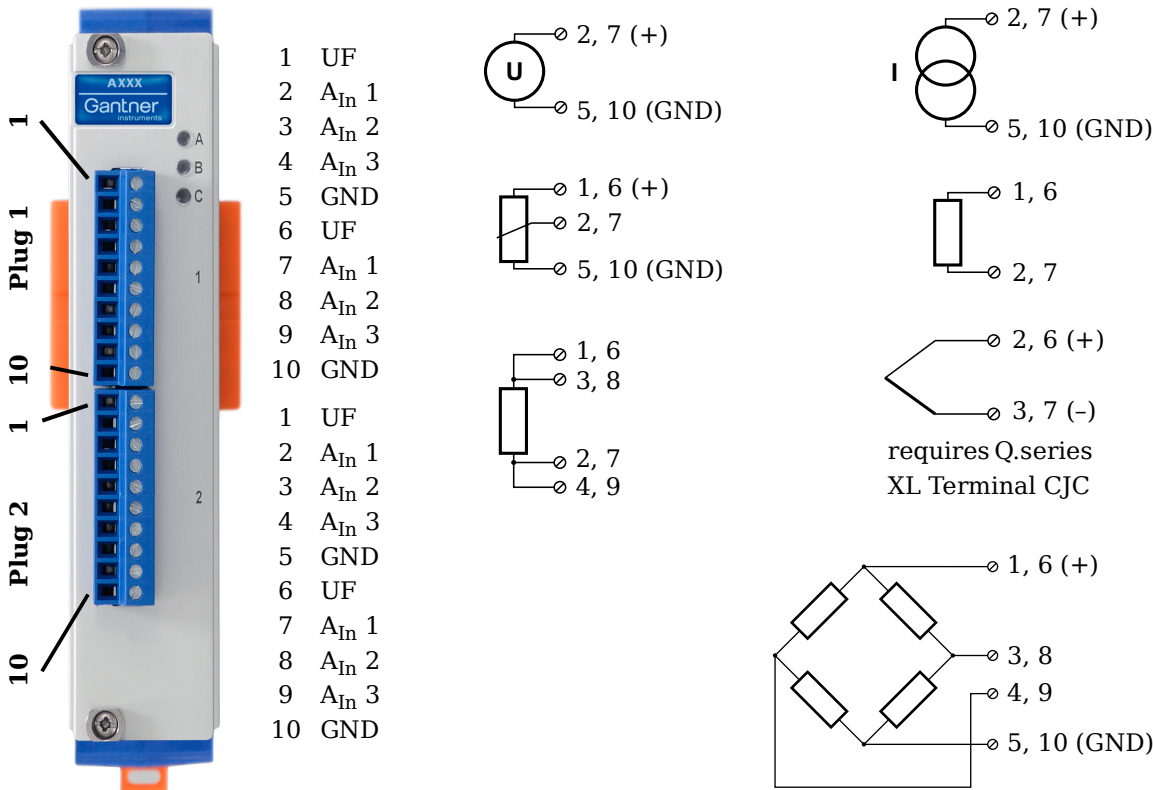

Fig. 5-42 Pin assignments for Q.series XL A107

i Tip

For additional information regarding functional procedures for various measurements, refer to Chapter 11 on page 211.

5.12.1

Voltage

For voltage measurements, you can connect signals of up to ±10V.

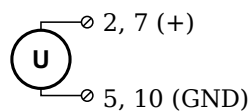

Fig. 5-43 A107, terminal wiring configurations for measurement of voltage

! IMPORTANT

Attempting to measure voltages which exceed the admissible limitations will produce incorrect measurement data as inputs are protected against overvoltage and will therefore limit the input voltage to prevent damage.

5.12.2**Current**

For current measurements, an internal shunt resistance of 50Ω is integrated into the Q.series X A107 module. The internal shunt resistor will facilitate the measurement of currents of up to 25mA. For current measurements higher than 25mA, configure the module for voltage measurement and use an external shunt resistance terminal. The external shunt resistance terminal can be obtained under the designation *Q.bloxx Terminal SR* from Gantner Instruments or your domestic Gantner Instruments Sales and Service location; refer to Section 11.5, *Current Measurements with External Shunt*, page 221.

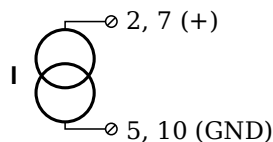

Fig. 5-44 A107, terminal wiring configurations for measurement of current, *Q.bloxx Terminal SR* necessary for signals exceeding 25mA

5.12.3**Potentiometer**

For potentiometer measurements, resistances between 1k Ω and 10k Ω can be connected using a three-wire configuration.

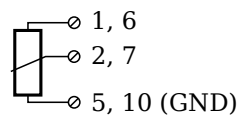
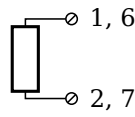

Fig. 5-45 A107, terminal wiring configurations for measurement with potentiometers

5.12.4**Resistance, Pt100, Pt1000**

For resistance type and RTD (Pt100/1000) measurements, you may connect sensors using either a two-wire or four-wire configuration. You can specify the type of configuration you wish to use while configuring the channel within *Gl.bench* (**Analog input type** in settings).

2-wire circuit



4-wire circuit

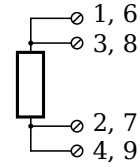

Fig. 5-46 A107, terminal wiring configurations for measurement with resistance and Pt100/1000 probes



Tip

Information about the types of configurations available to you and their respective advantages and disadvantages can be found in Section 11.2, *Connecting Transducers with Sensing Leads*, page 214.

5.12.5

Thermocouple

For thermocouple measurements with *internal* cold junction compensation, you will need to use special cold junction compensation (CJC) terminals which will provide the necessary comparative measuring point for accurate measurement. The CJC terminals can be obtained under the designation *Q.bloxx Terminal CJC-A107* from Gantner Instruments or your domestic Gantner Instruments Sales and Service location. The TCK variant of the Q.series XL A107 module does not require the *Q.bloxx Terminal CJC-A107* for temperature measurements.

Alternatively, for thermocouple measurements with *external* cold junction compensation, you can also use two thermocouples per temperature measurement or a reference temperature source.

You may connect the following types of thermocouples to the Q.series XL A107 module: B, E, J, K, L, N, R, S, T and U.

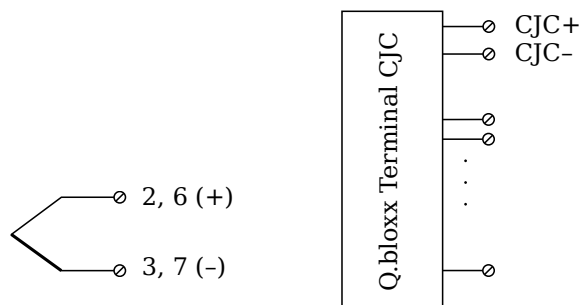

Fig. 5-47 A107, terminal wiring configurations for measurement with thermocouple using *Q.bloxx Terminal CJC-A107*

i Tip

You can find additional information regarding the necessity of a comparative measuring point for thermocouple measurements as well as additional information on thermocouple measurements with a reference temperature source in Section 11.6, *Measurements with Thermocouples*, page 222.

5.12.6**Full-bridge Transducer**

For resistive *full bridge* (strain gage) measurements, the four connections to the Q.series XL A107 terminal shown in the diagram below are necessary. If your sensor has sensing leads, connect them to the relevant supply lines (1 and 5 or 6 and 10).

The bridge excitation voltage provided by the Q.series XL A107 module is 2.5V.

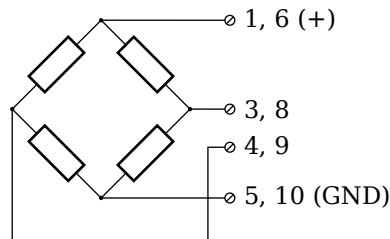

Fig. 5-48 A107, terminal wiring configurations for measurement with full bridges

5.12.7**Half and Quarter-bridge Strain Gage**

For resistive *half* and *quarter* bridge (strain gage) measurements, you will need a special bridge completion terminal which will provide the necessary bridge completion resistance; 120Ω or 350Ω. The bridge completion terminal can be obtained under the designation *Q.bloxx Terminal B4/120-A107* for 120Ω completion or *Q.bloxx Terminal B4/350-A107* for 350Ω completion from Gantner Instruments or your domestic Gantner Instruments Sales and Service location.

The bridge excitation voltage provided by Q.series XL A107 modules is 2.5V.

! IMPORTANT

The bridge completion terminals used must have the same resistance values as the strain gages used for measurement. All the necessary completion resistances are located within the *Q.bloxx Terminal B4/120-A107* or *Q.bloxx Terminal B4/350-A107* provided by Gantner Instruments. Due to this, in *GI.bench*, select *Bridge, Resistive Full (4-Wire)* as the **Analog input type** for all channel configurations where these terminals are used.

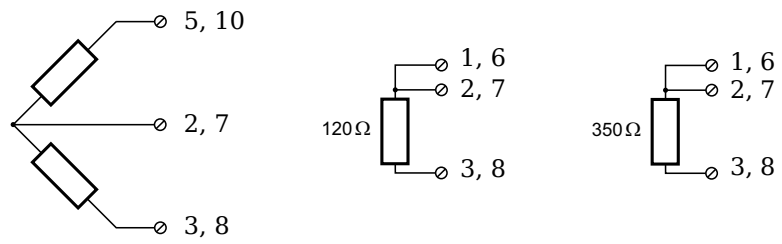

Fig. 5-49 A107, terminal wiring configurations for measurement with strain gage half and quarter bridge using either Q.bloxx Terminal B4/120-A107 or Q.bloxx Terminal B4/350-A107

5.13

Q.series XL A108: Connecting Sensors and I/O

The Q.series XL A108 has eight electrically isolated analog inputs and two digital inputs and outputs. Pin assignments of the two connector strips is identical and the connection terminals have numbers for identifying the connections.

The designations 0 V and +V represent the (external) supply voltage connections. Measurement connections and (external) supply voltage are electrically isolated in the module.

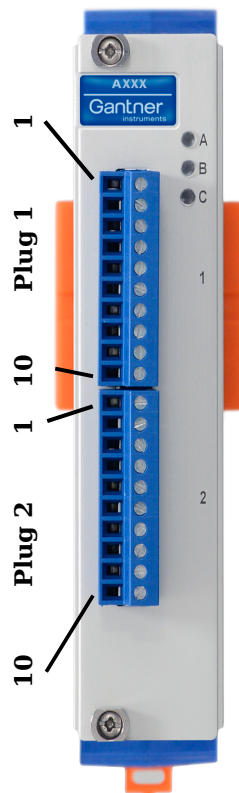

- 1 D_{In}
- 2 D_{Out}
- 3 A_{In} 1+
- 4 A_{In} 1-
- 5 A_{In} 2+
- 6 A_{In} 2-
- 7 A_{In} 3+
- 8 A_{In} 3-
- 9 A_{In} 4+
- 10 A_{In} 4-

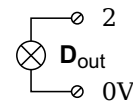
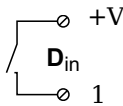
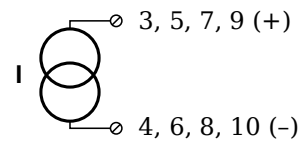
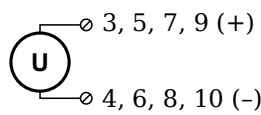

- 1 D_{In}
- 2 D_{Out}
- 3 A_{In} 1+
- 4 A_{In} 1-
- 5 A_{In} 2+
- 6 A_{In} 2-
- 7 A_{In} 3+
- 8 A_{In} 3-
- 9 A_{In} 4+
- 10 A_{In} 4-

Fig. 5-50 Pin assignments for Q.series XL A108

i Tip

For additional information regarding functional procedures for various measurements, refer to Chapter 11 on page 211.

5.13.1

Voltage

For voltage measurements, you can connect signals up to ±10V.

! IMPORTANT

Attempting to measure voltages which exceed the admissible limitations will produce incorrect measurement data as inputs are protected against overvoltage and will therefore limit the input voltage to prevent damage.

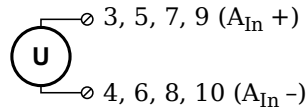

Fig. 5-51 A108, terminal wiring configurations for measurement of voltage (terminal version); for BNC variant, inner contact is A_{In+} and outer conductor is A_{In-}

5.13.2

Current

For current measurements, an external shunt resistance terminal is needed. The external shunt resistance terminal is obtained under the designation *Q.bloxx Terminal SR* from Gantner Instruments or your domestic Gantner Instruments Sales and Service location. The *Q.bloxx Terminal SR* facilitates the measurement of currents up to 25mA for terminal versions of the Q.series XL A108 module.

For the BNC version, you must use a suitable shunt resistance to determine the current from the voltage drop. For current measurements using BNC version of Q.series XL A108, configure the module for voltage measurement.

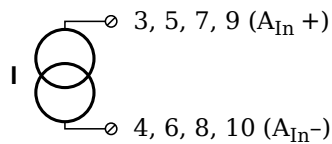

Fig. 5-52 A108, terminal wiring configurations for measurement of current using the *Q.bloxx Terminal SR*

5.13.3

Digital Input and Output

For terminal versions of the Q.series XL A108 module, two contacts are available for a digital input and digital output. You can use the appropriate function depending on the terminal wiring configurations shown in the following diagram.



Fig. 5-53 A108, terminal wiring configurations for digital input and output, available for terminal versions only

The digital input is active (high level) when the applied voltage signal exceeds the threshold of 10V.

5.14

Q.series XL A109: Connecting I/O and Outputs

The Q.series XL A109 has four electrically isolated analog outputs, four digital inputs and four digital outputs. Pin assignments for the connector strips are *not* identical. The plug number is specified in the following. The connection terminals have numbers for identifying the connections.

The designations 0 V and +V designate the (external) supply voltage connections while NC indicates “No Connection”. Analog ground (-) and (external) supply voltage are electrically isolated in the module.

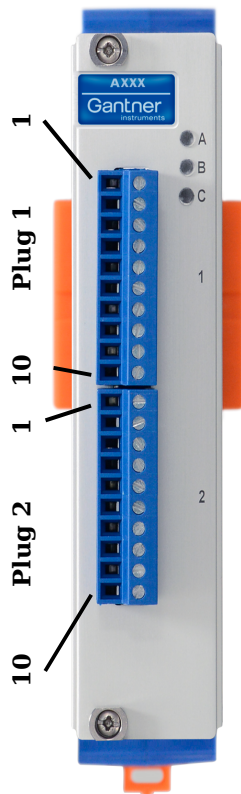

- 1 +V
- 2 D_{Out} 1
- 3 D_{Out} 2
- 4 D_{Out} 3
- 5 D_{Out} 4
- 6 D_{In} 1
- 7 D_{In} 2
- 8 D_{In} 3
- 9 D_{In} 4
- 10 0V

Plug 1, Digital Inputs and Outputs

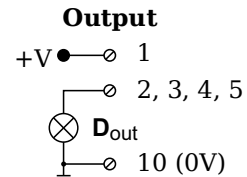
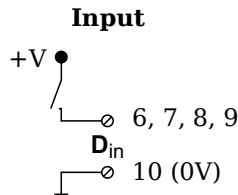

***Input:** Threshold can be programmed as TTL or 10V

***Output:** +V must be between 12V and 30V

- 1 NC
- 2 NC
- 3 A_{Out} 1+
- 4 A_{Out} 1-
- 5 A_{Out} 2+
- 6 A_{Out} 2-
- 7 A_{Out} 3+
- 8 A_{Out} 3-
- 9 A_{Out} 4+
- 10 A_{Out} 4-

Plug 2, Analog Outputs

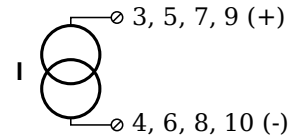
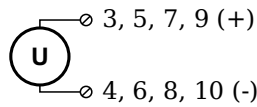

Fig. 5-54 Pin assignments for Q.series XL A109

5.14.1

Digital Input and Output, Terminal 1 Only

Four digital inputs and four digital outputs are available on the Q.series XL A109 via Terminal 1 only. Due to channel-to-channel electrical isolation, you must connect digital inputs to 0V and digital outputs to the supply voltage (+V).

The digital input is active (high level) when the applied voltage signal exceeds the programmable threshold.



Fig. 5-55 A109, terminal wiring configurations for digital input and output, available via Terminal 1 only

The total possible combinations of contact assignments for digital inputs using the Q.series XL A109 are shown in the following table; you may also refer to the block diagrams for the Q.series XL D101 module.

6	7	8	9
status	status	status	status
status	status	2-channel signal ¹⁾	
2-channel signal ¹⁾		2-channel signal ¹⁾	
4-channel signal ²⁾			

- 1) e.g. counter with additional input for counting direction, 2-phase counter signal or frequency measurement with direction detection (torque transducers)
- 2) e.g. counter with additional inputs for counting direction, zero reference and reset/enable for zero reference

5.14.2

Analog Output, Terminal 2 Only

For analog output, two output configurations are available to you via Terminal 2 only: voltage or current. Select the preferred output variant in *GI.bench* (**Analog output type** field in *Variable settings*).



Fig. 5-56 A109, terminal wiring configurations for analog output of voltage or current, available via Terminal 2 only

5.15

Q.series XL A111 BNC: Connect Sensors

The Q.series XL A111 has four electrically isolated analog inputs. The pin assignment of the two connector strips is identical and the connection terminals have numbers for identifying the connections. A BNC variant of the Q.series XL A111 is also available. The designations NC indicates “No Connection”. Measurement ground (-) and (external) supply voltage are electrically isolated in the module.

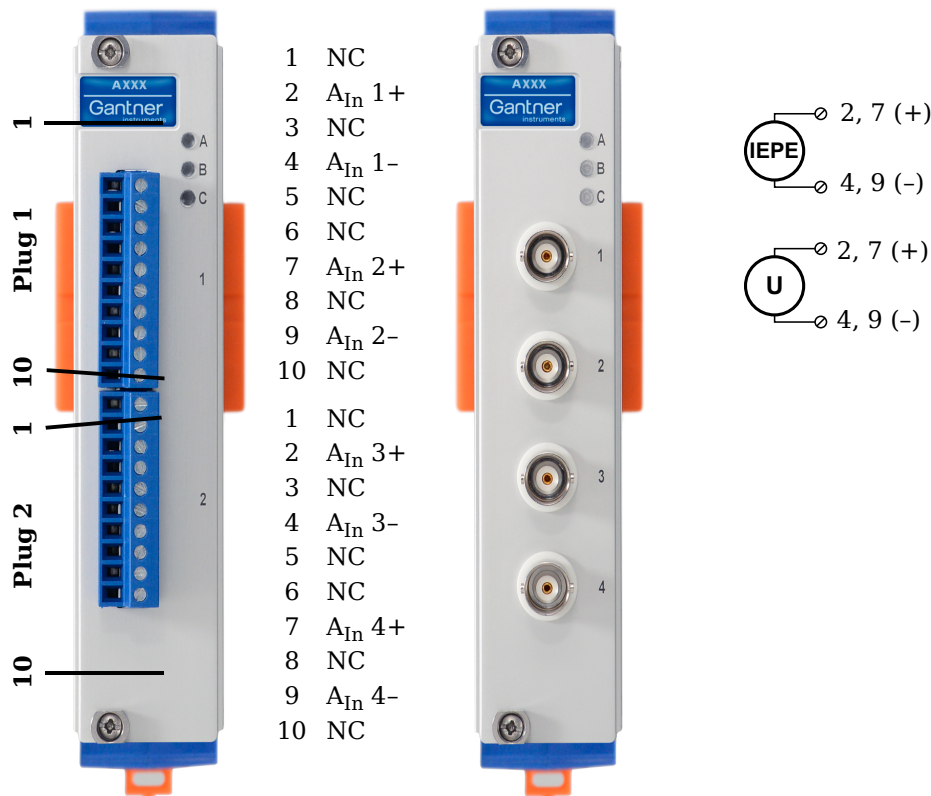

Fig. 5-57 Pin assignments for Q.series XL A111 and BNC variant

i Tip

For additional information regarding functional procedures for various measurements, refer to Chapter 11 on page 211.

5.15.1

Voltage

For voltage measurements, you can connect signals of up to $\pm 10V$.

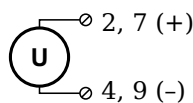

Fig. 5-58 A111, wiring configurations for measurement of voltage

! **IMPORTANT**

Attempting to measure voltages which exceed the admissible limitations will produce incorrect measurement data as inputs are protected against overvoltage and will therefore limit the input voltage to prevent damage.

5.15.2**IEPE/ICP[®]**

For IEPE/ICP[®] measurements, the connected sensor is provided a current supply of 4.5 mA from the Q.series XL A111 module.

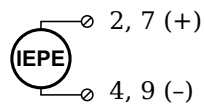

Fig. 5-59 A111, wiring configurations for measurement with IEPE or ICP[®] sensors

5.16

Q.series XL A116: Connecting Sensors

The Q.series XL A116 has eight analog inputs. We recommend that either the Q.series XL Connection Terminal A116 (Fig. 5-61) or the Cable A116 (Fig. 5-62) used with free ends for connection.

The measurement ground channels (-) are electrically isolated from the (external) supply voltage and the connection terminal.

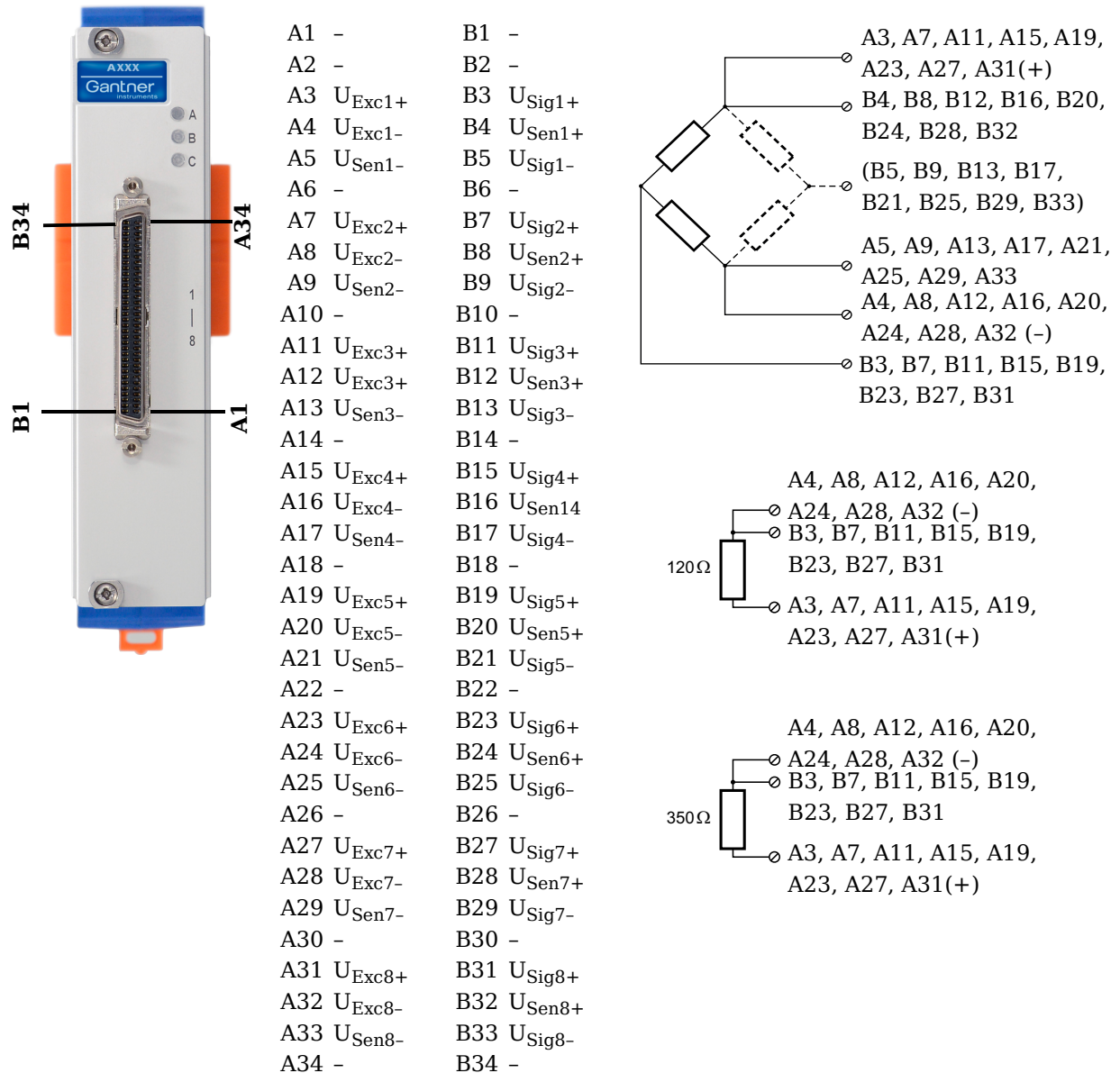

Fig. 5-60 Pin assignments for Q.series XL A116

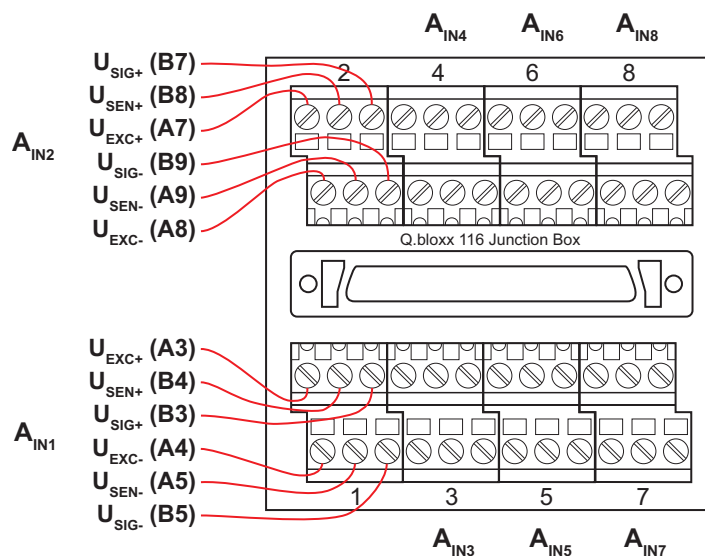

Fig. 5-61 Termination assignments for the Q.series XL Connection Terminal CT A116

Assignment of the cable cores for a cable termination with free ends Cable A116:

Input/ cable bundle	Pairing	Cable color	Sensor connection	Socket connection
1	Pair 1	Light brown	U_{Exc+}	A3
		Light brown/red	U_{Exc-}	A4
	Pair 2	Light green	U_{Sen+}	B4
		Light green/black	U_{Sen-}	A5
	Pair 3	White	U_{Sig+}	B3
		White/black	U_{Sig-}	B5
2	Pair 1	Red/white	U_{Exc+}	A7
		Red/blue	U_{Exc-}	A8
	Pair 2	Yellow/red	U_{Sen+}	B8
		Yellow/blue	U_{Sen-}	A9
	Pair 3	Grey/red	U_{Sig+}	B7
		Grey/blue	U_{Sig-}	B9

Input/ cable bundle	Pairing	Cable color	Sensor connection	Socket connection
3	Pair 1	Blue	U_{Exc+}	A11
		Blue/white	U_{Exc-}	A12
	Pair 2	Pink/red	U_{Sen+}	B12
		Pink/blue	U_{Sen-}	A13
	Pair 3	Light green/yellow	U_{Sig+}	B11
		Light green/green	U_{Sig-}	B13
4	Pair 1	Green/white	U_{Exc+}	A15
		Light green/white	U_{Exc-}	A16
	Pair 2	Light blue/blue	U_{Sen+}	B16
		Light blue/red	U_{Sen-}	A17
	Pair 3	Black	U_{Sig+}	B15
		Black/white	U_{Sig-}	B17
5	Pair 1	Pink	U_{Exc+}	A19
		Pink/black	U_{Exc-}	A20
	Pair 2	Orange/white	U_{Sen+}	B20
		Grey/white	U_{Sen-}	A21
	Pair 3	White/red	U_{Sig+}	B19
		White/blue	U_{Sig-}	B21
6	Pair 1	Light green/red	U_{Exc+}	A23
		Green/blue	U_{Exc-}	A24
	Pair 2	Red	U_{Sen+}	B24
		Red/black	U_{Sen-}	A25
	Pair 3	Purple	U_{Sig+}	B23
		Purple/white	U_{Sig-}	B25

Input/ cable bundle	Pairing	Cable color	Sensor connection	Socket connection
7	Pair 1	Green	U_{Exc+}	A27
		Green/black	U_{Exc-}	A28
	Pair 2	Light blue/green	U_{Sen+}	B28
		Light blue/yellow	U_{Sen-}	A29
	Pair 3	Light yellow	U_{Sig+}	B27
		Light yellow/red	U_{Sig-}	B29
8	Pair 1	Grey	U_{Exc+}	A31
		Grey/black	U_{Exc-}	A32
	Pair 2	White/yellow	U_{Sen+}	B32
		White/green	U_{Sen-}	A33
	Pair 3	Brown	U_{Sig+}	B31
		Brown/white	U_{Sig-}	B33

Fig. 5-62 Assignments while using Cable A116 with flying leads

i Tip

For additional information regarding functional procedures for various measurements, refer to Chapter 11 on page 211.

5.16.1

Full and Half-bridge Transducer

For resistive *full bridge* (strain gage) measurements, six signal connections to the Q.series XL A116 are necessary per channel; the configurations are shown in the diagram below. If you are not utilizing a sensor with sensing leads, you must specify this during module configuration in *GI.bench* (**Analog input type** in settings). In this case, the U_{Sen} inputs remain open. With half bridges the side drawn in dashes and the U_{Sig-} connection are omitted.

For resistive *half bridge* (strain gage) measurements, the dotted sides and connection U_{Sig-} shown in the diagram below are omitted. Internal 120W and 350W bridge completion resistors are available per channel and selectable in *GI.bench* in the **Analog input type** field in *Variable settings*.

The bridge excitation voltage provided by the Q.series XL A116 module is $2V_{DC}$. There is also a bridge excitation voltage of $4V_{DC}$ available for 350Ω sensors. In *GI.bench*, you can specify the supply voltage in the **Analog input type** field in *Variable settings*. The Q.series XL A116 also possesses integrated $100k\Omega$ shunt resistors that can be activated per channel. In *GI.bench*, you can activate the shunt resistance per channel in the **Zero/Tare/Shunt** tab in *Variable settings*. For the activation of the integrated $100k\Omega$ shunt resistors refer to Section 5.16.3.

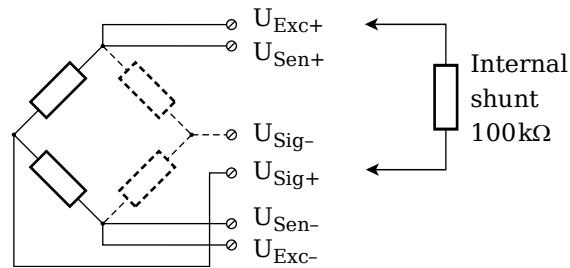

Input 1		Input 2		Input 3		Input 4	
U_{Exc+}	A3	U_{Exc+}	A7	U_{Exc+}	A11	U_{Exc+}	A15
U_{Exc-}	A4	U_{Exc-}	A8	U_{Exc-}	A12	U_{Exc-}	A16
U_{Sen+}	B4	U_{Sen+}	B8	U_{Sen+}	B12	U_{Sen+}	B16
U_{Sen-}	A5	U_{Sen-}	A9	U_{Sen-}	A13	U_{Sen-}	A17
U_{Sig+}	B3	U_{Sig+}	B8	U_{Sig+}	B11	U_{Sig+}	B15
U_{Sig-}	B5	U_{Sig-}	B9	U_{Sig-}	B13	U_{Sig-}	B17

Input 5		Input 6		Input 7		Input 8	
U_{Exc+}	A19	U_{Exc+}	A23	U_{Exc+}	A27	U_{Exc+}	A31
U_{Exc-}	A20	U_{Exc-}	A24	U_{Exc-}	A28	U_{Exc-}	A32
U_{Sen+}	B20	U_{Sen+}	B24	U_{Sen+}	B28	U_{Sen+}	B32
U_{Sen-}	A21	U_{Sen-}	A25	U_{Sen-}	A29	U_{Sen-}	A33
U_{Sig+}	B19	U_{Sig+}	B23	U_{Sig+}	B27	U_{Sig+}	B31
U_{Sig-}	B21	U_{Sig-}	B25	U_{Sig-}	B29	U_{Sig-}	B33

Fig. 5-63 A116, connection terminal wiring configurations for measurement with full and half bridges, direct connection as bridge completion resistors are integrated into module; U_{SIG} = signal voltage (output signal), U_{SEN} = sense lead, U_{EXC} = excitation voltage

For terminal versions of the Q.series XL A116, a special connection terminal is needed as there is insufficient area on the front of the module for the necessary terminations. Special connection terminal can be obtained under the designation *Q.bloxx CT A116* from Gantner Instruments or your domestic Gantner Instruments Sales and Service location.

The termination assignments for the *Q.bloxx CT A116* can be found in Fig. 5-61, page 84 and for the connecting cable with free ends, see Fig. 5-62, page 86 at the beginning of Section 5.16, *Q.series XL A116: Connecting Sensors*.

i Tip

For additional important information regarding using resistive type transducer measurements, refer to Section 11.2, page 214.

5.16.2

Quarter-bridge Strain Gage

For resistive quarter bridge (strain gage) measurements, up to three signal connections to the Q.series XL A116 are necessary per channel; the configurations are shown in the diagram below.

For the Q.series XL A116, a special connection terminal is needed as there is insufficient area on the front of the module for the necessary terminations. Connection terminal is obtained under the designation *Q.bloxx CT A116* from Gantner Instruments or your domestic Gantner Instruments Sales and Service location.

There is no need for a bridge completion connection terminal as the 120Ω and 350Ω bridge completion resistors are integrated into the module and selectable in *GI.bench* in the **Analog input type** field in *Variable settings*.

The bridge excitation voltage provided by the Q.series XL A116 module is $2V_{DC}$. There is also a bridge excitation voltage of $4V_{DC}$ available for 350Ω sensors. In *GI.bench*, you can specify the supply voltage in the **Analog input type** field in *Variable settings*.

The Q.series XL A116 also possesses integrated $100k\Omega$ shunt resistors that can be activated per channel. In *GI.bench*, you can activate the shunt resistance per channel in the **Zero/Tare/Shunt** tab in *Variable settings*. For the activation of the integrated $100k\Omega$ shunt resistors refer to Section 5.16.3.

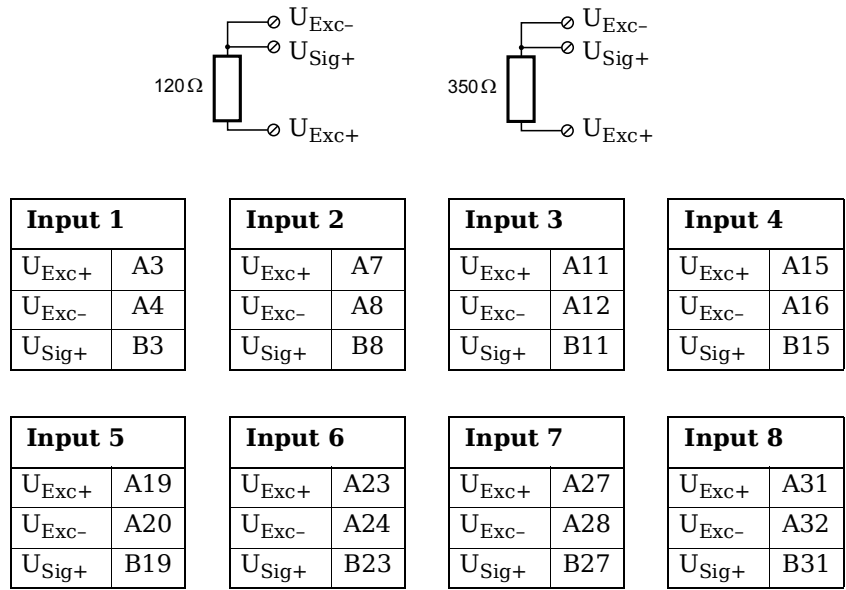

Fig. 5-64 A116, connection terminal wiring configurations for measurement with strain gage quarter bridge using Q.bloxx CT A116, direct connection as bridge completion resistors are integrated into module; U_{SIG} = signal voltage (output signal), U_{EXC} = excitation voltage

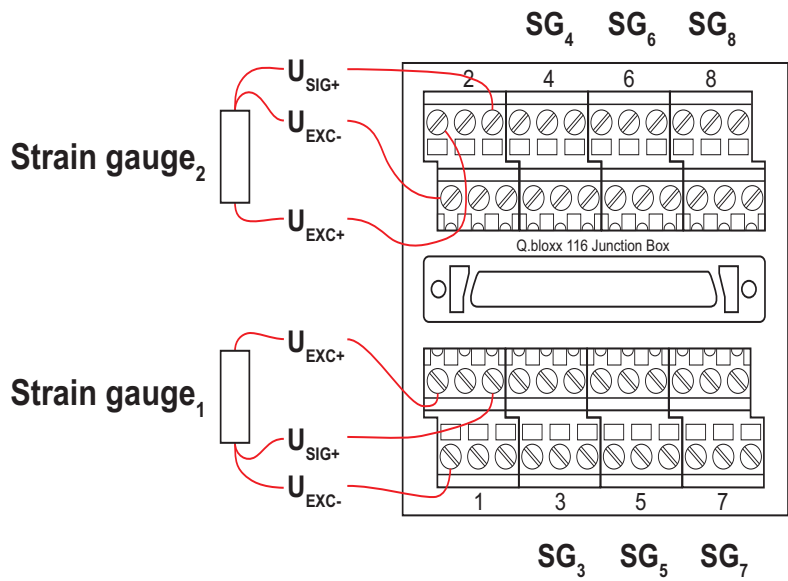

Fig. 5-65 A116, termination assignments for connection terminal Q.series XL CT A116 for measurement with a strain gage quarter bridge

The termination assignments for the Q.bloxx CT A116 can be found in Fig. 5-61, page 84 and for the connecting cable with free ends, see Fig. 5-62, page 86 at the beginning of Section 5.16,

Q.series XL A116: Connecting Sensors. For measurement with quarter bridges, only U_{EXC+} , U_{EXC-} and U_{SIG+} are assigned.

For resistive quarter bridge (strain gage) measurements, the Q.series XL A116 utilizes the integrated 120Ω and 350Ω bridge completion resistances to determine the voltage drop over the cable and correct the resultant data accordingly. With this feature, the influence of temperature on the cable (normal three-wire circuit) is compensated for as well as the loss of sensitivity due to cable resistance over cable length.

5.16.3

Activating the Shunt Resistance

The shunted variable must be an analog input. Shunt resistors are only available in modules with bridge inputs.

In *GI.bench*, there are two methods to activate the integrated 100 kΩ shunt resistor(s): via a variable or via a button (host).

Open the *Variable settings* window by double clicking on the desired variable in *GI.bench*. Click on the **Tare/Zero/Shunt** tab and check the applicable box for the shunt activation type you desire: **Shunt on host** or **Shunt on variable** (Fig. 5-66).

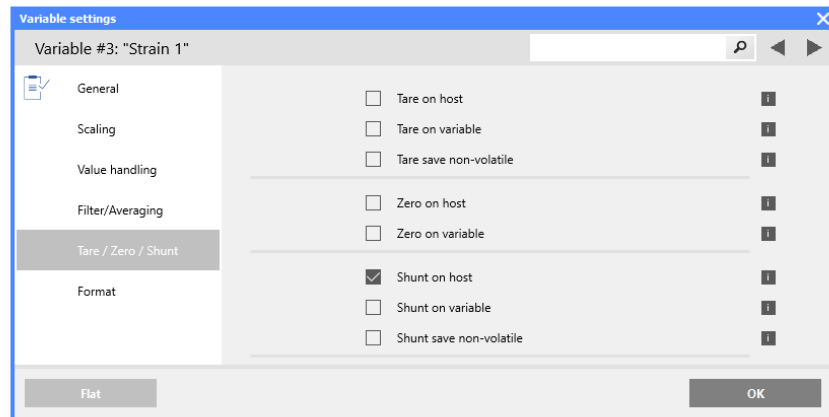

Fig. 5-66 Selecting manual activation of shunt within *GI.bench*

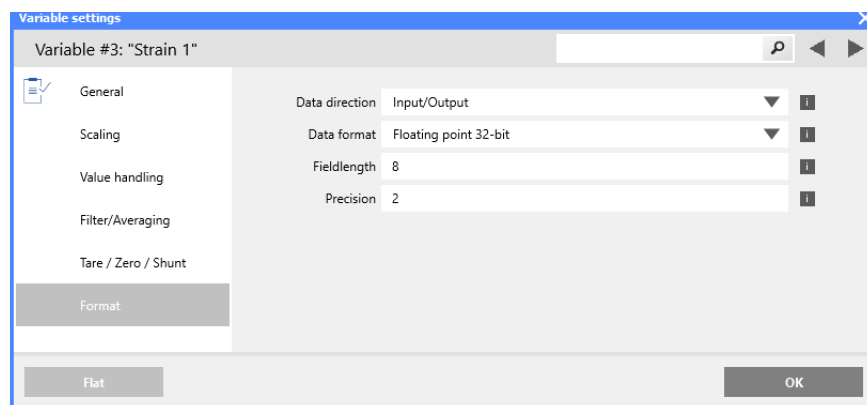

Fig. 5-67 Variable data direction setting in variable *Format* options

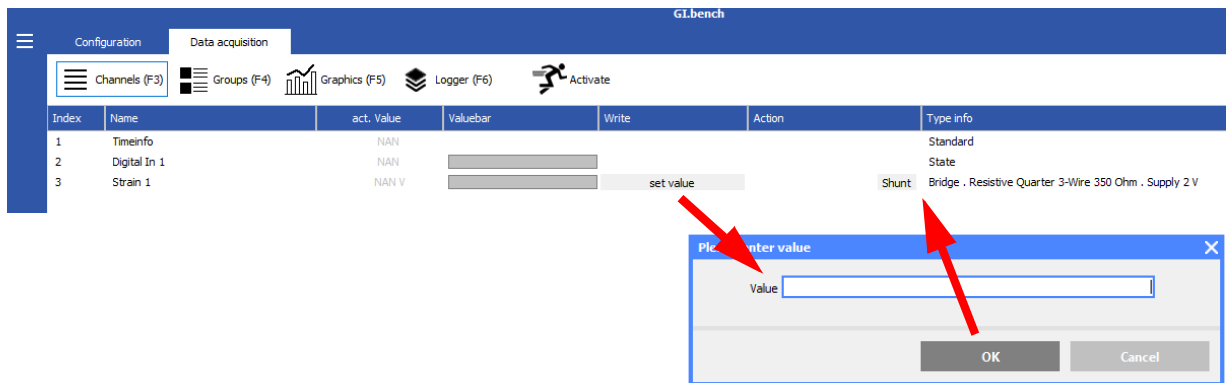

Fig. 5-68 Shunt options in Tare/Zero/Shunt tab of Q.series XL A116; variable shunt on host enables the Shunt button shown

The **Data direction** settings in **Format** options for variable *Strain 1* in Fig. 5-68 are configured for **Input/Output** thus enabling the **set value** button. The user can utilize **Shunt on variable** in **Tare/Zero/Shunt** settings and set the value of a referenced variable, to activate the shunt (i.e., as opposed to using the **Shunt** button in the **Action** column of the **Data acquisition** tab, enabled when **Shunt on host** is activated in **Tare/Zero/Shunt** settings of the variable to be shunted).

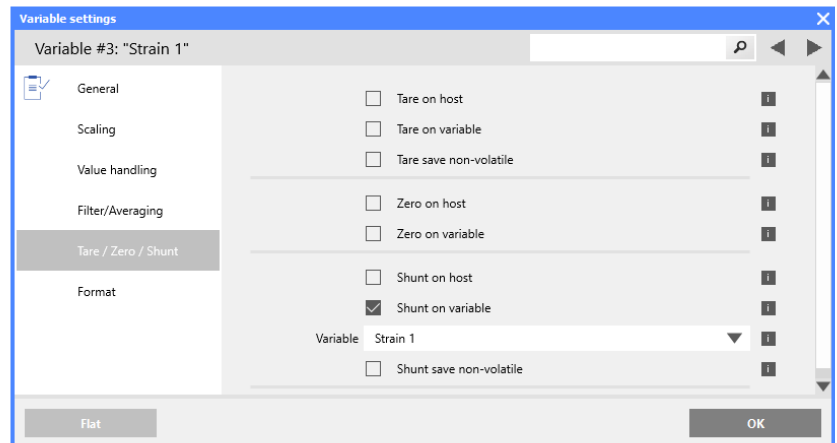

Fig. 5-69 Selecting a variable to automatically activate the shunt in Tare/Zero/Shunt tab

Shunt Activation (via host)

In the **Tare/Zero/Shunt** tab of the *Variable settings* of the variable to be shunted, check the box for **Shunt on host** (Fig. 5-66). In the **Format** tab of the *Variable settings* of the variable to be shunted, define the **Data direction** as **Input/Output** (Fig. 5-67). In *GI.bench*, click the **Data acquisition** tab to access *Channels (F3)* dialog. You should now see the **Shunt** button in the **Action** column (Fig. 5-68, page 91).

Click the **Shunt** button on this screen to manually activate and deactivate the shunt resistance for that channel.

Shunt Activation (via variable)

In the **Tare/Zero/Shunt** tab of *Variable settings* of the variable to be shunted, check the box for **Shunt on variable** (Fig. 5-66).

An additional field will appear under the **Shunt on variable** check box for selecting the desired (referenced) variable that will activate the shunt resistance (Fig. 5-69).

In the **Format** tab of the *Variable settings* of the referenced variable, define the **Data direction** as **Input/Output** (Fig. 5-67).

To activate the shunt during measurement mode, define the value of the selected reference variable as **16**, via the **set value** button in the *Write* column of the *Channels (F3)* dialog under the **View** tab in *GI.bench*.

5.17

Q.series XL A121: Connecting Sensors

DANGER



Voltage inputs of up to 1200V may be connected to Q.series XL A121, A123, A124, A127 and A128 modules.

Before performing service to or with cables or the modules, ensure to *Lockout/Tagout* any connected power supplies.

The Q.series XL A121 can be used in the categories CAT II up to 1000V and CAT III up to 600V and has two electrically isolated analog inputs. The two 6-pole LEMO connectors are identical and their pinouts can be seen in the diagram below.

Measurement ground (-) and the (module) supply voltage are electrically isolated in the module.

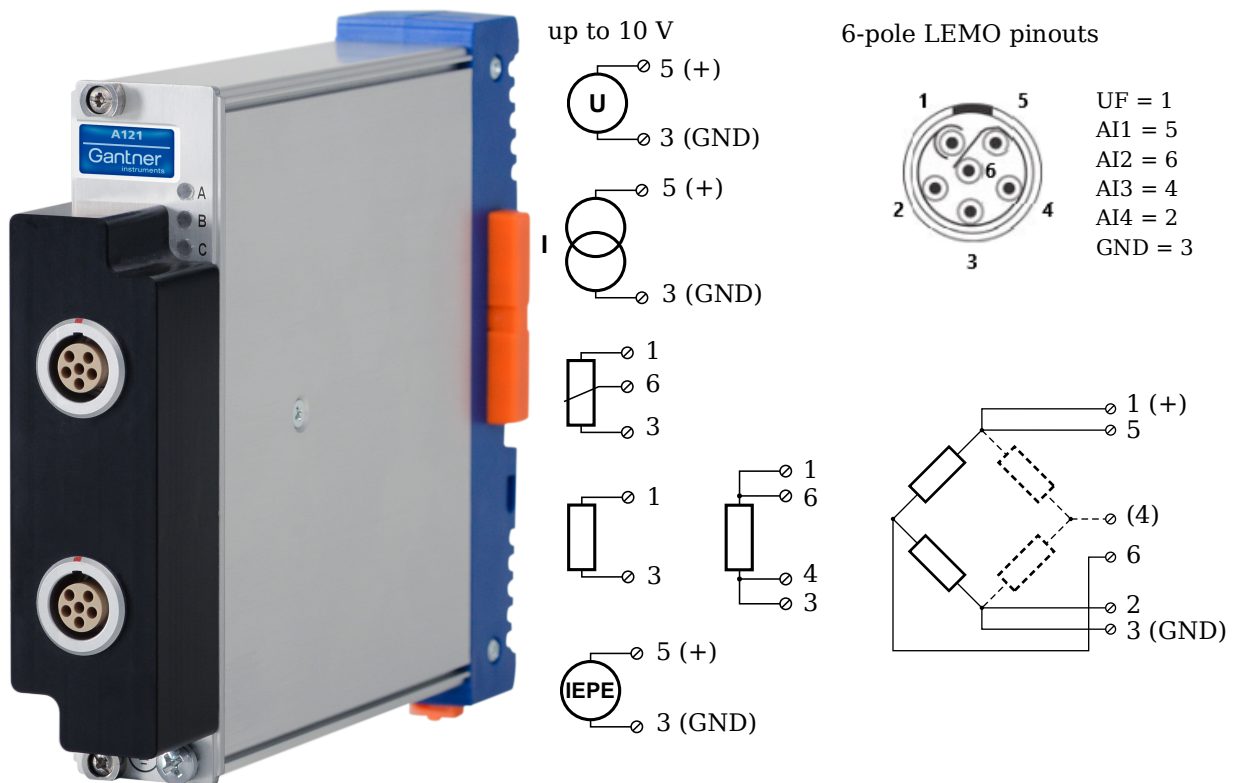

Fig. 5-70 LEMO connector assignments for the Q.series XL A121

5.17.1

Voltage

For voltage measurements, connection is the same regardless of the level of voltages measured: up to $\pm 10V$, $\pm 1V$, and $\pm 100mV$. You can specify the data range while configuring the channel using *GI.bench* (**Hardware defined** or **Maximum** and **Minimum** fields in *Value handling* settings). The voltage level (potential) of the connected signal may be up to $1200V_{DC}$.

! **IMPORTANT**

Attempting to measure voltages that exceed admissible limits will produce incorrect measurement data as inputs are protected against overvoltage and limit input voltage to prevent damage.

Voltages up to 10V

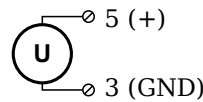

Fig. 5-71 A121, measurement of voltage

5.17.2

Current

For current measurements, an internal shunt resistance of 50Ω is integrated into the Q.series X A121 module. The internal shunt resistor will facilitate the measurement of currents up to 25mA.

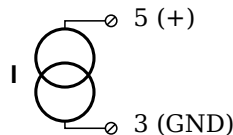

Fig. 5-72 A121, measurement of current

5.17.3

Potentiometer

For potentiometer measurements, resistances between $1\text{k}\Omega$ and $10\text{k}\Omega$ can be connected using a three-wire configuration.

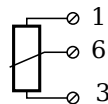

Fig. 5-73 A121, measurement with potentiometers

5.17.4

Resistance, Pt100, Pt1000

For resistance type and RTD (Pt100/Pt1000) measurements, you may connect sensors using either a two-wire or four-wire configuration. You can specify the type of configuration you wish to use while configuring the channel within *GI.bench* (**Analog input type** in *General* settings).

2-wire circuit

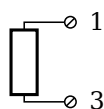

4-wire circuit

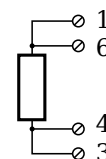

Fig. 5-74 A121, measurement with resistance and Pt100/Pt1000

i Tip

Information regarding transducers and cables with sensing leads can be found in Chapter 7.1 on page 116.

5.17.5**Full and Half-bridge Transducer**

For resistive *full-bridge* (strain gage) measurements, all connections to the Q.series XL A121 shown in the diagram below are necessary. If you are not utilizing a sensor with sensing leads, you must specify this during module configuration in *GI.bench* (**Analog input type** in *General* settings). In this case, inputs 4 and 7 remain open in the diagram below.

For resistive *half-bridge* (strain gage) measurements, the dotted sides and connection 6 shown in the diagram below are omitted. The bridge excitation voltage provided by Q.series XL A121 modules is 2.5V.

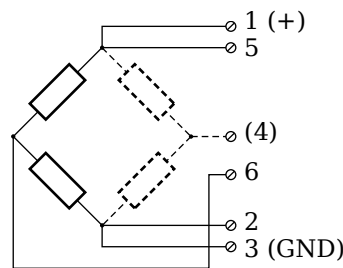

Fig. 5-75 A121, measurement with full- and half-bridges

i Tip

Information regarding transducers and cables with sensing leads can be found in Chapter 7.1 on page 116.

5.17.6**IEPE/ICP[®]**

For IEPE/ICP[®] measurements, the connected sensor is provided a current supply of 4 mA from the Q.series XL A121 module.

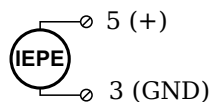

Fig. 5-76 A121, measurement with IEPE or ICP[®] sensors

5.18

Q.series XL A123: Connecting Sensors



Voltage inputs of up to 1200V may be connected to Q.series XL A121, A123, A124, A127 and A128 modules.



Before performing service to or with cables or the modules, ensure to *Lockout/Tagout* any connected power supplies.

The Q.series XL A123 can be used in the categories CAT II up to 1000V and CAT III up to 600V and has four electrically isolated analog inputs. You will find multiple connection assignments listed in sequence in the circuit diagrams, i.e., each connection listed second in sequence belongs to the same sensor connection. Measurement ground (-) and the (module) supply voltage are electrically isolated in the module. The front connectors for the A123 module are security banana, i.e., it is recommended to use cables that also use security banana plugs.

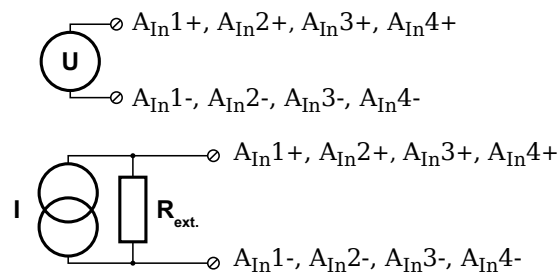
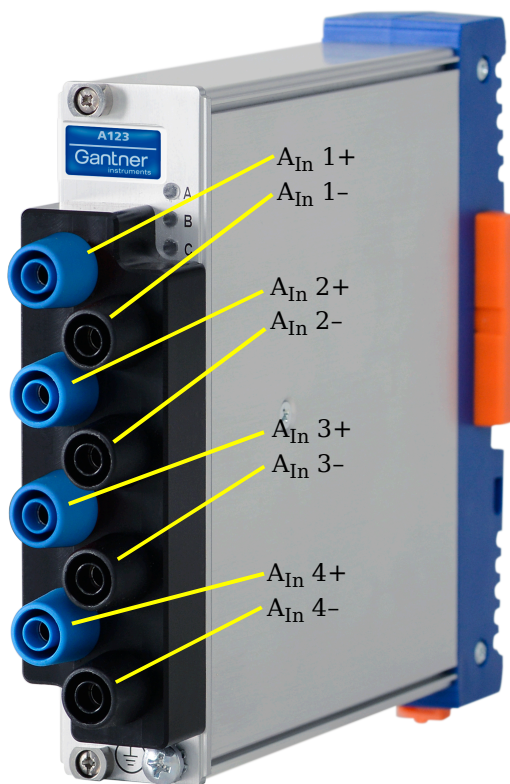

Fig. 5-77 Connection assignments for the Q.series XL A123

5.18.1

Voltage

For voltage measurements, you can connect signals of up to $\pm 10\text{V}$. The voltage level (potential) of the connected signal may be up to 1200V_{DC} .

! IMPORTANT

Attempting to measure voltages which exceed the admissible limitations will produce incorrect measurement data as inputs are protected against overvoltage and will therefore limit the input voltage to prevent damage.

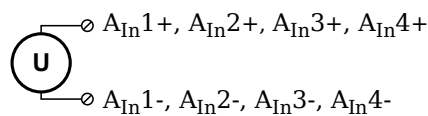

Fig. 5-78 A123, configuration for measurement of voltage using non-terminal version of Q.series XL A123

You need an (external) shunt resistance for the current measurement, refer also to Section 11.5, page 221.

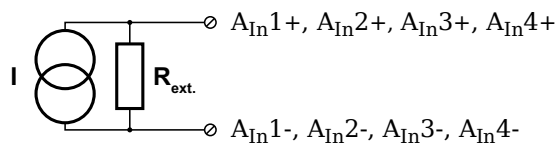

Fig. 5-79 A123, configuration for measurement of current using non-terminal version of Q.series XL A123 and an external shunt resistance

5.19

Q.series XL A124: Connecting Sensors

DANGER



Voltage inputs of up to 1200V may be connected to Q.series XL A121, A123, A124, A127 and A128 modules.

Before performing service to or with cables or the modules, ensure to *Lockout/Tagout* any connected power supplies.

The Q.series XL A124 can be used in the categories CAT II up to 1000V and CAT III up to 600V and has four electrically isolated analog inputs for thermocouples. You will find multiple connection assignments listed in sequence in the circuit diagrams, i.e., each connection listed second in sequence belongs to the same sensor connection.

Measurement ground (-) and the (module) supply voltage are electrically isolated in the module. The plugs for the A124 module are 2-way plugs with push-in spring technology, i.e. you can insert a solid wire or a fine-stranded wire with a wire-end sleeve directly without screwing (max. 1.5 mm²). The plugs are permanently joined to the housing and cannot be removed. With a screwdriver press on the white opener to remove the connection.



Fig. 5-80 Pin assignments for Q.series XL A124

i Tip

Information regarding transducers and cables with sensing leads can be found in Chapter 11.2 on page 214.

5.19.1**Voltage**

For voltage measurements, you can connect signals of up to $\pm 80\text{mV}$. The voltage level (potential) of the connected signal may be up to 1200V_{DC} .

! IMPORTANT

Attempting to measure voltages which exceed the admissible limitations will produce incorrect measurement data as inputs are protected against overvoltage and will therefore limit the input voltage to prevent damage.

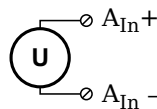

Fig. 5-81 A124, configuration for measurement of voltage using non-terminal version of Q.series XL A124

5.19.2**Thermocouple**

For thermocouple measurements with *internal* cold junction compensation, you can connect thermocouples directly to the Q.series XL A124 as the comparative measuring points (cold junction compensation) are integrated into the module terminations. Alternatively, for thermocouple measurements with *external* cold junction compensation, you can use two thermocouples per temperature measurement or a reference temperature source.

You may connect the following types of thermocouples to the Q.series XL A124 module: B, E, J, K, L, N, R, S, T and U.

i Tip

You can find additional information regarding the necessity of a comparative measuring point for thermocouple measurements as well as additional information on thermocouple measurements with a reference temperature source in Section 11.6, *Measurements with Thermocouples*, page 222.

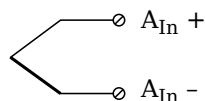

Fig. 5-82 A124, configuration for measurement with thermocouple using non-terminal version of Q.series XL A124

5.20

Q.series XL A127: Connecting Sensors

DANGER



Voltage inputs of up to 1200V may be connected to Q.series XL A121, A123, A124, A127 and A128 modules.

Before performing service to or with cables or the modules, ensure to *Lockout/Tagout* any connected power supplies.

The Q.series XL A127 can be used in the categories CAT II up to 1000V and CAT III up to 600V and has four electrically isolated analog inputs. You will find multiple connection assignments listed in sequence in the circuit diagrams, i.e., each connection listed second in sequence belongs to the same sensor connection. Measurement ground (-) and the (module) supply voltage are electrically isolated in the module. The front connectors for the A127 module are security banana, i.e., it is recommended to use cables that also use security banana plugs.



Fig. 5-83 Connection assignments for the Q.series XL A127

i Tip

Information regarding transducers and cables with sensing leads can be found in Chapter 11.2 on page 214.

5.20.1

Voltage

For voltage measurements, you can connect signals of up to $\pm 1200\text{V}$. There are various hardware defined input voltage ranges from $\pm 40\text{V}_{\text{DC}}$ to $\pm 1200\text{V}_{\text{DC}}$. You can specify the data range while configuring the channel in *GI.bench* (**Hardware defined or Maximum and Minimum fields** in *Value handling* settings). The voltage level (potential) of the connected signal may be up to 1200V_{DC} .

NOTICE

Attempting to measure voltages which exceed 1200V_{DC} may damage the Q.series XL A127 module.

Every Q.series XL A127 module is factory tested at 5kV_{DC} for a duration of one minute. Any longer durations or higher voltage levels can damage the module. In addition, every instance of overvoltage that the Q.series XL A127 is subjected to reduces the service life of the module.

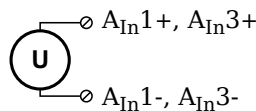

Fig. 5-84 A127, configuration for measurement of voltage using non-terminal version of Q.series XL A127

! IMPORTANT

Attempting to measure voltages which exceed the admissible limitations will produce incorrect measurement data as inputs are protected against overvoltage and will therefore limit the input voltage to prevent damage.

5.20.2

Current**NOTICE**

Incorrectly connecting voltage or current inputs can damage the module and/or the external load resistance. Therefore it is very important to not get the two inputs confused with one another.

Please ensure that high voltage levels are never applied to the current inputs. The voltage drop on current inputs must not exceed $\pm 2.4\text{V}$.

For current measurements, you must use a suitable shunt resistance to determine the current from the voltage drop; refer to Section 11.5, page 221.

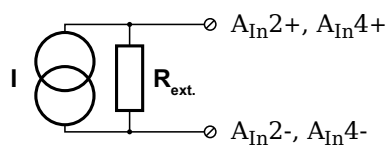

Fig. 5-85 A127, configuration for measurement of current using non-terminal version of Q.series XL A123 and an external shunt resistance

5.21

Q.series XL A128: Connecting sensors

⚠ DANGER

Voltage inputs of up to 1200V may be connected to Q.series XL A121, A123, A124, A127 and A128 modules.

Before performing service to or with cables or the modules, ensure to *Lockout/Tagout* any connected power supplies.

The Q.series XL A128 can be used in the categories CAT II up to 1000V and CAT III up to 600V and has four electrically isolated analog inputs. You will find multiple connection assignments listed in sequence in the circuit diagrams, i.e., each connection listed second in sequence belongs to the same sensor connection. Measurement ground (-) and the (module) supply voltage are electrically isolated in the module. The front connectors for the A128 module are security banana, i.e., it is recommended to use cables that also use security banana plugs.

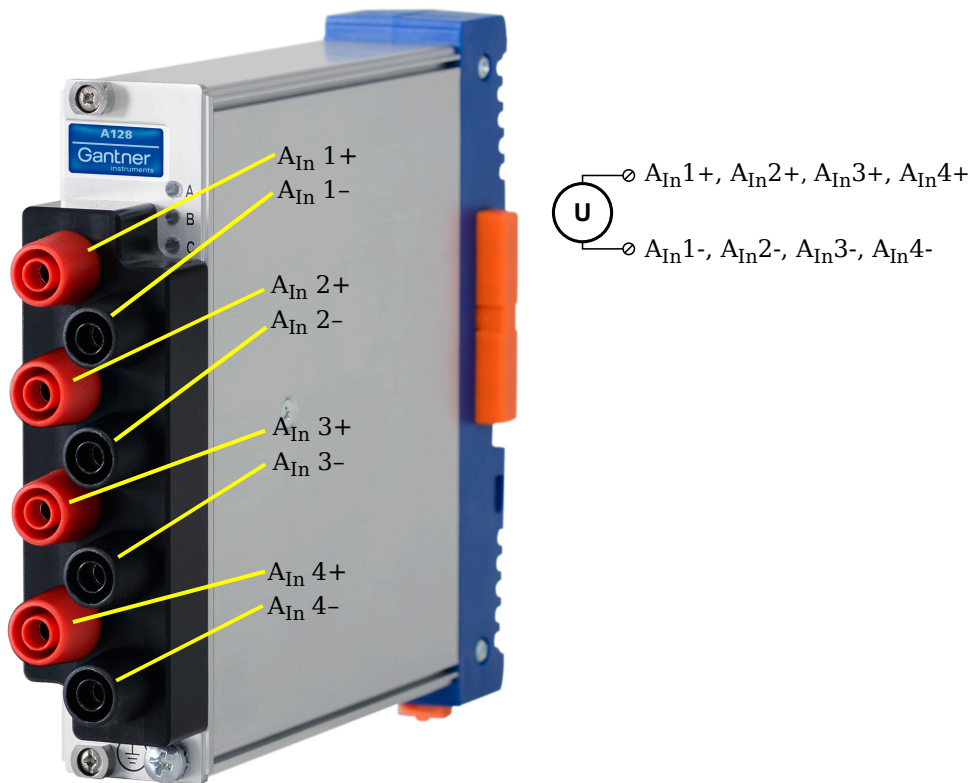

Fig. 5-86 Connection assignments for the Q.series XL A128

i Tip

Information regarding transducers and cables with sensing leads can be found in Chapter 11.2 on page 214.

5.21.1

Voltage

For voltage measurements, you can connect signals of up to $\pm 1200\text{V}$. There are various hardware defined input voltage ranges from $\pm 40\text{V}_{\text{DC}}$ to $\pm 1200\text{V}_{\text{DC}}$. You can specify the data range while configuring the channel in *GI.bench* (**Hardware defined or Maximum and Minimum fields** in *Value handling* settings). The voltage level (potential) of the connected signal may be up to 1200V_{DC} .

NOTICE

Attempting to measure voltages which exceed 1200V_{DC} may damage the Q.series XL A128 module.

Every Q.series XL A128 module is factory tested at 5kV_{DC} for a duration of one minute. Any longer durations or higher voltage levels can damage the module. In addition, every instance of overvoltage that the Q.series XL A128 is subjected to reduces the service life of the module.

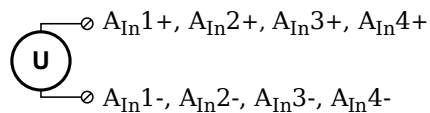

Fig. 5-87 A128, configuration for measurement of voltage using non-terminal version of Q.series XL A128

! IMPORTANT

Attempting to measure voltages which exceed the admissible limitations will produce incorrect measurement data as inputs are protected against overvoltage and will therefore limit the input voltage to prevent damage.

5.22

Q.series XL A141 BNC: Connect Sensors

The Q.series XL A141 has four electrically isolated analog inputs. The connection assignments of the four BNC connectors are identical and have numbers for identifying the connections.

Measurement ground (-) and the module's supply voltage are electrically isolated in the module.

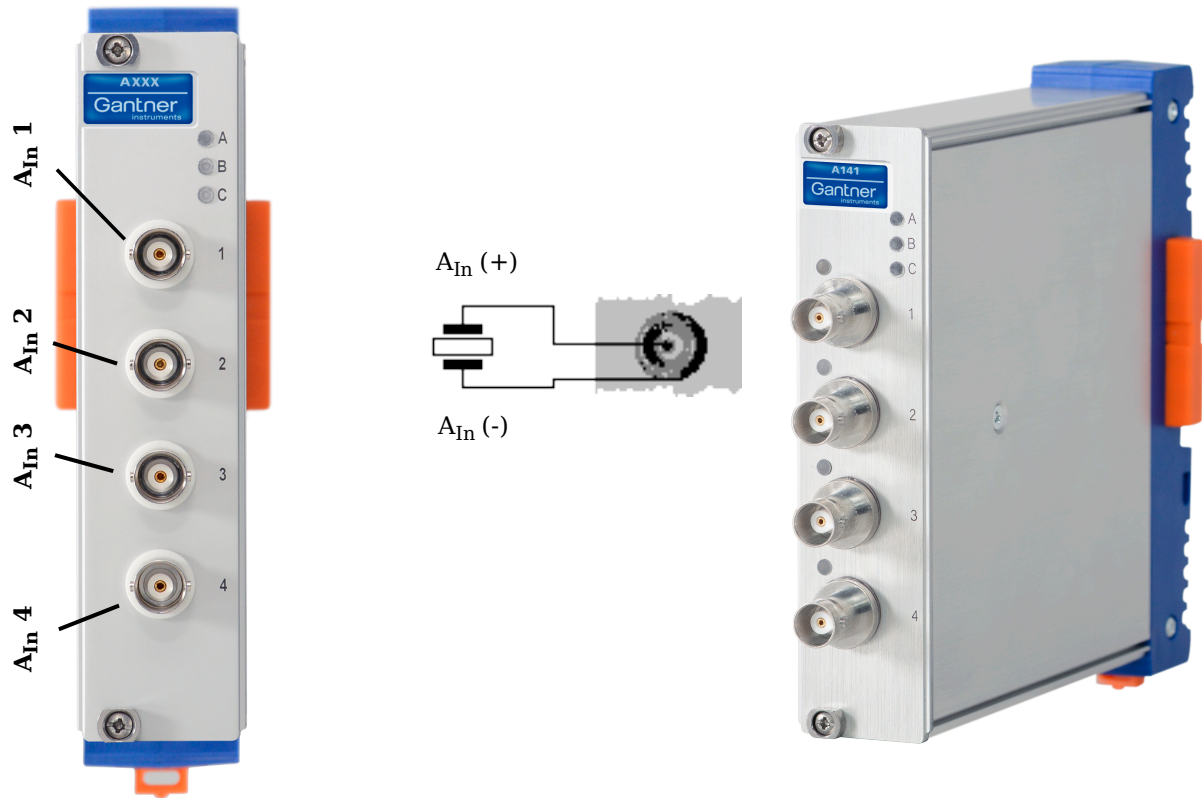

Fig. 5-88 BNC connector assignments for Q.series XL A141 BNC

i Tip

For additional information regarding functional procedures for various measurements, refer to Chapter 11 on page 211.

5.22.1

Piezoelectric, Charge

For piezoelectric measurement of physical quantities, the sensor produces an electric charge which changes in direct proportion with the load acting on it. The Q.series XL A141 module provides universal charge amplification needed for piezoelectric sensors.

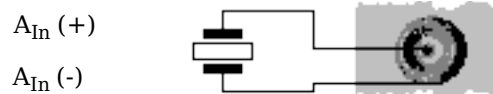

Fig. 5-89 A141, measurement with piezoelectric sensors

5.23

Q.series XL A146: Connecting Sensors

The Q.series XL A146 has sixteen analog inputs for quarter-bridge measurement. It is recommended to use either the 68-pin *Q.bloxx Connection Terminal (CT) A146* (Fig. 5-93, page 111) or *Cable A146* with flying leads (Fig. 5-91, page 109) for connection. All channel connections are electrically isolated from the module supply voltage and the connection terminal. The designation NC signifies “No Connection”.

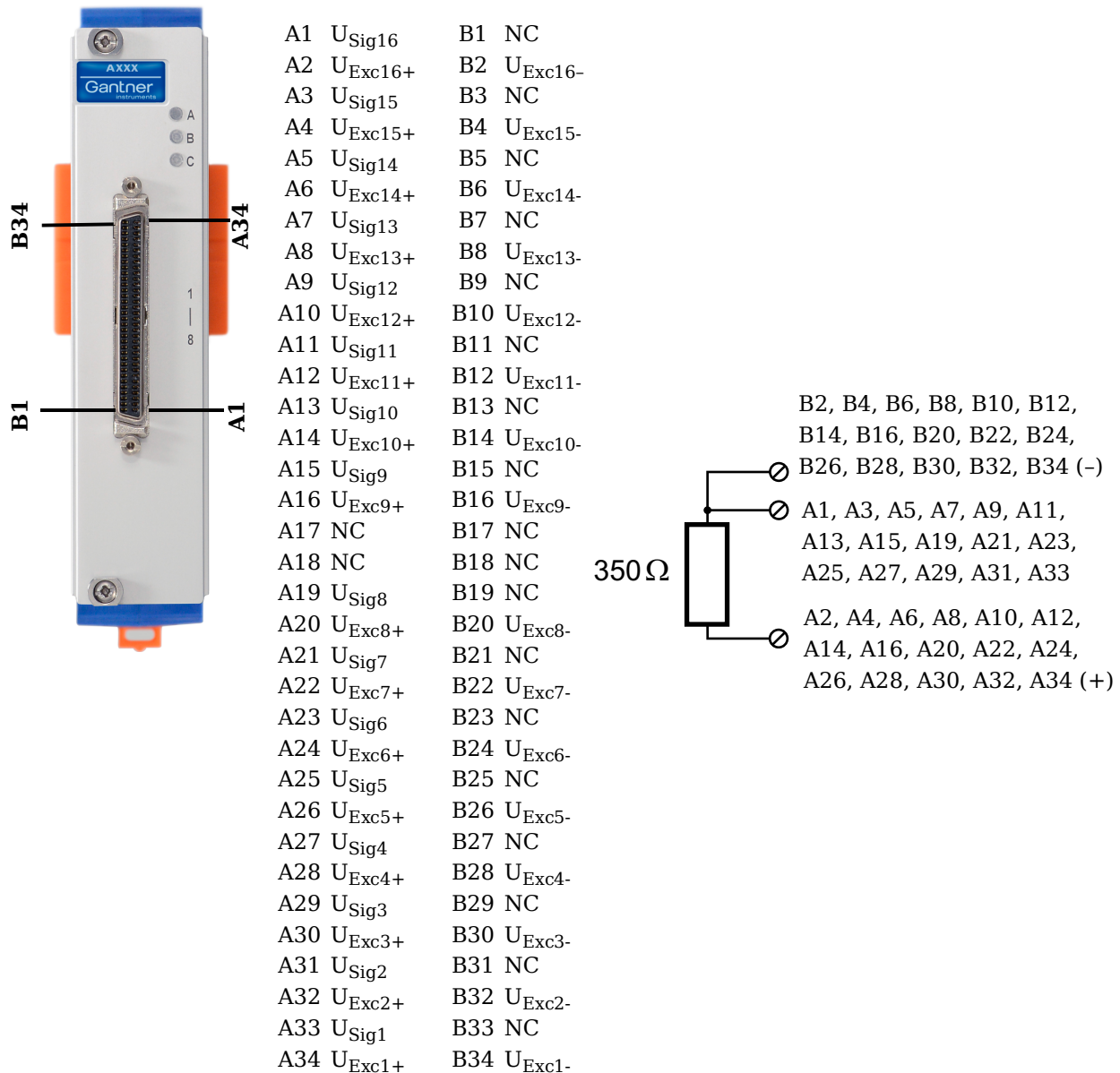

Fig. 5-90 Pin assignments for Q.series XL A146 module

i Tip

For additional information regarding functional procedures for various measurements, refer to Chapter 11 on page 211.

Q.bloxx X Cable A146 with flying leads connection assignments:

Channel	Pairing	Cable color	Sensor connection	Socket connection
16	Pair 1	Light brown	$U_{\text{Sig16+}}$	A1
		Light brown/red	NC	B1
	Pair 2	Light green	$U_{\text{Exc16+}}$	A2
		Light green/black	$U_{\text{Exc16-}}$	B2
15	Pair 1	White	$U_{\text{Sig15+}}$	A3
		White/black	NC	B3
	Pair 2	Red/white	$U_{\text{Exc15+}}$	A4
		Red/blue	$U_{\text{Exc15-}}$	B4
14	Pair 2	Yellow/red	$U_{\text{Sig14+}}$	A5
		Yellow/blue	NC	B5
	Pair 3	Grey/red	$U_{\text{Exc14+}}$	A6
		Grey/blue	$U_{\text{Exc14-}}$	B6
13	Pair 1	Blue	$U_{\text{Sig13+}}$	A7
		Blue/white	NC	B7
	Pair 2	Pink/red	$U_{\text{Exc13+}}$	A8
		Pink/blue	$U_{\text{Exc13-}}$	B8
12	Pair 1	Light green/yellow	$U_{\text{Sig12+}}$	A9
		Light green/green	NC	B9
	Pair 2	Green/white	$U_{\text{Exc12+}}$	A10
		Light green/white	$U_{\text{Exc12-}}$	B10
11	Pair 1	Light blue/blue	$U_{\text{Sig11+}}$	A11
		Light blue/red	NC	B11
	Pair 2	Black	$U_{\text{Exc11+}}$	A12
		Black/white	$U_{\text{Exc11-}}$	B12

Channel	Pairing	Cable color	Sensor connection	Socket connection
10	Pair 1	Pink	U _{Sig10+}	A13
		Pink/black	NC	B13
	Pair 2	Orange/white	U _{Exc10+}	A14
		Grey/white	U _{Exc10-}	B14
9	Pair 1	White/red	U _{Sig9+}	A15
		White/blue	NC	B15
	Pair 2	Light green/red	U _{Exc9+}	A16
		Green/blue	U _{Exc9-}	B16
NC	Pair 1	Red	NC	A17
		Red/black	NC	B17
	Pair 2	Purple	NC	A18
		Purple/white	NC	B18
8	Pair 1	Green	U _{Sig8+}	A19
		Green/black	NC	B19
	Pair 2	Light blue/green	U _{Exc8+}	A20
		Light blue/yellow	U _{Exc8-}	B20
7	Pair 1	Light yellow	U _{Sig7+}	A21
		Light yellow/red	NC	B21
	Pair 2	Grey	U _{Exc7+}	A22
		Grey/black	U _{Exc7-}	B22
6	Pair 1	White/yellow	U _{Sig6+}	A23
		White/green	NC	B23
	Pair 2	Brown	U _{Exc6+}	A24
		Brown/white	U _{Exc6-}	B24
5	Pair 1	Light yellow/green	U _{Sig5+}	A25
		Light yellow/blue	NC	B25
	Pair 2	Yellow	U _{Exc5+}	A26
		Yellow/black	U _{Exc5-}	B26

Channel	Pairing	Cable color	Sensor connection	Socket connection
4	Pair 1	Pink/white	U_{Sig4+}	A27
		Pink/yellow	NC	B27
	Pair 2	Orange	U_{Exc4+}	A28
		Orange/black	U_{Exc4-}	B28
3	Pair 1	Light blue	U_{Sig3+}	A29
		Light blue/black	NC	B29
	Pair 2	Grey/green	U_{Exc3+}	A30
		Grey/yellow	U_{Exc3-}	B30
2	Pair 1	Light yellow/black	U_{Sig2+}	A31
		Yellow/white	NC	B31
	Pair 2	Purple/red	U_{Exc2+}	A32
		Blue/red	U_{Exc2-}	B32
1	Pair 1	Purple/green	U_{Sig1+}	A33
		Purple/blue	NC	B33
	Pair 2	Orange/green	U_{Exc1+}	A34
		Orange/red	U_{Exc1-}	B34

Fig. 5-91 Connection assignments for Cable A146 with flying leads

5.23.1

Quarter-bridge Strain Gage

For resistive quarter-bridge (strain gage) measurements, up to three connections to the Q.series XL A146 are necessary per channel; the configurations are shown in the diagram below.

A special connection terminal is needed due to insufficient area on the front of the Q.series XL A146 module to accommodate all of the necessary terminations. The connection terminal can be obtained under the designation *Q.bloxx CT A146* from your domestic Gantner Instruments Sales and Service location.

There is no need for external bridge completion due to the 350Ω bridge completion resistors integrated in the module.

The bridge excitation voltage provided by the Q.series XL A146 module is $2V_{DC}$.

The Q.series XL A146 possesses integrated 100kΩ shunt resistors that can be activated per channel. In *GI.bench*, you can activate the shunt resistance per channel in the **Zero/Tare/Shunt** tab in *Variable settings*. For the activation of the integrated 100kΩ shunt resistors refer to Section 5.16.3, *Activating the Shunt Resistance*, page 90.

Input 1		Input 2		Input 3		Input 4	
U_{Exc+}	A34	U_{Exc+}	A32	U_{Exc+}	A30	U_{Exc+}	A28
U_{Exc-}	B34	U_{Exc-}	B32	U_{Exc-}	B30	U_{Exc-}	B28
U_{Sig+}	A33	U_{Sig+}	A31	U_{Sig+}	A29	U_{Sig+}	A27

Input 5		Input 6		Input 7		Input 8	
U_{Exc+}	A26	U_{Exc+}	A24	U_{Exc+}	A22	U_{Exc+}	A20
U_{Exc-}	B26	U_{Exc-}	B24	U_{Exc-}	B22	U_{Exc-}	B20
U_{Sig+}	A25	U_{Sig+}	A23	U_{Sig+}	A21	U_{Sig+}	B19

Input 9		Input 10		Input 11		Input 12	
U_{Exc+}	A16	U_{Exc+}	A14	U_{Exc+}	A12	U_{Exc+}	A10
U_{Exc-}	B16	U_{Exc-}	B14	U_{Exc-}	B12	U_{Exc-}	B10
U_{Sig+}	A15	U_{Sig+}	A13	U_{Sig+}	A11	U_{Sig+}	A9

Input 13		Input 14		Input 15		Input 16	
U_{Exc+}	A8	U_{Exc+}	A6	U_{Exc+}	A4	U_{Exc+}	A2
U_{Exc-}	B8	U_{Exc-}	B6	U_{Exc-}	B4	U_{Exc-}	B2
U_{Sig+}	A7	U_{Sig+}	A5	U_{Sig+}	A3	U_{Sig+}	A1

Fig. 5-92 A146, terminal wiring for measurement with strain gage quarter bridge using Q.bloxx CT A146, bridge completion resistors are integrated into module; U_{SIG} = signal voltage (output signal), U_{EXC} = excitation voltage

Q.bloxx CT A146 is shown in Fig. 5-93, page 111 and the assignments for connecting Cable A146 with free ends can be found in Fig. 5-91, page 109. For measurement with quarter bridges, only U_{Exc+} , U_{Exc-} and U_{Sig+} are assigned.

For resistive quarter-bridge (strain gage) measurements, the Q.series XL A146 utilizes integrated 350Ω bridge completion resistors to determine the voltage drop over the sensor cable and corrects the resultant data accordingly. With this feature, the influence of temperature on the cable (normal three-wire circuit) is compensated for as well as the loss of sensitivity due to cable resistance over cable length.

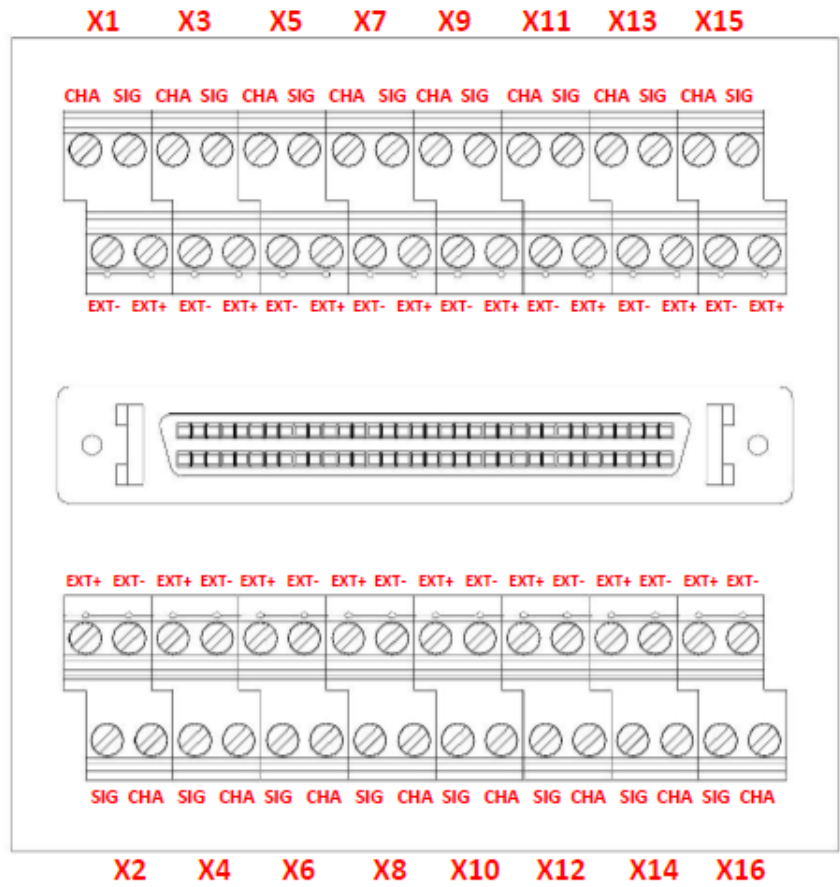

Fig. 5-93 A146, termination assignments for connection terminal Q.series XL CT A146 for measurement with a strain gage quarter bridge

5.24

Q.series XL D101: Connecting I/O

The Q.series XL D101 has eight digital inputs and eight digital outputs. The pin assignment of the two connector strips is identical and the connection terminals have numbers for identifying the connections. You will find the associated figures in each case at the same place in the circuit diagrams, for example each of the figures quoted in the second place belong to one possible connection method. The designations 0 V and +V refer to the (external) supply voltage connections.

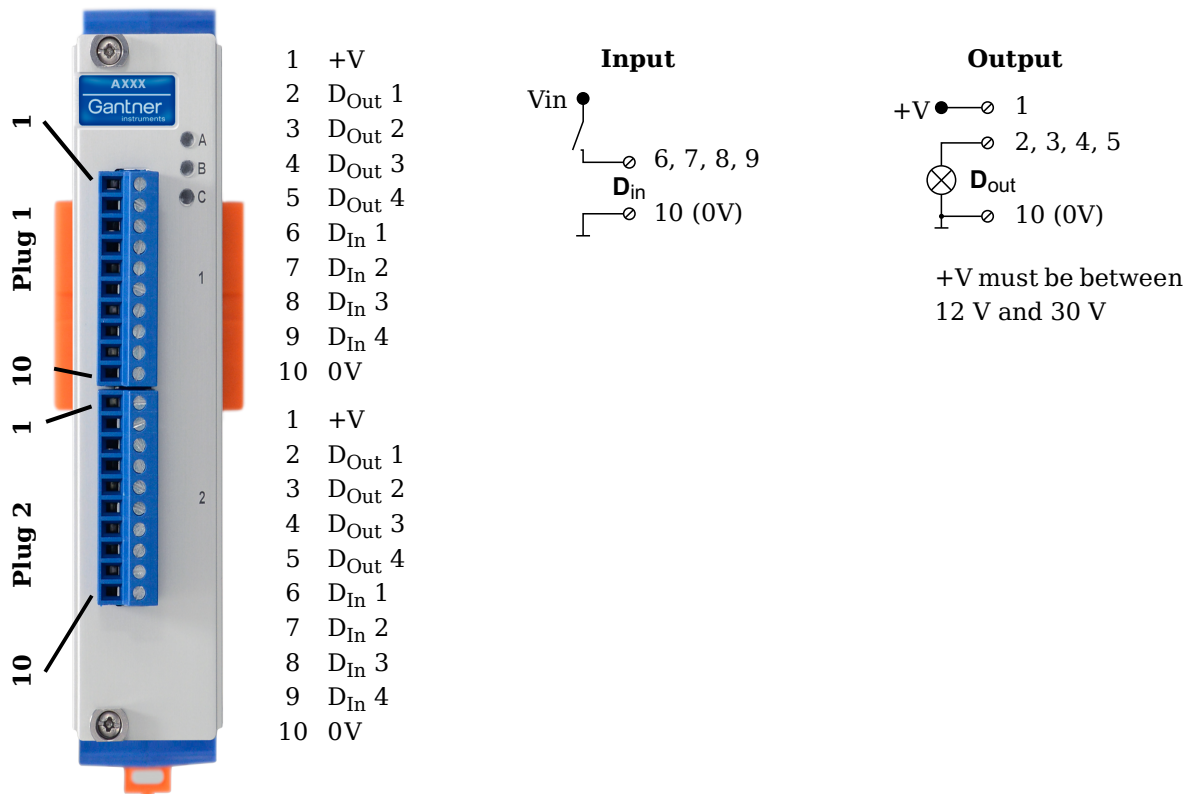

Fig. 5-94 Pin assignments for Q.series XL D101

5.24.1

Digital Input and Output

On each Q.series XL D101 terminal, there are four contacts available for digital inputs and four contacts available for digital outputs. You can use the appropriate function(s) depending on the terminal wiring configurations shown in the following diagram. Due to channel-to-channel electrical isolation, you must connect digital inputs to 0V and digital outputs to the supply voltage (+V).

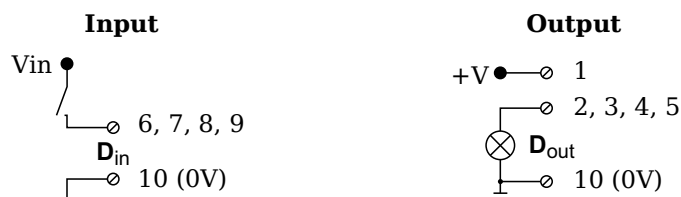
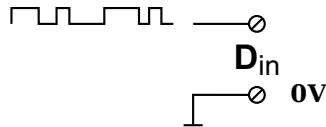

Fig. 5-95 D101, wiring configurations for digital input and output

The digital input is active (high level) when the applied voltage signal, V_{in} , exceeds the programmable threshold.

The following block diagrams provide an overview of the possible circuit configurations.

Measurement of status, time, frequency or PWM (Pulse-Width Modulation), 1 signal



Up/down counter or measurement of frequency and direction with static direction signal, 2 signals

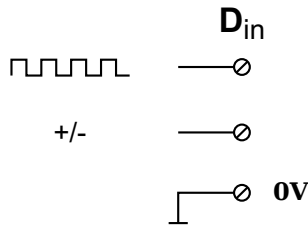

Measurement of frequency and direction or up/down counter with 2-channel frequency signal (90° phase delay)

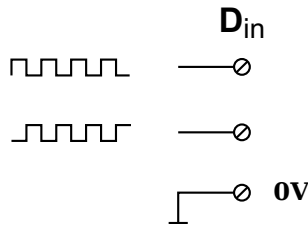

Measurement of frequency and direction or up/down counter with 4-channel frequency signal

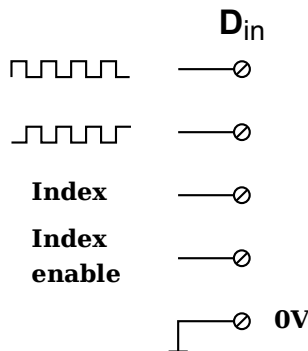

5.25

Q.series XL D104: Connecting Digital Inputs

The Q.series XL D104 has sixteen digital inputs. The pin assignment of the two connector strips is identical and the connection terminals have numbers for identifying the connections. You will find the associated figures in each case at the same place in the circuit diagrams, for example each of the figures quoted in the second place belong to one possible connection method.

The designations 0 V and +V refer to the digital input voltage connections (10V or TTL) while NC indicates “Not Connected”.

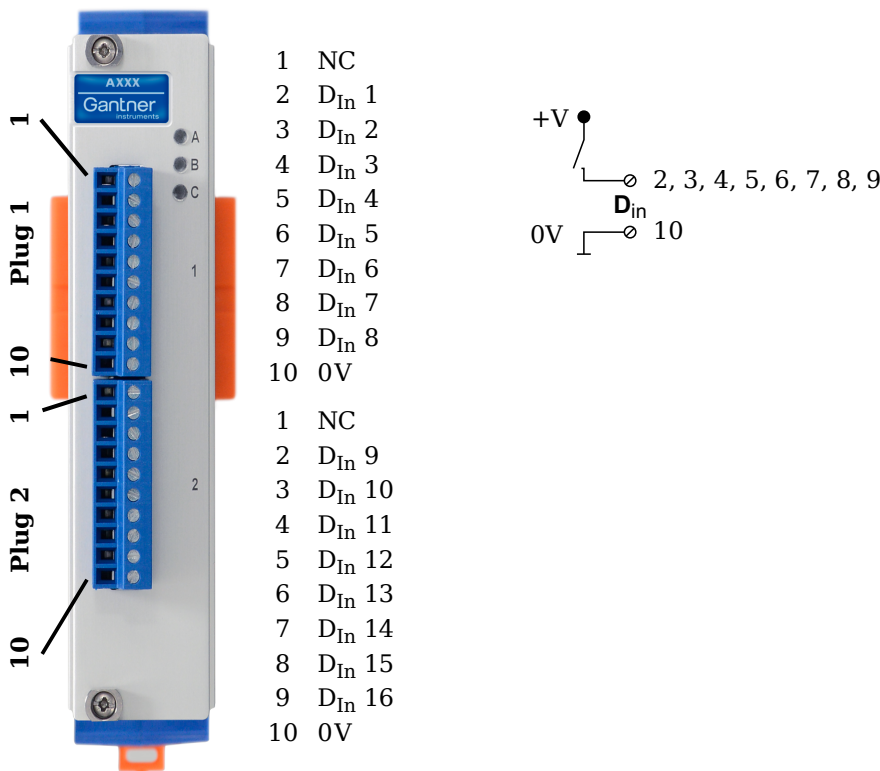

Fig. 5-96 Pin assignments for Q.series XL D104

5.25.1

Digital Input

On each Q.series XL D104 terminal, there are eight contacts available for digital inputs. Due to channel-to-channel electrical isolation, you must connect digital inputs to 0V.

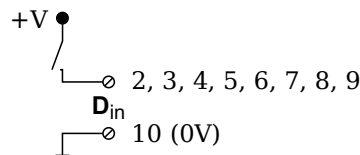

Fig. 5-97 D104, terminal wiring configurations for digital input

The digital input is active (high level) when the applied voltage signal exceeds the programmable threshold, TTL or 10V.

5.26

Q.series XL D105: Connecting Digital Outputs

The Q.series XL D105 has sixteen digital outputs. The pin assignment of the two connector strips is identical and the connection terminals have numbers for identifying the connections. You will find the associated figures in each case at the same place in the circuit diagrams, for example each of the figures quoted in the second place belong to one possible connection method.

The designations 0 V and +V refer to the (external) supply voltage connections.

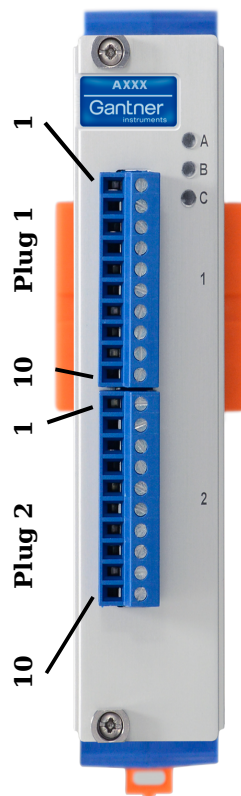

- 1 +V
- 2 D_{Out} 1
- 3 D_{Out} 2
- 4 D_{Out} 3
- 5 D_{Out} 4
- 6 D_{Out} 5
- 7 D_{Out} 6
- 8 D_{Out} 7
- 9 D_{Out} 8
- 10 0V

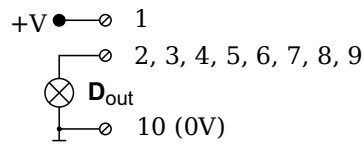

+V must be between 12 V and 30 V

- 1 +V
- 2 D_{Out} 9
- 3 D_{Out} 10
- 4 D_{Out} 11
- 5 D_{Out} 12
- 6 D_{Out} 13
- 7 D_{Out} 14
- 8 D_{Out} 15
- 9 D_{Out} 16
- 10 0V

Fig. 5-98 Pin assignments for Q.series XL D105

5.26.1

Digital Output

On each Q.series XL D104 terminal, there are eight contacts available for digital outputs. Due to channel-to-channel electrical isolation, you must connect digital inputs to 0V and digital outputs to the supply voltage (+V).

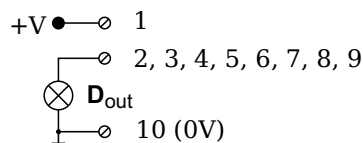

Fig. 5-99 D105, terminal wiring configurations for digital output

5.27

Q.series XL D107: Connecting Digital Inputs

The Q.series XL D107 has sixteen digital inputs. The pin assignment of the two connector strips is identical and the connection terminals have numbers for identifying the connections. You will find the associated figures in each case at the same place in the circuit diagrams, for example each of the figures quoted in the second place belong to one possible connection method.

The designations 0 V (GND) and +V refer to the supply voltage connections for supplying the sensors. NC signifies “No Connection”. Both terminals are electrically isolated from one another and from the module supply voltage.

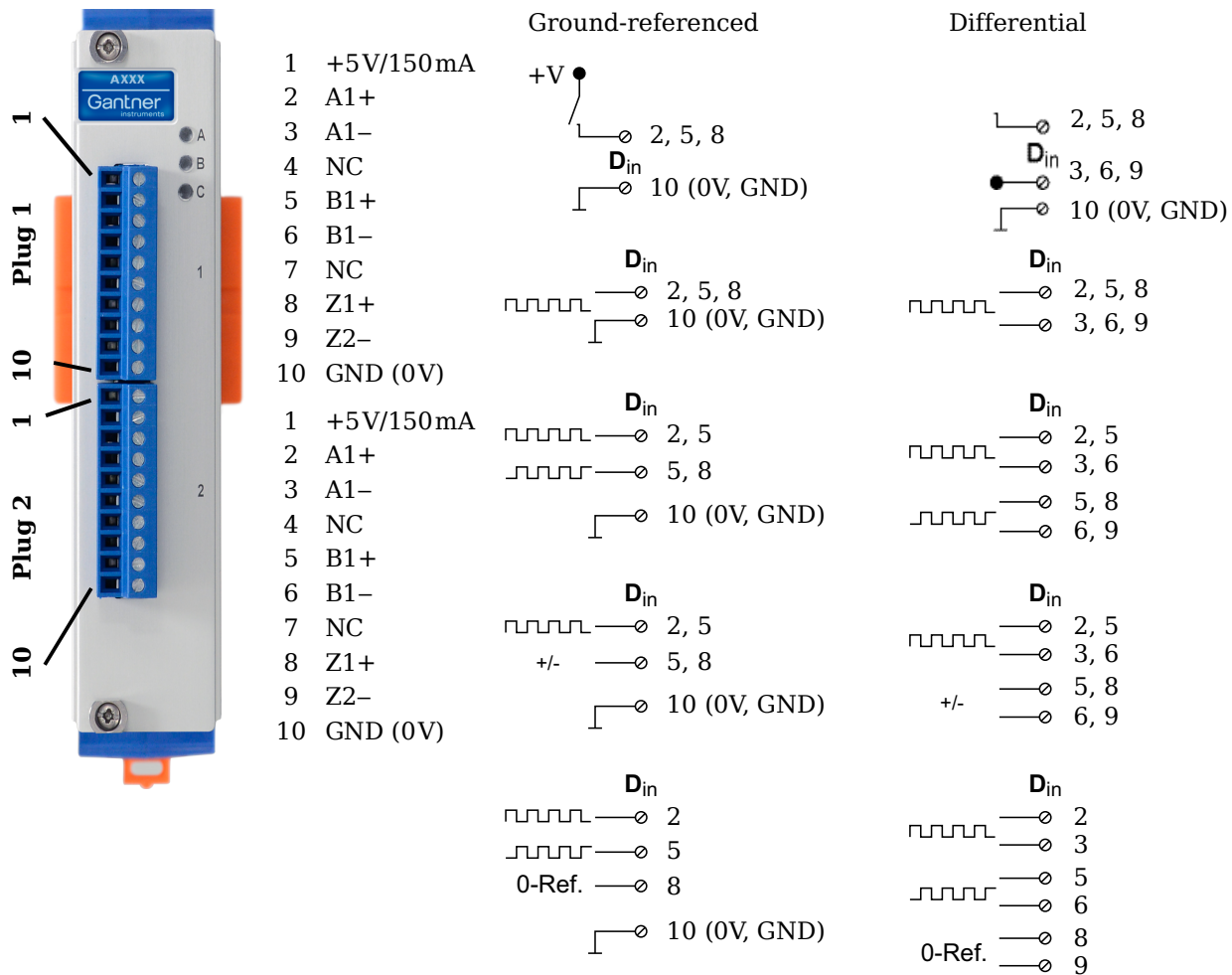

Fig. 5-100 Pin assignments & circuit variants for Q.series XL D107

5.27.1

Digital Input

On each Q.series XL D107 terminal, there are three contacts available for digital inputs. The connected digital inputs can be differential or ground referenced (single-ended). Due to channel-to-channel electrical isolation, you must connect digital inputs to 0V and the supply voltage (+V), even when using differential digital inputs.

The supply voltage (+V) is 5V and maximum 150mA per terminal on the Q.series XL D107.

The digital input is active (high level) when the applied voltage signal exceeds the programmable thresholds. The thresholds can be configured in the *Variable settings* window in *GI.bench* under the **Digital input** tab. For differential measurements, the threshold can be configured as any of 256 steps between $\pm 20V$, otherwise the threshold range is typically between 0V and +26V.

The total possible combinations of contact assignments for digital inputs via Terminal 1 of the Q.series XL D107 are shown in the following table (Dx = Sensor x):

Operating mode	Terminal.Contact						
	1.2 (A1+)	1.3 (A1-)	1.5 (B1+)	1.6 (B1-)	1.8 (Z1+)	1.9 (Z1-)	1.10 (0V)
3 x standard ¹⁾ , differential	D ₁₊₁	D ₁₋₁	D ₂₊₁	D ₂₋₁	D ₃₊₁	D ₃₋₁	GND
3 x standard, single-ended	D ₁₊₁	—	D ₂₊₁	—	D ₃₊₁	—	GND
1 x 2 sensor signals ²⁾ + 1 x standard, differential	D ₁₊₁	D ₁₋₁	D ₁₊₂	D ₁₋₂	D ₂₊₁	D ₂₋₁	GND
1 x 2 sensor signals + 1 x standard, single-ended	D ₁₊₁	—	D ₁₊₂	—	D ₂₊₁	—	GND
1 x 3 sensor signals ³⁾ , dif- ferential	D ₁₊₁	D ₁₋₁	D ₁₊₂	D ₁₋₂	D ₁₊₃	D ₁₋₃	GND
1 x 3 sensor signals, sin- gle-ended	D ₁₊₁	—	D ₁₊₂	—	D ₁₊₃	—	GND

- 1) e.g. status input, frequency measurement or counter
- 2) e.g. counter with additional input for counting direction (forwards/reverse counter) or 2-phase counter signals (quadrature counter) or frequency measurement with direction detection (torque transducers)
- 3) e.g. 2-phase counter signal or angle sensor with additional input for zero reference

The following diagrams are examples of connections of various types of sensors to the Q.series XL D107. For each example, only one sensor and one variant is shown. The connection of a single digital input is not considered in the diagrams (e.g. the sensors in Fig. 5-102 and Fig. 5-103 can be connected at 5/6 and 8/9, and still allow for connections 2/3 which can be an additional standard sensor or digital input). The Q.series XL D107 allows for the mixture of ground-referenced and differential sensor connections on each terminal assuming there is enough room for additional connections to be made.

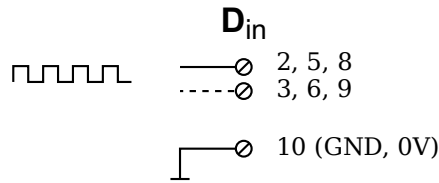

Fig. 5-101 D107, example of sensor with one signal, single-ended or differential input (dotted line)

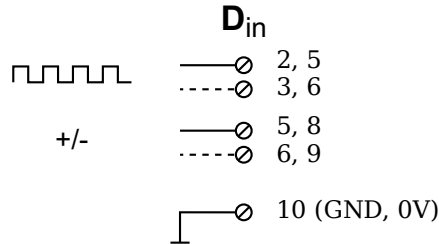

Fig. 5-102 D107, example of sensor with two signals (counting direction), single-ended or differential input (dotted line)

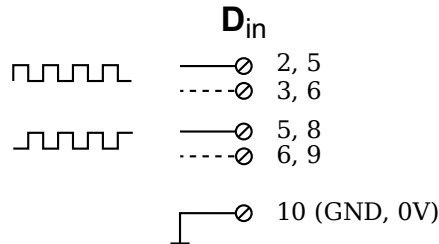

Fig. 5-103 D107, example of sensor with two signals (90° offset), single-ended or differential input (dotted line)

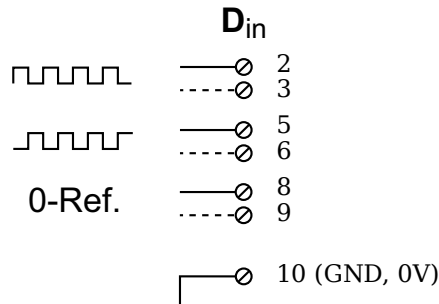

Fig. 5-104 D107, example of sensor with three signals (2 x 90° offset and zero ref.), single-ended or differential input (broken line)

6

Connect Q.station X to a PC

This chapter describes how to connect a Q.station X to a PC.

For a description of how to connect a Q.series XL system and its modules, refer to Chapter 5, *System Assembly & Setup*, page 37.

If remote control of the Q.station X via VNC or web server is established, you may enter the IP address via the display. Otherwise you must first establish communication once only with the Q.station X via the *GI.bench* program. This can take place via a fixed IP address or the automatic address allocation (DHCP). If necessary, you can then allocate a fixed address for further operation to the Test Controller; refer to Section 7.1.3.2, page 146.

6.1

Connect to an Ethernet network via DHCP

The factory default setting for the network interface on the Q.station X test controller is DHCP (Dynamic Host Configuration Protocol). With DHCP enabled, the Q.station X receives a valid network address from a server within the network. If a PC is connected to an Ethernet switch on the same network, an IP address is assigned automatically to the Q.station X allowing for direct connection to the Q.station X via *GI.bench*.

i Tip

Industrial Ethernet switches are recommended for use with the Q.series XL as it supports autonegotiation and can operate at 100Mbps if available with full-duplex data transmission.

6.2

Connect to an Ethernet network via Static IP

If you are not connected to a network or if there is no DHCP server on your network, you have the following options for establishing a connection with the Q.station X:

You can assign your PC a static IP address in the range of 192.168.1.x:

In principle, you can use the static IP address on your PC to establish a direct connection with the Q.station X. The static IP address on your PC must be within the same address range as the IP address of the Q.station X. If the Q.station X does not receive an IP address from a DHCP server within a few seconds, it will then set itself back to its configured default IP address. This IP address is visible via the Q.station X graphical HMI display (DisplayPort interface), if indeterminable. The factory default setting for the static IP address on the Q.station X is 192.168.1.28. To establish a direct connection with the Q.station X, assign the PC a static IP address within the same range (e.g., 192.168.1.10).

The digital graphical HMI display can be referenced if connected via DisplayPort to determine if the Q.station X is configured for static IP address or DHCP. Once a connection is established with a PC, the digital graphical HMI display of the Q.station X can be accessed via VNC; refer to Chapter 10.2, *Remote Control Q.station X via VNC*, page 206.



Fig. 6-1 Network tile with view of the IP address in the HMI

i Tip

Refer also to Section 6.7, *Ethernet on the PC*, page 132, to modify the IP address of your PC.

6.3

GI.bench: Configuration Software

GI.bench is the recommended software for the configuration of any Q.series X product and it can be used to configure almost any other product developed by Gantner Instruments, i.e., the products capable of connecting to a Q.station Test Controller.

You may define Q.series X configurations from within a project in *GI.bench*. Projects are user-defined Gantner system templates, which contain the majority, if not all of the necessary settings for configuring a Gantner system or network of systems for specific operations per the unique needs of the user. The user can also define both inputs from and outputs to external systems or other non-Gantner devices if they possess the compatible methods of communication supported by Q.series X, e.g., USB, CAN, etc.

Projects can be created *off-line* or without connecting hardware to the network or PC. Creating an *off-line* configuration project can help simulate the configuration of an entire system without needing the physical hardware. For the first time using *GI.bench*, however, we recommend (Q.series X) hardware be connected.

Since Gantner systems typically consist of a Test Controller and multiple measurement modules, when first receiving or building a Q.series XL system, you must ensure all module addresses are properly specified, either via the DIP switch terminals on module sockets (refer to Section 5.2.3, *Configure Module Addresses via DIP Switch (Optional)* on page 41) or via *GI.bench*. The procedure for setting addresses via *GI.bench* is described in Section 6.4, *Establish a Connection*, page 124.

6.3.1

Creating Projects in *GI.bench*

A *GI.bench* project is a digital blueprint used to define all aspects pertinent to a Q.series XL system (excluding *test.con* programs), including the sensor and I/O settings available within modules as well as system data streams for data visualization, loggers for the storage of data, and virtual variables which can consist of custom computations, system statuses, or outputs.

The following methods can be used to create a *GI.bench* project:

Method

- On initial start up of *GI.bench*, a new project is automatically created with the default project name: **unnamed**. A project cannot be saved with the name “unnamed” however, any changes made to the configurations within the default project “unnamed” are automatically saved to that instance of the default project. If *GI.benchUI* is closed while the “unnamed” project is open, that instance of the “unnamed” project will appear when *GI.benchUI* is next opened. Any changes made to a default project immediately overwrite the previously unsaved “unnamed” project settings but are only cached within the *last project opened* memory of *GI.service*, i.e., changes to any configurations within a project called “unnamed” will only be stored until another project is opened within *GI.benchUI* (e.g., Fig. 6-2, page 122) or the next time *GI.service* restarts.

If *GI.service* is restarted before the “unnamed” project is saved with a new name, then the technically *unsaved* changes previously made to project “unnamed” will be refreshed to their default configurations, or lack thereof.

Ensure that any changes made to a default “unnamed” project are promptly saved with a unique name. You may overwrite an already existing project save file; Saving a project is the only way to avoid loss of configuration data.
- In **Configuration** tab of *GI.bench*, click on **New** in toolbar: By clicking on **New**, *GI.bench* will create a new instance of the default “unnamed” project mentioned in Method #1 above. Ensure that changes made to the default “unnamed” project are promptly saved as a new project with a unique name or overwrite an already existing project save file; this is the only way to avoid loss of configuration data.
- In **Configuration** tab of *GI.bench*, click on **Read** in toolbar: By clicking on **Read**, *GI.bench* scans any connected networks for compatible Gantner Instruments Test Controllers. If you connect to a Q.station X using this method, existing module configuration data is read from the Test Controller. Changes made to a project are only local to the PC until either written to the Q.station X to update existing configurations or saved to the PC to retain the off-line changes for future use.

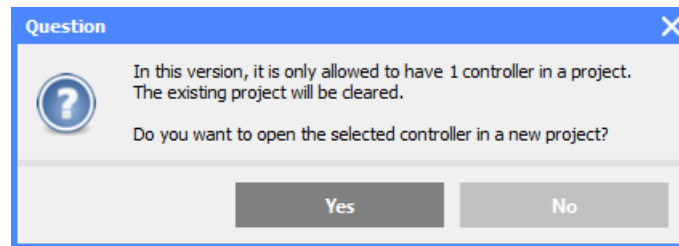

Fig. 6-2 Only one test controller per GI.bench project is possible

- ➔ As of *GI.bench* V1.3 Build 02, Online data is only available if the appropriate *system data streams* are created within a project.

When using **Read** to add a connected Q.station X Test Controller to a project, a prompt will request that you select data streams for visualization within the project (e.g., Fig. 6-3). Available data streams will be selectable in this window if they exist (i.e., at least one UART with connected modules must be readable). For instructions on how to connect Q.series XL modules to a Q.station X, refer to Chapter 5, *System Assembly & Setup*, page 37.

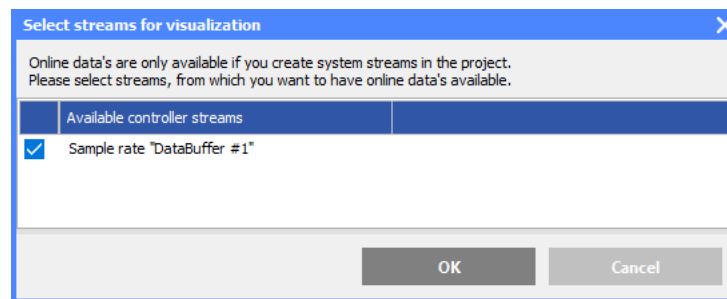



Fig. 6-3 Select data streams for Online visualization

After adding the necessary data streams to the project, the Test Controller selected via **Read** is displayed in a project tree.

The project tree structure displays only the connected (or found) Q.series XL modules and the existing variables within the system. Within the project tree are categories for system configuration such as *Data logging*, *Sample rates*, *System Variables*, *Physical variables*, *Virtual variables*, *CAN #1*, and *RS-485 interfaces*. The categories can be expanded and collapsed if they possess entries; Expand categories in a project tree by a clicking  as needed.

Tip

In *GI.bench*, each item within the project configuration tree can be clicked (i.e., to select), double-clicked (i.e., to open settings also accessible via context menu), and right-clicked (i.e., to access the context menu for additional options). Some settings are only accessible via the context menu. Use the context menu to either **Append**, **Insert**, or **Delete variable(s)** as needed.

Open the *Controller settings* window by double-clicking on the Q.station X within the *GI.bench* project tree or by selecting **Edit controller** in the context menu of the Q.station X (e.g., refer to Fig. 7-1, page 138).

Open the *Module settings* window by double-clicking on a desired Q.series XL module within the *GI.bench* project tree or by selecting **Edit module** in the context menu of the desired module.

Open the *Variable settings* window by double-clicking on a desired variable within the *GI.bench* project tree or by selecting **Edit variable** in the context menu of the desired variable (e.g., refer to Fig. 8-2, page 166).

! **IMPORTANT**

In *GI.bench*, a  is displayed next to any items within the project configuration tree that have received changes. To commit updated settings on the Q.station X Test Controller, in *GI.bench* select **Read** from the toolbar. Project files are saved to your PC automatically when written to the Q.station X Test Controller.

6.4

Establish a Connection

Adding a Q.station X to a *GI.bench* project establishes a connection between the Q.station X and your PC. A project in *GI.bench* contains all the information pertinent to the entire Q.series XL system such as the structure of the hardware, sensor types, I/O settings, and calculations used. This information can be downloaded from the Q.station X at any time within a new *GI.bench* project for reconfiguration and viewing Online values.

Procedure

1. Make sure that the installation of *GI.bench* on your PC is the most up-to-date version (at least *V1.3.2 B02*).
The most up-to-date version of *GI.bench* can be found in the **Downloads** section on our website. If necessary, install the most up-to-date version (see Section 6.6, page 131).
2. Start *GI.bench* and select **New**.
3. Right-click on **Project “unnamed” @myComputer** and select **Edit project** to access the *Project settings* window.
4. In the **Description** field, enter a name for the project, then click **OK**.
5. Click the top menu options **Read**. The controller network scanner window will appear.
➡ If this is the first connection you are establishing, you must grant *GI.bench* and all related programs access to the network (e.g., both network and PC firewall access; can require network administrator rights).
6. In this window, select the Q.station X from the list of available controllers to add it to the new project. The following buttons are available when attempting to connect to the Q.station X:
 - a) **Re-scan**; select if the Q.station X not available in the list and all potential points of communication failure have been checked. The factory default setting for the Q.station X is **DHCP enabled**.
 - b) **Enter manually**, allows you to attempt a direct connection with a Q.station X by entering the static IP address of the Q.station X; factory default static IP address of the Q.station X is 192.168.1.28.
7. In either case of the above, *GI.bench* will notify the user if incorrect network setting settings are detected on the connected PC, and in turn, will offer the user an opportunity to change the settings of the Q.station X to match accordingly (including the deactivation of **DHCP enabled**).
8. To troubleshoot a connection, make sure that a standard CAT5 or better Ethernet cable is plugged into the network interface on the Q.station X and the Q.station X is powered on.

9. Wait for the Q.station X test controller to appear in the list. If the Q.station X is not displayed in the window, verify the IP address set on the PC. Otherwise, confirm the network DHCP server has assigned a network address to the Q.station X. It may also be necessary to check the integrity and installation of the network cable(s) and whether the appropriate port on the network switch is active. Click **Re-scan** to try again.
10. Once the Q.station X is selectable, configuration changes can be made to the network settings of the Test Controller. Select the Q.station X and click **Change settings**, otherwise click **OK**.

The project window will populate with a tree for the Q.station X test controller and all connected Q.series XL measurement modules and other connected I/O.

With this *GI.bench* project, it is possible to make configuration changes and view the values of the measurement channels.

6.5

Synchronization of Q.station X Test Controller

Synchronization of up to 64 interconnected Q.series XL modules is possible with one Q.station X Test Controller, however, you can connect a Q.station X to additional Test Controllers, e.g., another Q.station X, in order to expand the system even further.

All synchronized modules operate synchronously with maximum jitter approximately $\pm 0.5\mu\text{s}$ across all modules. Synchronization cable transfers not just a clock signal, but also the date and time.

In each case connect the Gantner supplied Synchronization cable into both Q.station X Test Controllers. If synchronizing with a Q.station-101DT (i.e., Classic) or similar Test Controller, use a Synchronization cable with flying leads, and connect lead SyA with SyncA, and lead SyB with SyncB of the Q.station-101DT or similar controller.

There are various methods for synchronizing several *systems*, i.e., several *Test Controllers*; (refer to Fig. 6-4 on page 126):

1. Use the time signal in the Q.station X Test Controllers based on the IRIG standard (Inter Range Instrumentation Group) to synchronize all Test Controllers to one master controller.

The master controller (the device which is *not* configured as a slave, refer to Section 7.1.1.4, *Synchronization*, page 141) uses its internal clock for the date/time stamp (gray path in Fig. 6-4, page 126). For this type of synchronization (inputs SyA and SyB) you must lay synchronization cables between the Test Controllers; the maximum permissible length of cable used is 400m (total). The master controller transfers the time stamp through an RS-485 link to the other Test Controllers. This method achieves the best time synchronization with the smallest jitter (approx. $\pm 2\mu\text{s}$) between the individual modules, because the time information passes simultaneously to all Test Controllers.

2. Connect a radio receiver for time signals, e.g. for DCF77 which converts the received time signal to IRIG-B or AFNOR NF S87-500, to a Q.station X Test Controller, making it the master controller.

As master controller, the Q.station X then synchronizes all other Test Controllers using IRIG (orange colored path in Fig. 6-4) as with Variant 1. If it is not possible to connect the individual Test Controllers via synchronization cables or this is not desired, you can also connect a GPS receiver to each Test Controller (**Variant 2b**).

3. Connect an NMEA-0183 compatible GPS receiver (Global Positioning System) to a Q.station X Test Controller to, similar to Variant 1, synchronize all Test Controllers to one master controller.

With this method the time information of the GPS signal is evaluated instead of a pure time signal. In addition you can also process the position details of the GPS receiver in the system and assign the measurements (light blue path in Fig. 6-4). If it is not possible to connect the individual Test Controllers via synchronization cables or this is not desired, you can also connect a GPS receiver to each Test Controller (also to a Q.gate Test Controller) (**Variant 3b**).

4. You define a PC as an SNTP time server which can distribute the NTP time stamp to all Q.station X, Q.station Classic or Q.gate Test Controllers (dark blue path in Fig. 6-4). However, Q.gate Test Controllers are not compatible with *GI.bench*.
5. You can use the EtherCAT port on extended versions of the Q.station X Test Controllers (e.g., XE or XTE) for the synchronization of the Test Controller (via Distributed Clock).

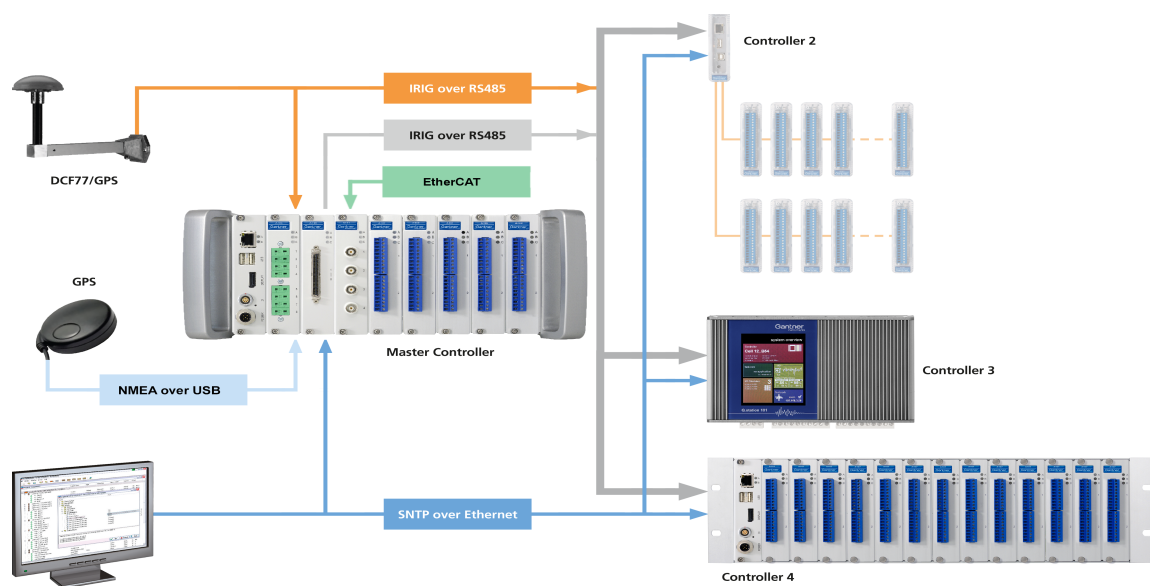

Fig. 6-4 Possible types of time synchronization; the locations of lines depicted on products pictured are not relevant

! IMPORTANT

The maximum length of the synchronization cables on SyA and SyB is 400 m.

The absolute accuracy of the time information depends on the method used. If you do not want to use or cannot use any time synchronization lines, e.g. because the spacing of the systems is too large, you must expect greater deviations. In **Variante 2b**, the deviations lie in the range from a few milliseconds up to about 100 milliseconds, but this depends on various factors, e.g. how often the time information is received. In **Variante 3b**, the time accuracy of the GPS signal is decisive, which is only approx. 1 second absolute.

The fourth method uses, e.g., the SNTP protocol (Simple Network Time Protocol) used in the Microsoft Windows operating system to transfer the date and time via Ethernet. However, the individual Test Controllers must always query the time server in order to be able to synchronize their times with the time server. The achievable accuracy is therefore not as good as for the first three methods. If required, you can also set up a (full) NTP time server on a PC and synchronize it with a time server in the Internet.

! IMPORTANT

When attempting to synchronize a Q.station X or Q.station Classic Test Controller to a Windows-based NTP server, Windows Defender Firewall will block NTP packets by default if activated. Ensure to either switch OFF Windows Defender Firewall or open the UDP port 123 on Windows Defender Firewall or equivalent.

You will find further information about NTP time servers at:
<http://www.meinberg.de> (time server program download as well)
and at:
<http://www.pool.ntp.org>.

The time accuracy is then only dependent on the change in the response times in your network.

The fifth method receives the time signal from a EtherCAT master. Here, the time delay of the signal is fed back to the master which then calculates a new time signal. Time resolution of the signal is 1 μ s. The start date of this time calculation is 1.1.2000.

If you wish to combine several synchronization methods, the best possible options are the following:

1. Hardware synchronization of the Q.station X, EtherCAT, IRIG-B or AFNOR using a time signal, e.g. DCF77)
2. Time signal from GPS (NMEA-0183)
3. SNTP

The configuration of the synchronization in all cases occurs via the program *GI.bench*. Apart from synchronization via SNTP (Section 7.1.3.5, page 149) you set the type of synchronization used via the Q.station X context menu: **Edit controller > Synchronization > Type**; refer to Section 7.1.1.4, page 141.

6.5.1

Connecting Radio Receivers for Time Signals

The Q.station X can process the following time signals:

- AFNOR NF S87-500
- IRIG B003
- IRIG B005

Depending on the output signal of your receiver you basically have the following methods:

1. The receiver, e.g. for DCF77, is connected to the digital inputs of the Q.station X Test Controller (DI Interface, connections *DI1* and *GND*; refer to Fig. 4-2, page 24).
The variant is suitable if the receiver outputs signals at a TTL level. This is the case, for example, with *Hopf* clocks (IRIG-B003 or IRIG-B005 depending on type) with TTL output (e.g. module 4465 with interface version 5).
2. The receiver is connected through the sync input (Sync port, connections *SyA* and *SyB*; refer to Fig. 4-5, page 25). The variant is only possible when the receiver has an RS-485 interface, because the sync input uses this interface.

Specify the type of synchronization used via Q.station X context menu: **Edit controller > Synchronization > Type**; refer to Section 7.1.1.4, page 141.

6.5.2

Connect a GPS Receiver

NMEA-compatible or *Garmin* GPS receivers can be connected to the Q.station X Test Controller via the USB interface. If your device only has one RS-232 interface, you can use a commercially available RS-232-to-USB adapter.

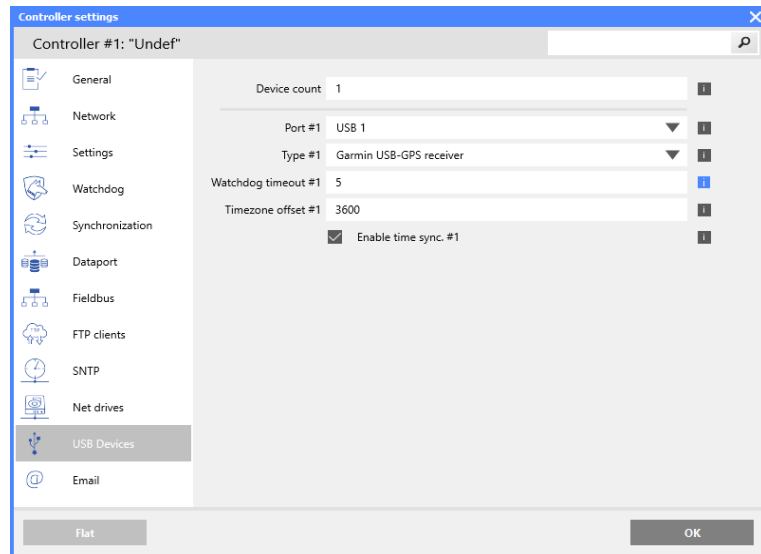

Fig. 6-5 Settings for a GPS receiver from Garmin

Here, define the interface settings (for the connection refer also to Fig. 4-1, page 23). If no new time information is received within the time period specified for the **Watchdog timeout #1**, the Q.station X uses the next available synchronization method.

Evaluating Position Data

Use the variable **GetPositioningData** to evaluate the individual data items of your GPS receiver; refer to Fig. 6-6. You need one dedicated variable for each item of data supplied by your receiver. The various messages which contain the relevant value are listed in explanations of the **Functions**, as shown in Fig. 6-6, by selecting the .



Fig. 6-6 Output of the latitude (Parameter = 1) via variable type Arithmetic; the NMEA receiver is connected to USB1 (Parameter = 0; Source NMEA)

6.6

Installing *GI.bench*

- ➔ We recommend closing all open programs before installation. Administrator rights will be required for installation.

The latest version of *GI.bench* is available on our website www.gantner-instruments.com in the **Downloads** section. Use the search filter to navigate to the *GI.bench* file quickly.

Procedure

- Determine if your Operating System (OS) is *32-bit* or *64-bit*. Right click **Computer** > **Properties** (Fig. 6-7).
- Locate the appropriate download link based on your OS, i.e., *64-bit* or *32-bit*, and unzip the contents.
- Follow the instructions in the setup program to select the installation directory for the software.
GI.bench Setup.exe, if necessary, will re-create the directory you have defined and copy all files there.

The first time you start *GI.bench*, you have to specify a language for the program interface. To change language at any time, select **Settings** > **Language**.

GI.bench requires that a license number be entered in order to utilize the full software package. *GI.bench* license numbers are purchased and assigned to you when requested via email upon initial installation.

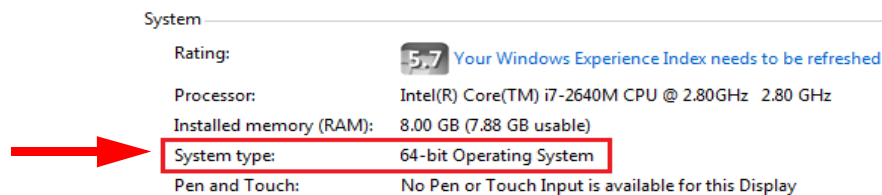

Fig. 6-7 Determine the type of operating system of connected PC

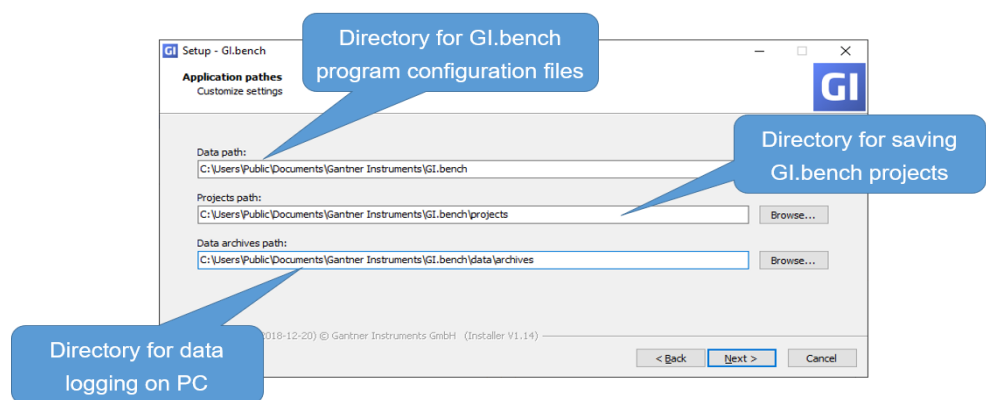

Fig. 6-8 Specifying *GI.bench* directories during initial program installation; can edit via the *GI.service* context menu

6.7

Ethernet on the PC

This chapter details the various settings you may need to adjust on your PC to establish a connection with the Q.station X test controller. The screenshots provided within Chapter 6 are from both Windows 7/8 and Windows 10. The menu selections that would otherwise be made in other versions of Windows would be similar in name and context. Should you ever get stuck despite following the instructions within this chapter, contact Gantner Instruments or your domestic Gantner Instruments Sales and Service location for further assistance.

6.7.1

Determine the IP address and subnet mask of the PC

In Windows 10, open the **Network and Internet Settings**.

In Windows 7 or 8, open the **Network and Sharing Center**, e.g., via  at the bottom right of your screen in the taskbar.

In Windows 10, click **Open Network and Internet Settings** and **Change Connection Properties**.

In Windows 7 or 8, click on the **LAN connection** (name may vary) that is connecting the test controller to the PC (Fig. 6-9, page 133). In the following status window (also in Fig. 6-9, page 133), click on **Details**.

The current IP address is displayed in the next window under **IPv4 address**.

The subnet mask determines which addresses are reachable from the PC, i.e., only addresses whose digits are identical at the locations containing 255 in the subnet mask can be reached. The IP addresses of the PC and the Q.station X test controller should be in the same Ethernet segment (only the last digit grouping of the IP address should differ); otherwise, the subnet mask must be 255.255.0.0 so that the last two groups of digits in each address may be different. In Windows 10 you can see the subnet mask if you access the status of the LAN connection from the **Network and Sharing Center** and click **Details**.

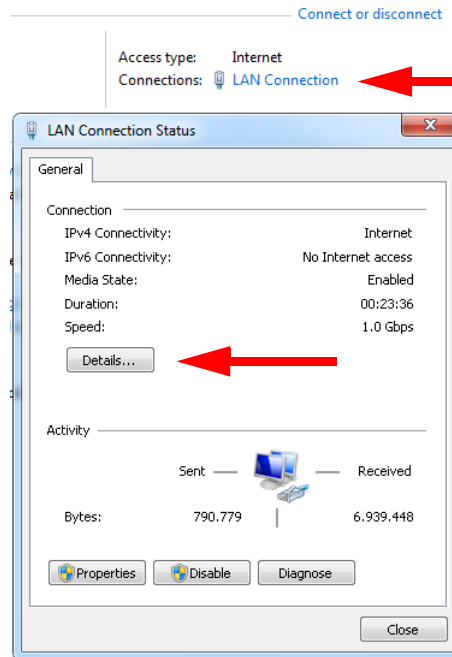

Fig. 6-9 View or change the IP address of the PC in Windows 7/8

Example 1

Subnet mask 255.255.255.0, IP address 192.168.1.26

Only addresses that begin with 192.168.1.x will be reachable (i.e., the first three groups of numbers must be identical, only the fourth denoted by “x” may differ from one another).

Example 2

Subnet mask 255.255.0.0, IP address 192.168.1.26

Only addresses that begin with 192.168.x.x will be reachable (i.e., the third and fourth groups of numbers denoted by “x” in the IP addresses of PC and Q.series XL may differ from one another).

6.7.2

Set the IP address of the PC

If you want to connect directly to a test controller, you must assign the PC a static IP address.

- ➔ We recommend setting up a static IP address on your PC, as this generally does not negatively impact network connectivity of the PC for typical use cases. If you already have an *alternative configuration* for your network, you must note the existing settings to restore them after completing the configuration process on the Q.station X test controller.

In Windows 10, open the **Network and Internet Settings**.

In Windows 7 or 8, open the **Network and Sharing Center**, e.g., via  at the bottom right of your screen in the taskbar.

In Windows 10, click **Change adapter settings**. Right-click on the **LAN connection** (the name may be different), which connects the test controller to the PC and select **Properties** (requires administrator rights).

In Windows 7 or 8, click on the **LAN connection** (the name may be different) connecting the test controller to the PC (Fig. 6-9, page 133). In the following status window, click on **Properties** (requires administrator rights).

Then highlight **Internet Protocol Version 4** and click **Properties** (see Fig. 6-10).

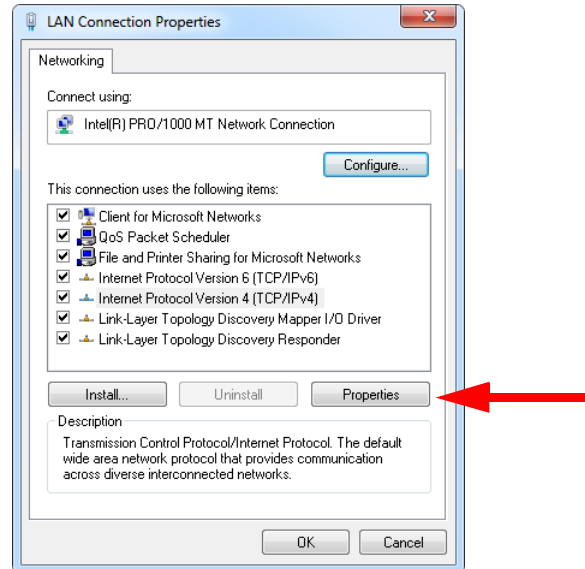

Fig. 6-10 Properties of the LAN connection

Then go to the **Alternate Configuration** tab and specify an IP address (e.g., 192.168.100.5) and subnet mask (e.g., 255.255.255.0) for the PC (see Fig. 6-11, page 134).

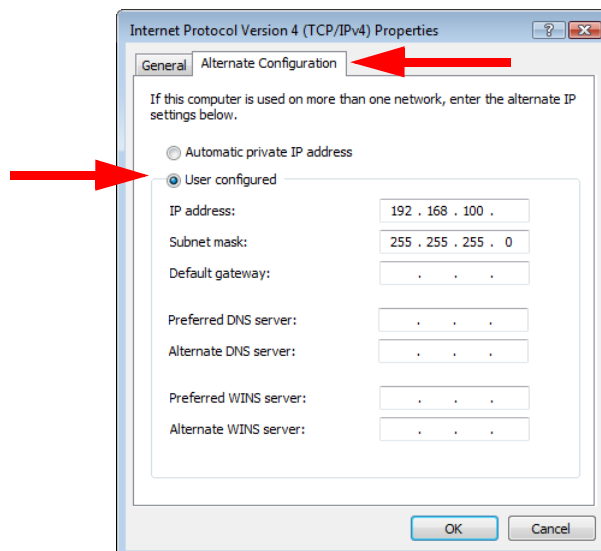

Fig. 6-11 Specifying the IP address and subnet mask for an alternative (temporary) configuration

6.7.3

Allow Access to the Network (Windows Firewall)

Most modern PCs have a firewall installed, which monitors the PC's access to a connected network and vice versa. Therefore, you must enable access to the Q.station X test controller and any connected I/O modules, otherwise you will not be able to connect via Ethernet. Usually upon the first connection attempt, you will receive a prompt similar to that shown in. Click **Unblock** or **Allow access** to allow the connection (Fig. 6-12).



Fig. 6-12 Allowing administrators access for GI.bench components during initial program installation, e.g., gibenchui

! IMPORTANT

You must have administrator privileges on the PC to be able to allow network access. Otherwise, ask your administrator to allow access. You must enable all programs related to *GI.bench* used to connect to the Q.station X test controller over Ethernet.

7

Configure the Q.station X

To make configuration changes, you must first create a new *GI.bench* project and establish a connection with the Q.station X Test Controller; refer to Chapter 6, *Connect Q.station X to a PC*, page 119 to learn how to establish a connection with Q.station X. Possible connection types for configuration of the Q.station X Test Controller includes a direct network interface (e.g., Ethernet), RS-485 serial interface (e.g., USB), or a TCP-IP based connection via a web browser (integrated web server). If a connection of any type is already established, this chapter is applicable to you.

This chapter details the most important settings and procedures related to the Q.station X Test Controller. Several methods exist for accessing the various settings windows detailed in this chapter. Certain settings can be only be accessed via the *context menu*. Right-clicking brings up the *context menu*.

The following is a basic description of the general procedure for configuring Q.station X:

Basic Procedure

1. Establish a connection between the PC and Q.station X, see Chapter 6, *Connect Q.station X to a PC*, page 119.
For measurement with a Q.series XL system to be possible, only basic configurations on the test controller are necessary. Later you may need to define additional settings, e.g., system variables and memory settings as needed.
2. Begin configuration in *GI.bench* by double-clicking on the desired Q.station X within the project configuration tree.
3. Configure the analog variables for sensors to be connected. Ensure scaling settings are appropriate in order to obtain meaningful data from the measured physical quantities. If applicable, define calculations, digital inputs/outputs, alarm monitoring, and other virtual variables.
4. Designate which data should be recorded and how it is to be recorded; see Chapter 9, *Record Data with Loggers*, page 181.
5. Activate the new configurations in the Q.series XL system by writing the project configuration changes to the Q.station X.

i Tip

In *GI.bench*, each item within the project configuration tree can be clicked (i.e., to select), double-clicked (i.e., to open settings also accessible via context menu), and right-clicked (i.e., to access the context menu for additional options). Some settings are only accessible via the context menu. Use the context menu to Append, Insert, or Delete variables and modules as needed.

7.1

Basic Settings in *GI.bench*

The following sections detail only the most important settings for general use, i.e., for measurement to be possible; please note that additional settings are explained in other chapters throughout this manual, but are clearly referenced within this chapter.

Covered topics in this chapter include settings such as naming the Q.station X (i.e., Location), activating PAC kernel mode for automation, plug-ins for custom functionality, as well as options for buffer pre-initialization, and digital switching thresholds. Controller settings such as for Watchdogs, Lifesignal, the slave interfaces, host interfaces, serial interfaces, USB devices and the baud rates of the Q.station X Test Controller are reviewed as well.

! **IMPORTANT**

In *GI.bench*, a  is displayed next to any items within the project configuration tree that have received changes. To commit updated settings on the Q.station X Test Controller, in *GI.bench* select **Read** from the toolbar. Project files are saved to your PC automatically when written to the Q.station X Test Controller.

7.1.1

Controller Settings

This settings window in *GI.bench* encompasses all the relevant settings for the Q.station X Test Controller, e.g., General settings such as controller location (name), Network for defining the IP address of the controller, and Life Signal settings.

Open the test controller settings window by double clicking on the Q.station X within the *GI.bench* project tree or by selecting **Edit controller** in the context menu of the Q.station X.

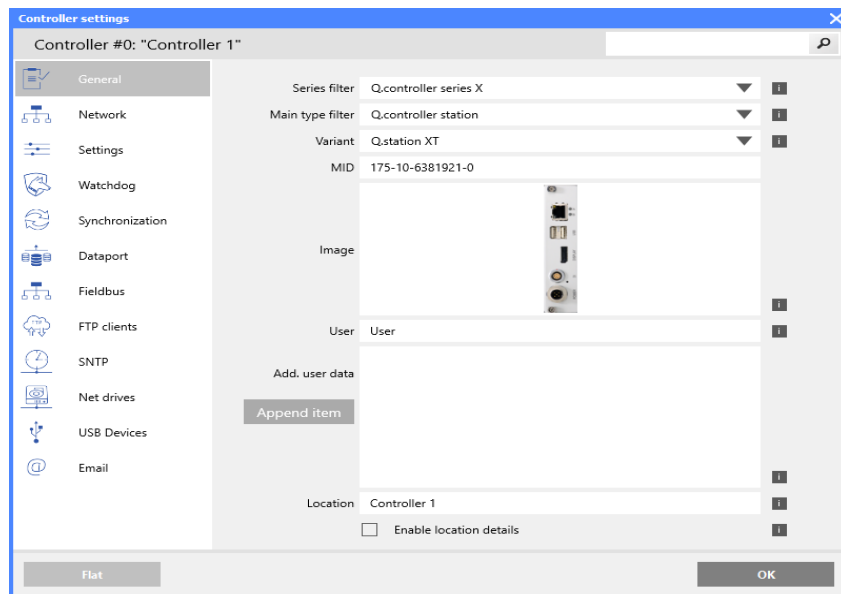
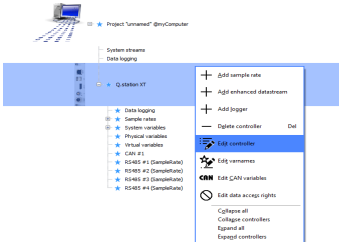

Fig. 7-1 Controller settings window for Q.station X in *GI.bench*

You can make all the necessary configuration changes to the Q.station X Test Controller from within this window. The settings are available in either a *Structured* view with alternating screens or a *Flat* view with drop down menus. Switch between views by clicking the button on the bottom left corner of the window, e.g., see Fig. 7-1, page 138. In either view, settings are organized into parameter groups. Expand each grouping by clicking on the name of the parameter group as needed.

The following section details the configurable fields within the *Controller settings* window organized by option categories.

7.1.1.1

General

Series Filter

Select the series of Test Controller, e.g., **Q.controller series X**.

Main Type Filter

Select the type of Test Controller, e.g., **Q.controller station**.

Variant

Select the specific device from the filtered list of products based on the above two filter selections made, e.g., **Q.station XT**.

User

Enter a name for the user here if necessary. The default is **User**.

Location

Enter a name for the test controller here, e.g., the location of the device. The default is **Controller 1**. By selecting the box "Enable location details", access to additional description fields is granted (e.g., country, city, and geographic coordinates).

7.1.1.2

Settings

Buffer Pre-init.(ialization) Type

In the **Fast fill** preset, any reading transmitted with a bit error results in an error: the reading becomes -1 (default **Fill pattern**) and the error counter is set. As a result, the test stand is usually stopped.

In the **Deactivated** preset, the previous measured value is also used for the current value. If the next measured value is correct again, normal measurement continues. The error is counted however no alarm is triggered.

In the **Slow fill** preset, for 2 seconds behaves as described in the **Deactivated** preset procedure, then behaves as in the preset **Fast fill**. The **Slow fill** preset ignores short disturbances.

Fill Pattern

Value used for a faulty measured value (**Buffer Pre-init. Type**).

PAC Kernel Mode

PAC functionality allows you to use the graphical programming software *test.con* to develop arbitrary functions for several measured variables and I/O, including but not limited to calculations, links, time and transfer elements and can be operated either automatically or manually (both independently from a PC).

Activated grants general data access (read and write) for *test.con* applications (for both *Real-time* and *UserSpace* kernels) to variables of the Q.station X. The default factory setting for the controller's PAC functionality is **Stopped**.

Plugin Mode

Defining this as **Activated** allows for the installation and usage of customer-specific programmed extensions (e.g., to read data from other systems such as ARINC or a Moog Test Controller). If plugins are necessary for your application, please contact Gantner Instruments or your domestic Gantner Instruments Sales and Service location for more details.

7.1.1.3

Watchdog

If the Q.station X stops responding, the watchdog is capable of restarting the Test Controller.

Watchdog Type

Enable (**Reset on retrigger timeout**) or disable (**Off**) the Watchdog feature. If enabled, additional configuration settings appear.

Watchdog Start Delay

The watchdog needs at least **30** seconds after system start (after measuring mode is initiated) to activate. You can extend the start delay period beyond 30 seconds here.

Watchdog Retrigger Time

The time period in which the Q.station X Test Controller must report to the watchdog in order not to trigger a restart. The minimum interval is **10** seconds. Extend the interval here for applications with slow measurements to save energy.

Lifesignal Type

Here you specify how the life signal should be generated. You can have a **Static** signal output which will change state only in case of an error, or you can use a **Dynamic** signal which will change state between high and low at a specified frequency.

Lifesignal Toggle Time

The frequency or half cycle time is entered here in seconds. The default is **0** seconds as there is not a required minimum value.

Lifes.(ignal) Output Variable

Selectable if the option for **Use variable as output** is enabled. The output variable (e.g., virtual variable outputs for Q.station X or any output variable of a Q.series XL system) to be used for the Lifesignal is selected here.

IMPORTANT

For both **Lifesignal Types**, you can select any combination of the additional conditions for how an error may or should be signaled. Note that the conditions change if you switch from **Static** to **Dynamic** (read text carefully); depending on the signal type that is selected, the available additional conditions are combined with either an **AND (Dynamic)** or an **OR (Static)**.

7.1.1.4

Synchronization**Type**

Select both the synchronization method to be used and the input interface type used for it.

If your device is to operate as a slave, i.e. if you connect another Test Controller that provides the time sync to the sync port on the Q.station X (Fig. 4-1, page 23) or if you connect a radio receiver with an RS-485 output for the necessary time signal, then specify **Q.sync via RS-485** here.

! IMPORTANT

The maximum permissible total length of the synchronization cable used for the Q.station X sync interface is 400m.

Specifying **EtherCAT DC Time** (distributed clock) is only valid if an EtherCAT master is present and connected via the EtherCAT port available on an extended version of the Q.station X.

If using the setting **None**, the Test Controller operates with the internal time (and as a master for connected Test Controllers).

If you want to synchronize via SNTP, you must specify the time server via the Q.station X context menu: **Edit controller > SNTP > Mode > Standard NTP** or **Legacy SNTP**; see Section 7.1.3.5, page 149.

Div. Base Cycle Freq.

The **Div. Base Cycle Freq.** is the *base sample rate* of the Q.series XL system and defines *Sample rate #1* (Data buffer #1; default name: *SampleRate*). All other sample rates must be equal to or less than the sample rate of the primary data buffer (i.e., the first UART must be as fast or faster than subsequent UARTs).

Div. Base Cycle Freq. also provides the synchronization basis for all other sample rates, i.e., sample rates are synchronized to be the same as or scaled to be lower than **Div. Base Cycle Freq.** such that all measurements across all data buffers are taken at time points when measurements take place for *Sample rate #1*.

➔ The above does not apply to the **Synchronization source > External** operating mode.

Sample rate #1 will always be limited to the **Synchronization source > Internal** operating mode as it is the base sampling rate of the system.

Therefore, in order to adjust the sample frequency of *Sample rate #1* (data buffer #1), access the *Controller settings* via this setting (e.g., refer to Fig. 7-2, page 142).

Div. System Cycle Freq.

The system cycle frequency provides the (internal) clock for the processing of virtual variables and *test.con* applications in the Q.station X. The cycle frequency can be set slower or equal to the highest sample rate. The maximum cycle frequency is 10kHz; it determines the system load.

! **IMPORTANT**

When changing *Sample rate #1* via **Div. base cycle freq.** (e.g., see Fig. 7-2), the **Div. System cycle freq.** changes proportionally to *Sample rate #1*. For example, with a base cycle frequency of 10,000Hz and a system cycle frequency of 1000Hz, reducing the base cycle frequency from 10,000Hz to 1000Hz will reduce the system cycle frequency from 1000Hz to 100Hz, as well).

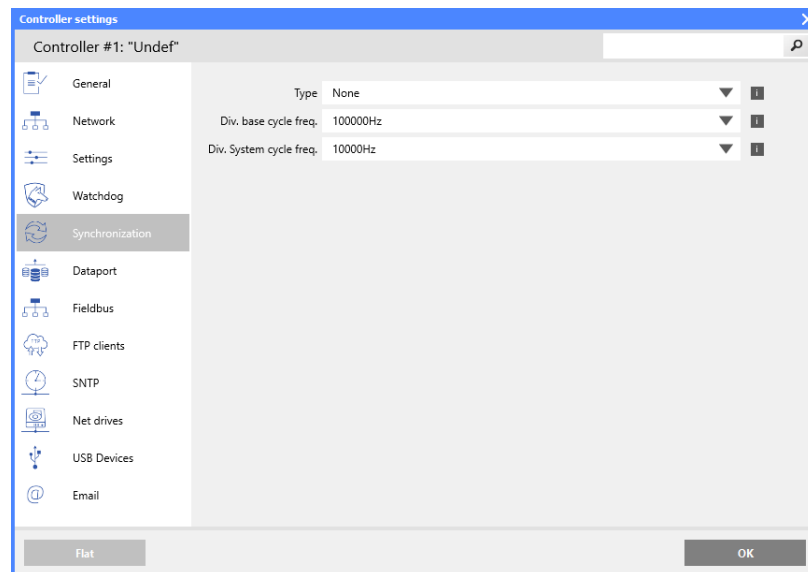

Fig. 7-2 Configure the sampling rate of Data buffer #1 via the Synchronization Controller settings in GI.bench

7.1.2

Adapter Settings: UARTs (RS485 #1 to #4), CAN #1

Methods of data transmission with the Q.station X, e.g., an RS485 interface (UART), are called adapters in *GI.bench*. There are five adapters available in total for the Q.station X: four RS485 interfaces (UARTs), a CAN bus interface or CAN FD bus available via USB dongle. Each adapter has its own *Adapter settings* window accessible by double-clicking on the adapter in the configuration tree or by selecting **Edit adapter** in a desired adapter's context menu.

7.1.2.1

RS-485 (UART) Interfaces (RS-485 #1 to #4)

Select the required baud rate (transmission speed). The standard default setting for new *GI.bench* projects is **24M(Baud)**.

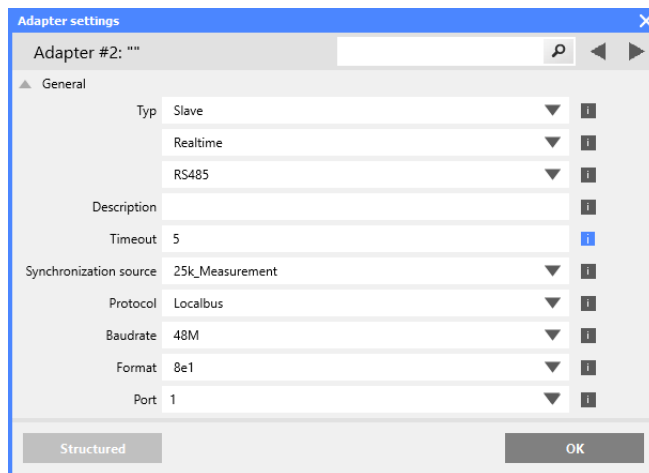

Fig. 7-3 48MBaud defined via RS485 #1 Adapter settings

The maximum possible speed depends on whether cable is used, and if so, the overall length and quality of the cable connected to the relevant interface. With high quality cable, maximum achievable distances per baud rate (and Gl.bench setting in bold) are:

Cable Length (meters)	Maximum Baud Rate
1000	< 500 kBd (500K and below)
100	< 1500 kBd (1M5)
20	< 6000 kBd (3M, 6M)
10	> 6 MBd to 24 MBd (12M, 24M)
0	< 48 MBd (48M)

Note that depending on the quality of the cable used (*capacitance per unit length, loop impedance, and characteristic impedance*) the achievable distances may be substantially shorter than listed above. In all cases, however, make sure terminating resistances are activated at the end of each UART (Section 5.2.4, page 42).

- ➔ Baud rate changes made to **RS485 #1** through **#4** automatically carry over to the modules connected to those interfaces.

Timeout

With a value > 0 the module error LED is activated if there is a lack of communication after this period.

7.1.2.2

CAN #1: CAN bus Interface

You can both read and send data over this interface. Maximum possible speed depends on the overall length of the cable used. Default **Baudrate** for the **CAN #1** adapter is **1M(Baud)**. To adjust the **Baudrate**, double-click on **CAN #1** to open the *Adapter settings* for CAN and adjust the value as needed.

Cable length in meters	Maximum baud rate
1000	< 50 kBaud
100	< 500 kBaud
50	< 800 kBaud
25	< 1 MBaud

! **IMPORTANT**

A change in the baud rate only affects the Q.station X; connected CAN devices must be set to the desired **Baudrate** separately.

Timeout

With a value > **0** the module error LED is activated if there is a lack of communication after this period.

7.1.2.3

Configure CAN or CAN FD bus via USB 2.0 Interface (Converter)

If required, you can use CAN bus interface converter, e.g., the *PCAN-USB adapter* from PEAK-System Technik GmbH (<http://www.peak-system.com>). If available, a variant for CAN FD is acceptable.

In Controller settings, within the **USB Devices** options, specify a **Device count** of at least **1**, select the USB port (**Port #1**) that the converter is plugged into, define **CAN node** or **CAN FD node** as the protocol (**Type #1**), and set the desired CAN **Baudrate #1** to be used (Fig. 7-4). If **CAN FD node** is selected, an additional option for **Data baudrate #1** appears with a selectable range of **2M(Baud)** to **12M(Baud)**.

Refer to Section 7.4.2, page 158 for details regarding how to configure single CAN signals, i.e., via the Q.station X CAN port.

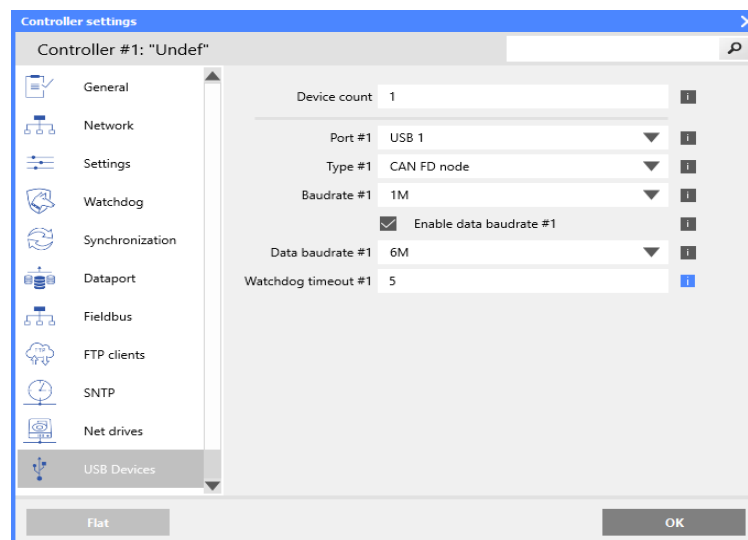

Fig. 7-4 Configuring a CAN FD node via a USB 2.0 interface

7.1.3

Host Interfaces

This section describes the various settings for communication via the available Modbus-TCP/IP and Ethernet interfaces.

For example, you can set **Email** notifications for a data logger and define **Net.(work) drives** that the Q.station X Test Controller can access allowing loggers to store data to a network drive, not just to local drives (e.g., internal SD, USB).

7.1.3.1

Fieldbus (EtherCAT)

The section contains the settings for the EtherCAT interface. Deactivate the interface (i.e., **None**) if you do not use **EtherCAT**.

! IMPORTANT

Via the context menu of the Q.station X, click on **Edit data access rights**, define which variables are to be available on the field bus via the *Assign read/write access rights settings* window. Activate the read access (**READ permissions**) in the **Field bus** column for the relevant variables (Fig. 7-5).

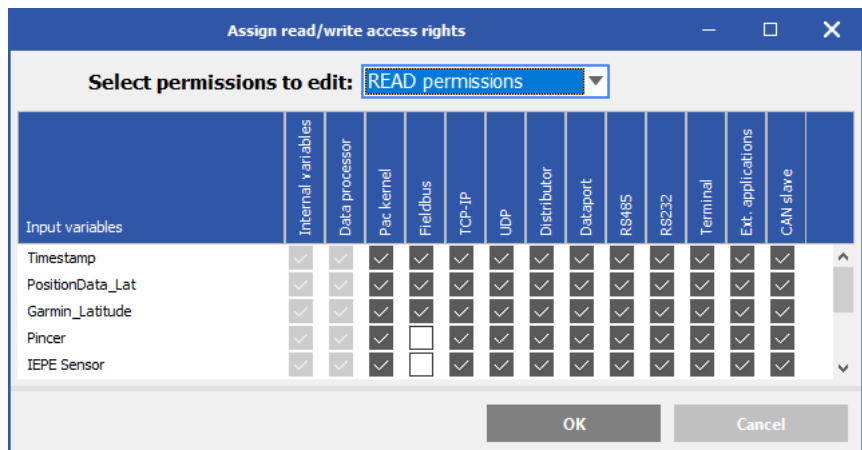

Fig. 7-5 Enable read access rights (permissions) for the field bus

Cycle Frequency Divider

This determines the transfer rate for the EtherCAT interface. The divider is required for high data rates (e.g., *Sample rate #1*) to avoid overloading the interface. The selectable value is actually the *resultant* cycle frequency after applying a frequency divider on *Sample rate #1*, i.e., the *actual data transfer rate of the EtherCAT interface*. The setting uses *Sample rate #1* as a reference and therefore cannot exceed the **Div. Base Cycle Freq.** but instead can reduce it if needed, e.g., with a *Sample rate #1* of **25000Hz** an *EtherCAT data rate* of **1000 Hz** is possible with a frequency divider of 2.5. In this case, the **Cycle frequency divider** field consists of possible reduced frequencies; selectable EtherCAT data transfer rate options range from **40s** to **25000Hz** in Fig. 7-6, page 146.

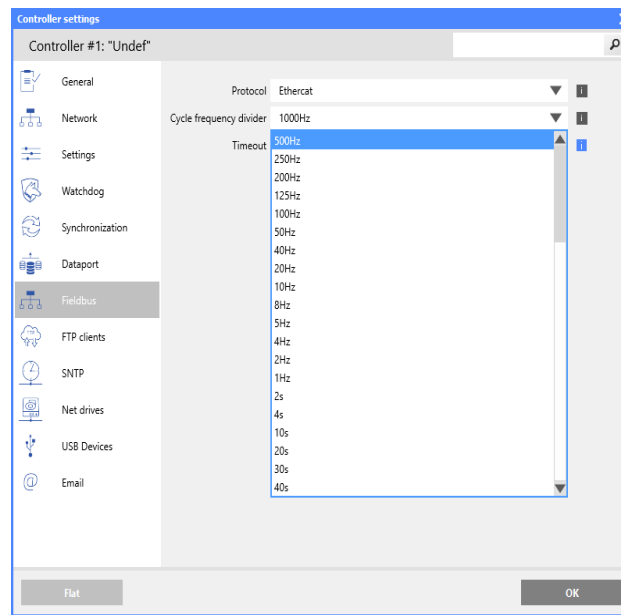

Fig. 7-6 Available resultant (divided) frequencies; i.e., actual data transfer rate for EtherCAT interface(s) available via the extended versions of the Q.station X Test Controllers

Timeout

With a value > 0 and with a lack of communication after this period the error status becomes active.

7.1.3.2

Network

Use this section to assign the fixed **IP address**, **Subnet mask**, and **Gateway address** of the Q.station X or to set it to **use DHCP**.

- ➔ The **IP address** is only effective when *no* DHCP server is used, i.e., **use DHCP** is *not* selected.

7.1.3.3

FTP Clients

Create new FTP client connections via: **FTP clients > Server settings > Connection count** (e.g., 1 in Fig. 7-7, page 147).

Client settings

Here you define an FTP server with which the Q.station X can connect as a client. You can then specify for a logger that created files are sent directly to the FTP server.

Check whether the settings for your FTP server at **Connection timeout**, **Timeout** or **Keep alive interval** have to be changed. Then specify how many (maximum ten) FTP servers you would like to set up. The FTP servers can also only differ due to the directories. The directory specified at **Directory #1** is created as a subdirectory to the directory released in the FTP server.

IMPORTANT

You have to set up an FTP server appropriately on a PC. There are many programs which facilitate this, e.g. *FileZilla*.

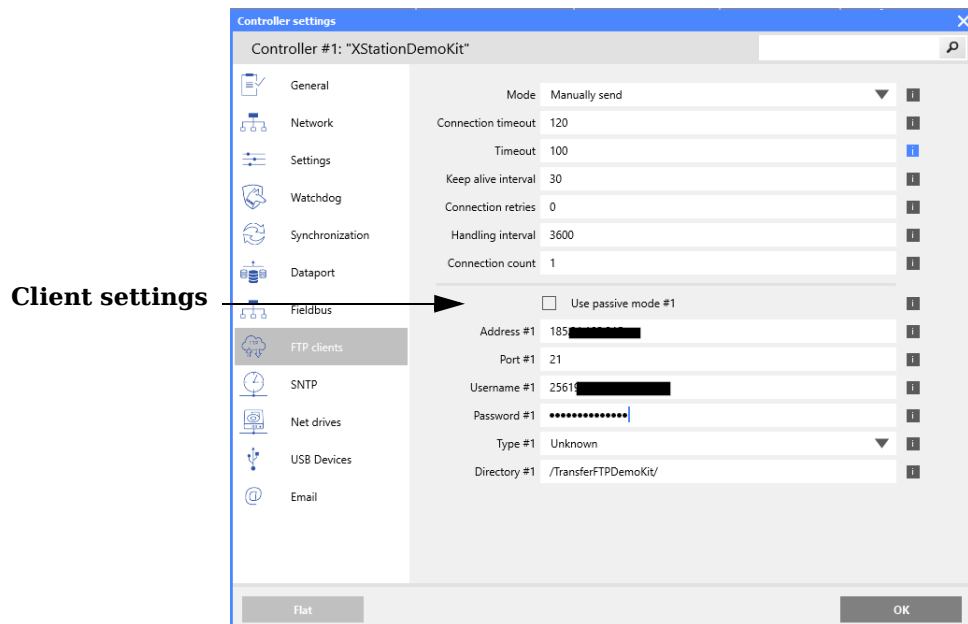

Fig. 7-7 Controller settings for setting up an FTP server such that the Q.station X can access it as a client for data storage

Use Passive Mode #1

With passive FTP, the client sends a command that causes the server to open and send a port and IP address back to the client. The client then uses a port over 1023 in addition to the port just submitted by the server. This technique is necessary if the server itself can not connect to the client (e.g., if the client is behind a router or if a firewall shields the client from access).

Type #1

Since the FTP server can reside on any operating system, a client would need to know what an answer to a query of the directory would look like. Unfortunately, that process is not standardized, yet. Depending on the operating system of the FTP server, the file information can be transmitted in various formats to the client, e.g., a certain format could allow the client to query the size of a file for example.

Selecting the **Unknown** format therefore only checks whether a file with the same name of the transferred file exists within the destination directory. It cannot check if the file is the right size, i.e., check if all data has been transferred successfully.

Directory

This option allows you to define a subdirectory on the FTP server. If you want to save the data of several loggers in different directories, simply create the same FTP server with different subdirectories, e.g., **/Data1** and **/Data2**.

! IMPORTANT

The spelling of **Directory #1** is *Case-Sensitive*.

i Tip

Within the specified directory you can have the logger create further subdirectories by using *placeholders* within the file name. The *placeholders* available for use are described in Section 9.4.1, *Data Logger Settings*, page 190 in **Name**.

7.1.3.4

Net(work) Drives

Using a network drive as the storage destination for a logger is an alternative to recording to a storage medium on the Q.station X internal storage (e.g., USB or SD). You can make the necessary configurations via this settings dialog (see Fig. 7-8).

Description #1

Enter here the name referenced in the logger to indicate this storage destination.

Address #1

Enter the IP address or name of the PC on which the directory resides (requires a DNS server).

Username #1

Enter the user name for the storage destination if the directory is shared.

Password #1

Password for the user name.

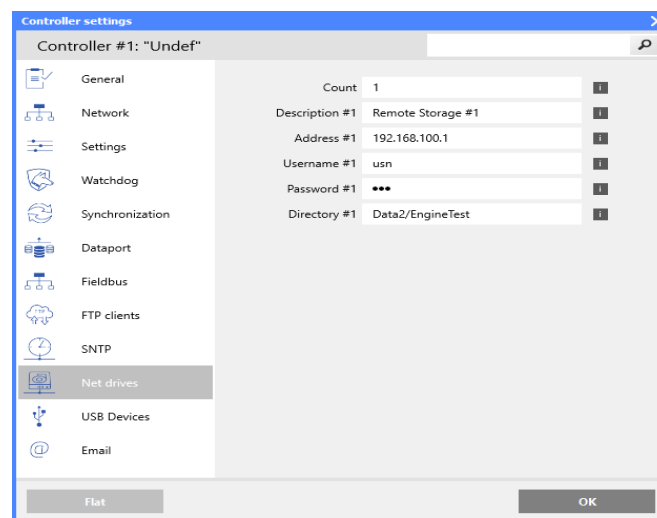

Fig. 7-8 Specifying network drives

Directory #1

Enter the directory path, e.g., **/Data2/EngineTest**, see Fig. 7-8. The path name corresponds to the directory path from the released folder.

For example, with a DataFiles sub folder in the Testing folder on the D:\ drive. The directory path will then be **/DataFiles**, as this is (at least by default) the name of the shared folder on the PC (**Address #1**) concerned.

7.1.3.5

SNTP

Select the desired NTP mode: **Standard NTP** or **Legacy SNTP**.

If Standard NTP is selected, enter the IP address of the NTP server in **Server address** if you want to set up a synchronization via NTP. If you select Legacy SNTP, included is an entry available for **Timezone offset**, up to **86400** seconds.

See Section 6.5, *Synchronization of Q.station X Test Controller*, page 125.

7.1.3.6

E-mail

In order for a logger to be capable of sending e-mails, you must specify entries for the **Email addresses**, **Email subjects**, and **Email bodies** fields shown in Fig. 7-9.

You can specify up to 10 separate Email addresses, subjects, and bodies. A recommendation for the **Email signature**, for example, specify the test bench location of the Q.series XL system. With a setup like this, the test bench location is always shown at the end of E-mails sent by loggers, i.e., clearly indicates the source of the E-mails.

For more information regarding configuring Email settings, refer to Section 9.4.3.7, *Send Data via E-mail*, page 196.

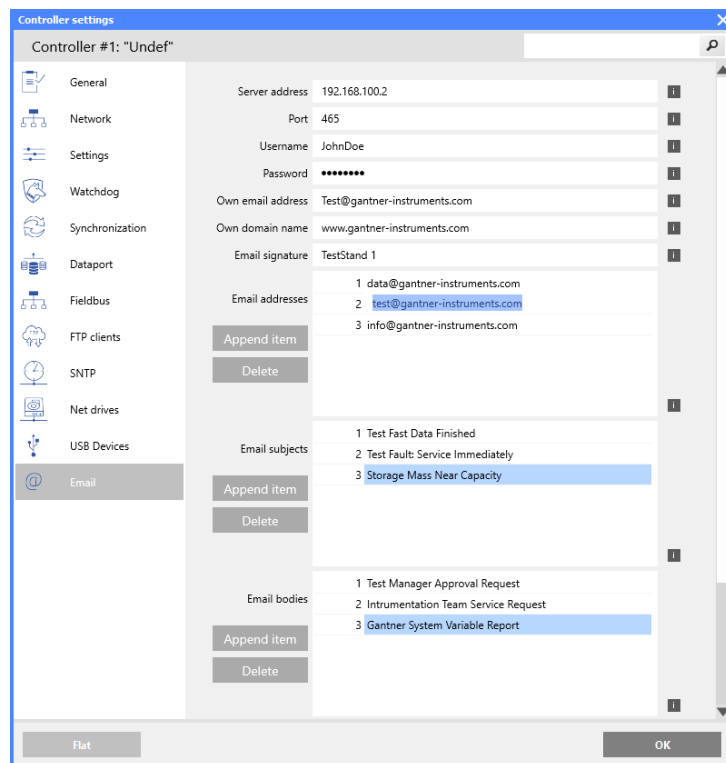

Fig. 7-9 User defined selections for E-mailed logger reports

7.1.3.7

Dataport

This section contains the settings for Modbus if this is being used via TCP/IP (Modbus-TCP/IP). Protocol options include **Modbus**, **Modbus (word swapped)**, and **ASCII**.

! IMPORTANT

If the Q.station X is used as a Modbus (either TCP/IP or RTU) slave, the user will need to know the Modbus registers and Variable Types for each desired channel. This information is available via **FILE > Calculate Statistics** by selecting each variable.

7.1.4

USB devices (GPS, Modbus-RTU, CAN)

In this section, you can define a special USB 2.0 compatible device in the USB port as shown on Fig. 4-1, page 23:

- Modbus-RTU interface via a converter,
- PCAN-USB adapter; refer to Section 7.1.2.3, *Configure CAN or CAN FD bus via USB 2.0 Interface (Converter)*, page 144,
- see above as well for CAN-FD-Bus,
- Garmin USB GPS device., e.g. Garmin GPS receiver or an NMEA-0183-compatible GPS receiver; refer to Section 6.5, *Synchronization of Q.station X Test Controller*, page 125.

Modbus-RTU interface

You can set up a Modbus-RTU connection via the Gantner *ISK 103, USB to RS-485* converter. The drivers for the converter are available in the Q.station X, but you can also connect many other conventional converters.

If **Modbus** or **Modbus (word swapped)** is the **Protocol**, then enter the data for your bus system within: **Controller settings > USB Devices > Device count > Type # > Modbus RTU master**, e.g., if the Q.station X is to be a **master**; for either master or slave, define the baud rate(s) to be used (Fig. 7-10, page 151).

In a configuration where the Q.station X is **master**, you can, for example, receive data from a *Meteo-40 Ammonit* data logger or transmit Modbus-RTU data via two *Phoenix RAD-2400-IFS* radio modules.

In a configuration where the Q.station X is used as a Modbus (either TCP/IP or RTU) **slave**, the user will need all the Modbus registers and Variable Types for each desired channel.

Define **Modbus** as the **Protocol** and specify the data for your bus system: Should the Q.series XL operate as **Master** or **Slave**, which baud rate is to be used, etc. (Fig. 7-10).

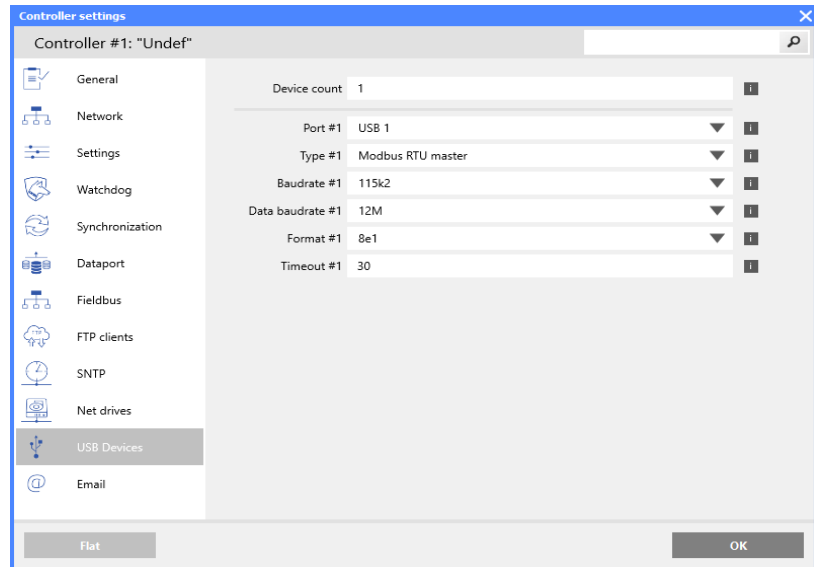

Fig. 7-10 Defining Modbus RTU master as the interface type for the ISK 103, USB to RS-485 serial converter

Format

Specify which parity is to be used: none (**n**), even (**e**) or odd (**o**). Eight data bits and one stop bit are always used so there are only the settings **8n1**, **8e1** (standard) and **8o1**.

Timeout

With a value > 0 the module error LED is activated if there is a lack of communication after this period.

The other settings can be carried out via the details for the virtual variables which are to receive data from this interface or send data to it; refer to Section 7.4.4, *Configuring Modbus RTU Signals*, page 162.

7.1.5

Sample Rate and Logger Settings

With the Q.station X you can configure up to four data buffers (i.e., *Sample rate #1* through *Sample rate #4*) for intermediate data handling and up to 20 data loggers (i.e., *Data Logger #1* through *Data Logger #20*) that can manage permanent storage of data to several storage destinations, at the same time.

On a data logger, you define which data is to be saved, how often and where. Logger settings are described in Chapter 9, *Record Data with Loggers*, page 181.

7.2

System (Time) Variables

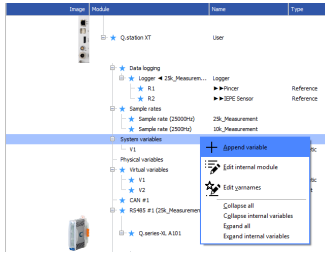

Below are descriptions for the basic settings regarding *System variables*. To add a system time variable to a *GI.bench* project, right-click on *System variables* to open the context menu and select **Append variable**. Enter the quantity of system variables you wish to add to the project and select **OK**.

! IMPORTANT

The default system variable **Timeinfo (V1)**, is a system cycle counter and must not be deleted. You can rename the variable **Timeinfo** if necessary. Time format is defined with **µs** resolution.

Under *System variables* in the project tree, specify additional time variables if you desire to use time formats other than the default system time. To do this, enter the *System variables* context menu and select **Append variable > Formula > System variables**. Select the desired system variable type (**Cycle counter** or **Time in EtherCAT DC format**) and define the desired output variable in **Available variables** (e.g., Fig. 7-11). After selecting the variable and click on **Format** to define the desired data format.

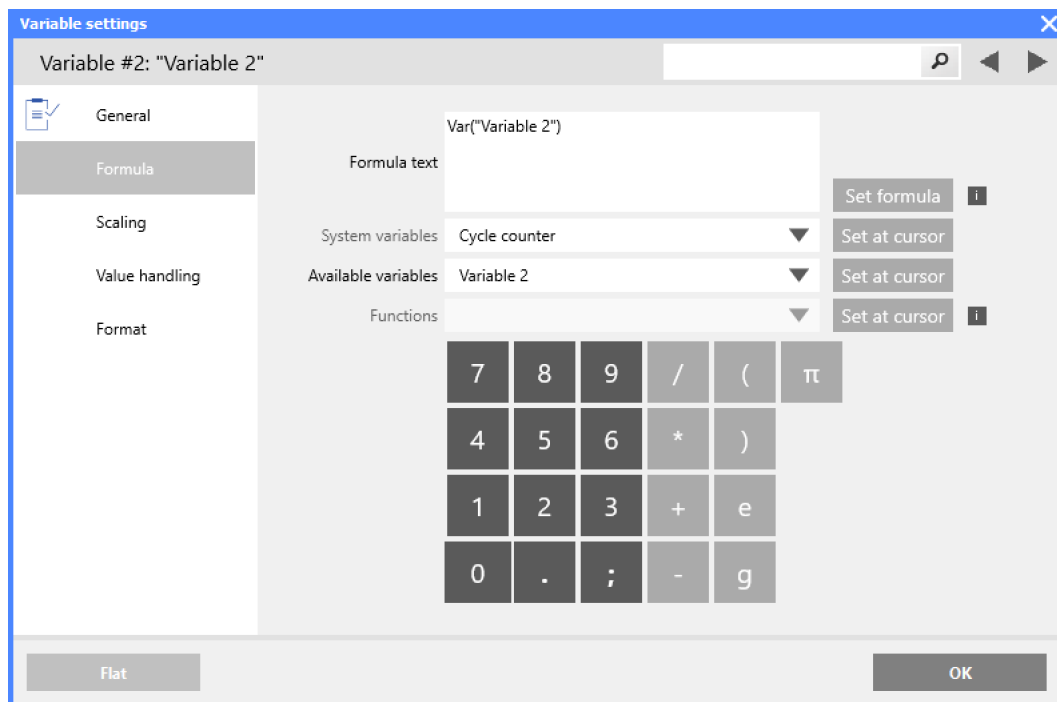
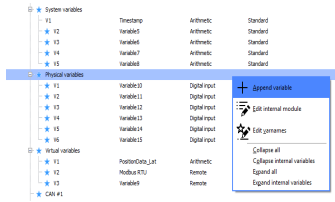

Fig. 7-11 Virtual variable formula settings for the OLE2 time format in *GI.bench*

7.3



Configuring Digital Inputs of Q.station X

Create variables for the digital inputs under *Physical variables* within the project tree in *GI.bench*.

Right-click on *Physical variables* in the project tree to access the context menu, then select **Append variable > Type > Digital Input**.

The Q.station X Test Controller supports up to six digital inputs. Additional digital inputs must be supplied via the Q.series XL measurement modules and are configured via *Variable settings* under the applicable modules.

7.3.1

Digital Inputs

Right-click on *Physical variables* in the project tree to access the context menu, then select **Append variable > Type > Digital Input**. Double-click the new physical variable to define settings.

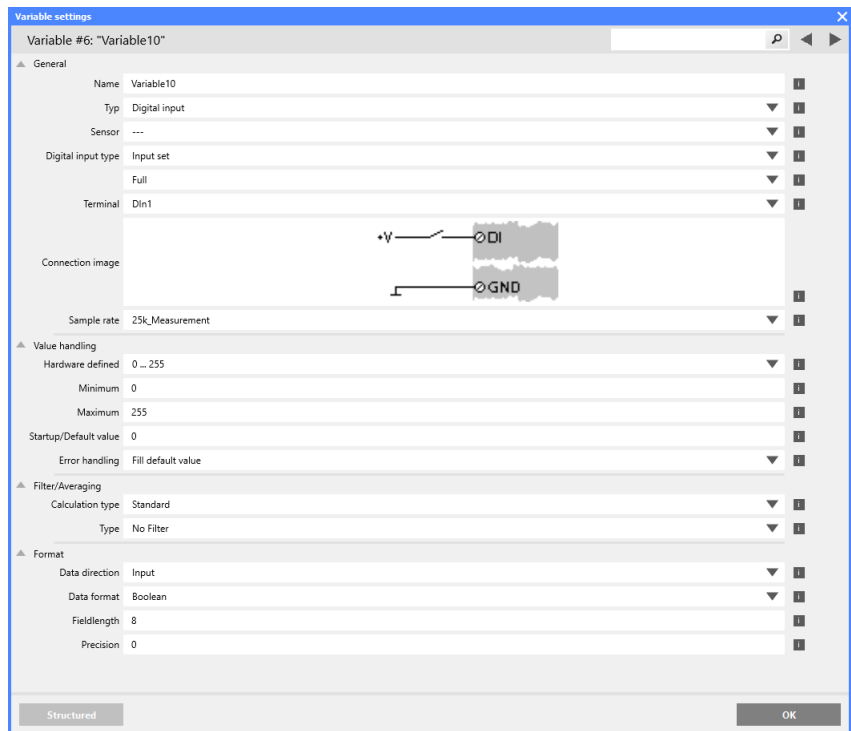

Fig. 7-12 Configuration dialog for a digital input

7.3.1.1

Internal Module Settings (DI Switching Thresholds)

By right-clicking the item *Physical variables* to access the context menu, then selecting **Edit internal module**, the *Internal module settings* are opened. In this window, you may define the **dig.(ital) input Level** as either **HTL** or **TTL**, e.g., see Fig. 7-13, page 154.

The Q.station X digital inputs can use **TTL level** (5V) or **HTL level** (24V). The switching thresholds are <1V and >3.5V (PNP) for **TTL** levels, <7V and >8V (PNP) for **HTL** levels.

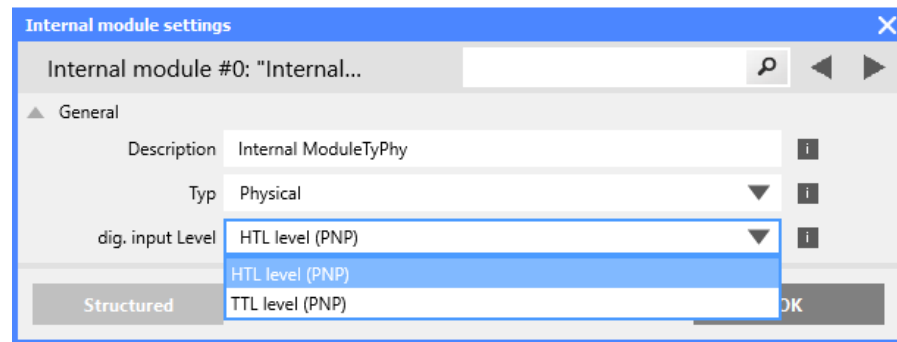

Fig. 7-13 Configuration dialog for a digital input

7.3.1.2

Digital Input Type

The following setting options determine how digital inputs are used and which additional settings will be required:

State

With this function it is only necessary to specify the connection terminal for the digital input signal. Leave all other settings on default because only the high or low levels are evaluated.

Frequency

You can choose between a **Standard** frequency measurement and **2-Wire** frequency measurement. The 2-Wire frequency may, e.g., enable you to detect direction of rotation through the sign of the rotational frequency (speed) using two digital inputs signals.

Counter

You can choose between a **Standard**, a forwards/reverse counter with two signals offset by 90° (**Quadrature > 2-Wire**), a forwards/reverse counter with a static direction signal for both forwards/reverse (**Up/Down** counter) and a forwards/reverse counter with two 90° offset signals and index signal (**Quadrature > 4-wire**), i.e. a reference signal at a zero position.

Time

Time > Duration measures the time between the low-to-high edges of a signal. **Time > Active** measures the time at the high level, whereas **Time > Passive** measures the time at the low level. With **Time > (PWM) Duty cycle**, a ratio between the time period at high level to the time period at low level is evaluated.

If required, you can specify a conversion factor between the pulse duration or the duty cycle of the input signal and the displayed value using **Scaling type**. Set the **Data format**, e.g. to **SINT32** (signed integer, 32 bit), **Field length** of **8** and **Precision** of **4 places** as the decimal point also counts as a *place*, i.e., for actual 3 decimal place precision, enter a **Precision** of **4**.

The following block diagrams provide an overview of the possible circuit configurations for the digital inputs on Q.station X:

Measurement of State, Time, Frequency or Duty Cycle or PWM (Pulse-Width Modulation), 1 signal

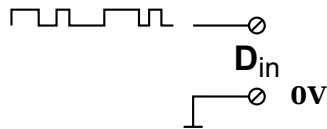

Up/Down Counter or Measurement of Frequency and Direction with Static Direction Signal, 2 signals

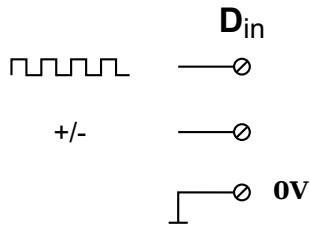

Measurement of Frequency and Direction or Up/Down Counter with 2-Channel Frequency Signal (90° phase delay)

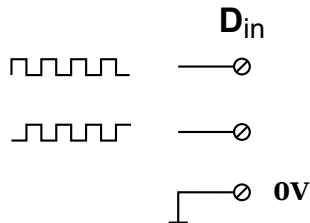

Measurement of Frequency and Direction or Up/Down Counter with 4-Channel Frequency Signal

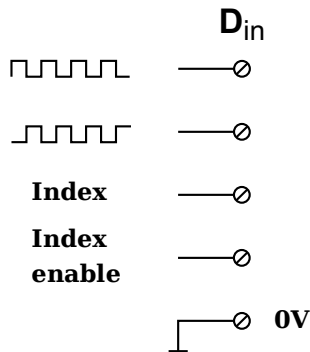

7.4

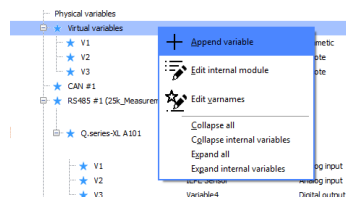

Virtual Variables

With *Virtual variables*, you can perform calculations, evaluate trigger conditions, make assessments, or define Modbus signals for input or output. Virtual variables can be output as measured values or you can link them to other virtual variables, measured values or digital I/Os. Virtual variables are also required if you want to use calculation results of a logger over Modbus-TCP/IP. The maximum processing speed for virtual variables is 10kHz.

! IMPORTANT

In *GI.bench*, a  is displayed next to any items within the project configuration tree that have received changes. To commit updated settings on the Q.station X Test Controller, in *GI.bench* select **Read** from the toolbar. Project files are saved to your PC automatically when written to the Q.station X Test Controller.

Below are descriptions for the basic settings regarding *Virtual variables*. To add a system time variable to a *GI.bench* project, right-click on *Virtual variables* to open the context menu and select **Append variable**. Enter the quantity of virtual variables you wish to add to the project and select **OK**.

7.4.1

Defining Virtual Variables

Right-click on *Virtual variables* in *GI.bench* to open the context menu and select **Append variable**.

Double-click on the new variable to open the *Variable settings* window where you can either specify a formula for computation, define an event to be monitored (i.e., for a trigger), or specify the data format to be used (Fig. 7-14, page 157).

In any case, define the variable name via **Name** and assign the variable to the desired data buffer via **Sample rate**. The variable **Type** can be defined as either **Arithmetic**, **Setpoint**, or **Remote**.

Arithmetic

Used for arithmetic calculations, i.e., enables the **Formula** field.

Setpoint

Used as a destination variable for formula calculations (e.g., an FFT processor resultant value) and can also be defined manually.

Remote

Used for **CAN** (e.g., Section 7.4.2, page 158), **Loggers** (e.g., Section 7.4.3, page 159), and **Modbus-RTU** (e.g., Section 7.4.4, page 162).

To define an arithmetic calculation, select **Arithmetic** for **Type**. By default, **Formula text** is defined as **Var("Variable1")**, e.g., if the virtual variable is named "Variable1". This formula text will result in the virtual variable reporting the value of Variable1, i.e., itself. Therefore, if calculations are desired, **Formula text** must be cleared for the desired formula(s) to be entered instead.

Once the Formula text has been cleared, select a desired formula from the drop down menu in the **Functions** field. With a desired function selected, click on **Set at cursor** to input the function into **Formula text**. Next, you must define the input parameter (i.e., variable) within the new function entry in **Formula text**.

Select the desired variable from **Available variables** and select **Set at cursor** to enter the variable into the input parameter as mentioned above. To commit a **Formula text**, click **Set formula**.

If **Event** settings are available after clicking **Set formula**, define **Event on host** for manual activation and **Event on variable** for either manual or automatic activation. Similarly, if Reset settings are available after clicking **Set formula**, define **Reset on host** for manual activation and **Reset on variable** for either manual or automatic activation (e.g., Fig. 7-14, page 157).

Anytime '**... on host**' is selected, the selected functionality will be available for manual activation via a button available in the **Data acquisition** tab in *GI.bench*.

When done, close *Variable settings* window by clicking on **OK**.



Fig. 7-14 Defining an arithmetic virtual variable with reset on host

7.4.2

Defining CAN Signals

To add and define CAN signals within a *GI.bench* project, create a **Remote** type virtual variable and set **Remote type** to **CAN** (e.g., Section 7.4.1, page 156 for details regarding defining the **Type**).

7.4.2.1

Defining Single CAN Signals

In the context menu for virtual variables select **Append variable** > **Type** > **Remote** > **Remote type** > **CAN**. You can change the name of the variable and enter the CAN parameters (Fig. 7-15).

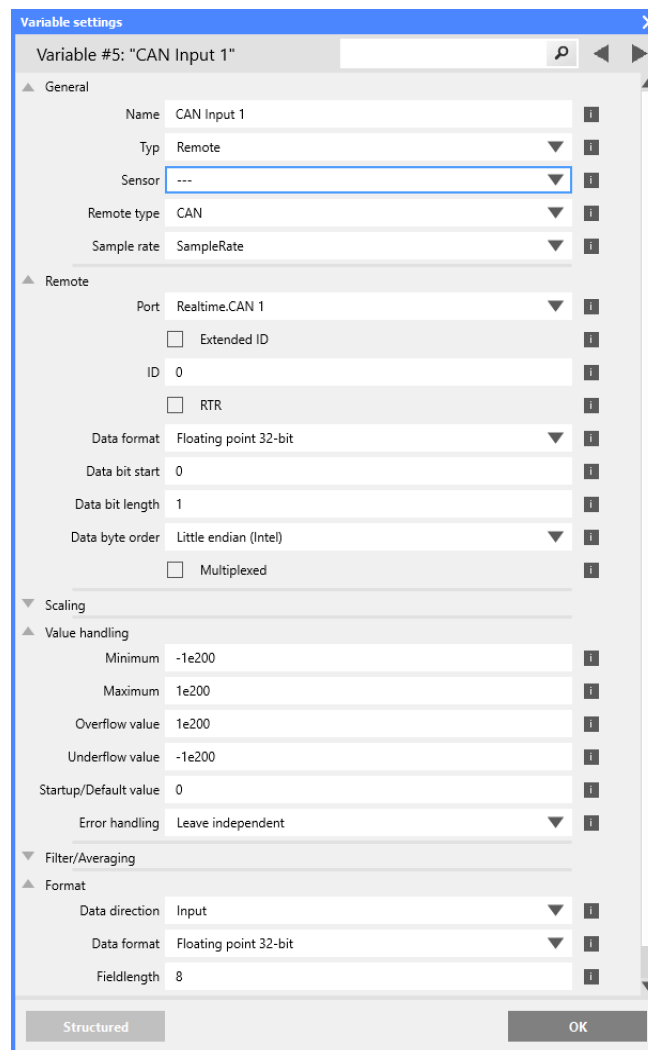

Fig. 7-15 Example of a CAN signal

For CAN FD signals, the USB 2.0 interface must be used in conjunction with a CAN FD to USB converter.

Refer to Section 7.1.2.3, *Configure CAN or CAN FD bus via USB 2.0 Interface (Converter)*, page 144 for more details.

7.4.3

Creating Logger Status Variables

A virtual variable can be utilized to determine logger status.

In the context menu for virtual variables select **Append variable > Type > Remote > Remote type > Logger**. You can change the **Name** of the variable and **Value state type** (Fig. 7-16). At least one logger must exist for a logger status variable to be fully defined.

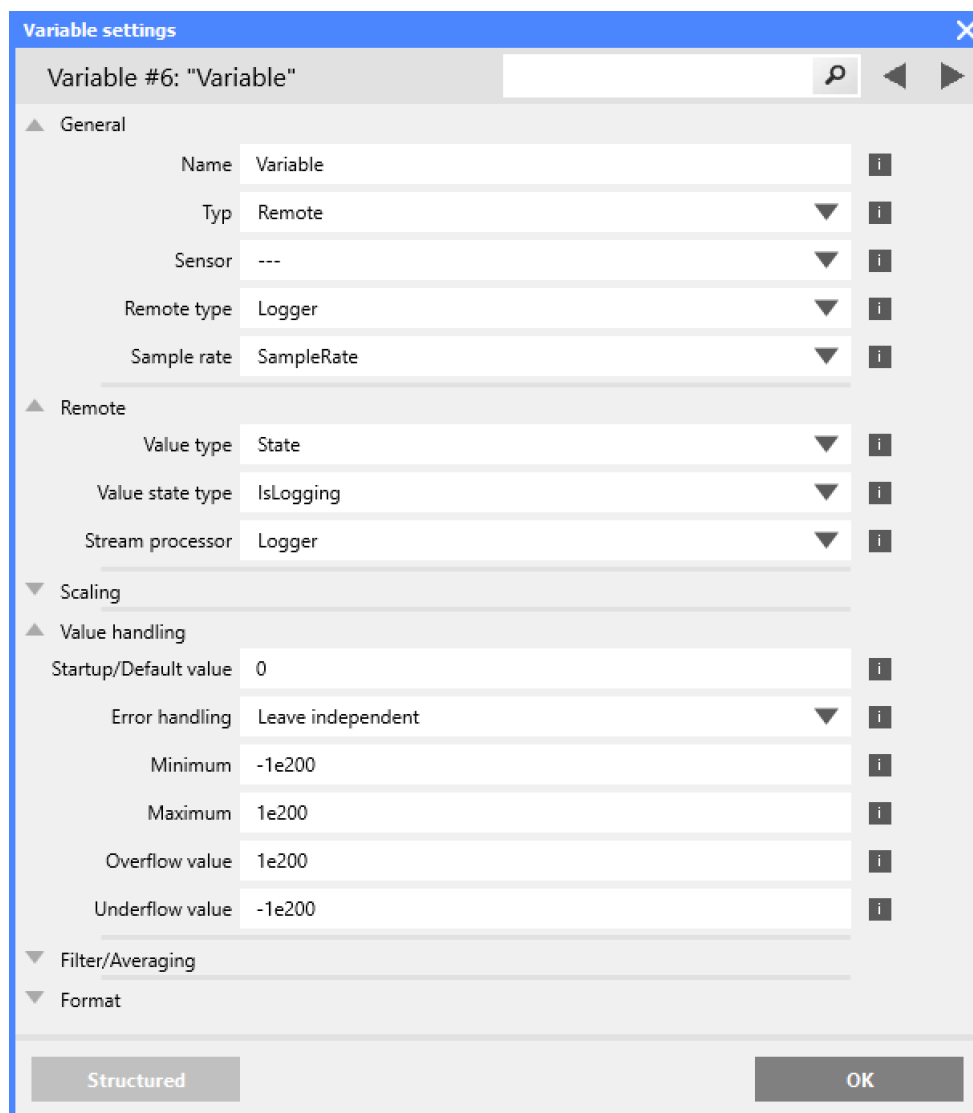

Fig. 7-16 Setting up IsLogging status virtual variable for a logger

There are numerous **Value state types** available to choose from. E.g., you can use the variable to determine whether the logger is active (enabled), whether the start or stop trigger has occurred, how many files have been saved, or how much storage space is still available on a target drive (refer to the following table).

Status	Explanation	Parameter
Enabled	Indicates whether a data logger is activated	1 = Data logger saved 0 = Data logger not saved
Logging	Indicates whether the data logger is currently saved	1 = Storage process is active 0 = Storage does not take place
Start trigger	Indicates whether a start trigger is active	1 = Start trigger is active 0 = Start trigger is not active
Stop trigger	Indicates whether a stop trigger is currently active	1 = Stop trigger is active 0 = Stop trigger is not active
Saved files	States how many files the data logger has saved since the function was activated. This is not the number of files which the data logger has created since switch-on or shipment.	-
File progress	Filling level of the current file (0 - 100%). 100% signifies that the file is complete (setting of File length).	-
Trigger progress	Logging length of the current logger file in percent (0 - 100%)	-
Mails sent	Number of mails sent since the function was activated	-
FTP sent	Number of files sent by FTP since the function was activated	-
Target	Index of the target memory (from the list of target memories) on which storage is currently taking place. The index of individual target memories is shown with the status information of the test controller. In the mode Automatic drive selection you can find out to which memory writing is currently taking place.	Example: SD0 = Index 0 USB0 = Index 1 USB1 = Index 2
Target size	Total capacity of the memory in bytes. This is a fixed size which only changes when you connect another memory. Refer also to the following parameters.	-
Target remaining	This indicates how many bytes are still free on the memory medium to which writing is taking place.	-
Target occupied	This indicates how much space is already taken up on the current target memory (0 - 100%).	-

Status	Explanation	Parameter
Data source overflow	Here, the value 0 should always be read. Otherwise (≥ 1) the data are lost. The value states the number of overflows of the ring buffer.	-
Data source current size	This indicates how many bytes were in the ring buffer the last time the data logger wrote to it. The indication should always stay the same. If it becomes larger, then an overflow of the buffer memory is imminent.	-
Data source capacity	Maximum capacity of the ring buffer in bytes. This is a fixed size.	-
Data source maximum size	This shows the size of the largest packet that has been fetched from the ring buffer by the data logger. The value remains valid as long as no buffer overflow occurs. The value is reset when the data logger is deactivated.	-
Post-processor ¹⁾ overflow	Here, the value 0 should always be read. Otherwise (≥ 1) the data are lost. The value states the number of overflows of the post-processor.	-
Post-processor ¹⁾ current size	This indicates how many bytes were in the post-processor the last time the data logger wrote to it. The indication should always stay the same.	-
Post-processor ¹⁾ capacity	Maximum capacity of the post-processor in bytes. This is a fixed size.	-
Post-processor ¹⁾ maximum size	This shows the size of the largest packet that has been fetched from the post-processor by the data logger. The value remains valid as long as no buffer overflow occurs. The value is reset when the data logger is deactivated.	-

- ¹⁾ Post-processor: When a data logger is not operating at the same speed as its data source, i.e. the ring buffer, or if data is being computed in the logger, the Q.series XL produces a post-processor. The logger fetches its data from it. The post-processor and the ring buffer are therefore are memories where one directly follows the other.

7.4.4 Configuring Modbus RTU Signals

In the context menu for *Virtual variables*, click **Append variable**. Double-click on virtual variables within the GI.bench project tree to open the *Variable settings* window. Under **General Variable settings**, select **Type > Remote** to reveal settings related to Modbus RTU signals.

Port

In Fig. 7-17 the USB-to-RS-485 converter ISK 103 is used to access the Modbus interface: **USB 1** (refer to Section 7.1.4, page 150).

Address

Address of the receiving or transmitting bus device.

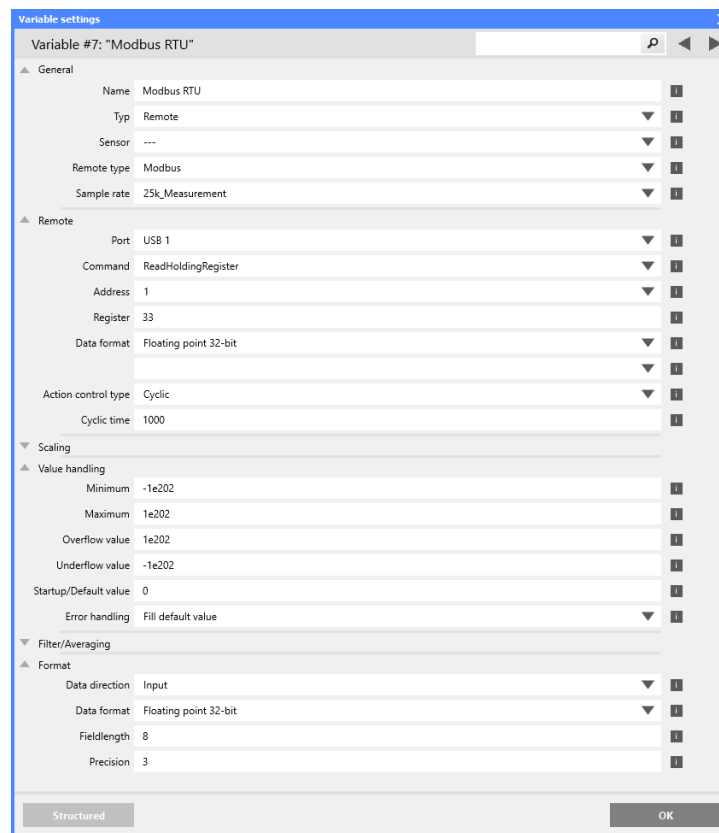

Fig. 7-17 Virtual variable settings for Modbus RTU signal

Register

Here, you specify the register address to be used (from the range defined above).

Action Control Type

Specify how values are to be read and written:

With **Fast**, values are processed at the **Div. System cycle freq.** (refer to page 141 for more details).

With **Cyclic**, values are processed only with a change of the value or on request (**via host**). If you select **Cyclic**, you then have to define the **Cyclic time** in ms.

Scaling	If needed, you can scale the values transferred via Modbus.
Error Handling	Here, you define the behavior or value to be displayed when the Modbus device no longer supplies the expected values.
Data Format (Q.series XL)	Specify the format of the value to be transferred via Modbus. The FLOAT formats require four bytes and therefore two registers. Define in which format the value is provided in the Q.series XL and whether the Modbus RTU variable is an Input , Output , or both (Data direction). For example, you can convert a FLOAT value on the Modbus into DOUBLE, i.e. a Floating point 64-bit value (double precision). Note that the formats must have at least two bytes in order to be able to transfer Modbus information.
Read/Write Permissions	In the context menu of the Q.station X Test Controller, select Edit data access rights and define whether variables are available for interfaces. Then activate the access (Read or Write) for the relevant interface.

7.5

Firmware update

Recently purchased modules or Test Controllers always contain the latest firmware, i.e. the included firmware in the modules or Test Controllers are current versions. However, if you want to combine new modules with older modules, you must update the firmware for all outdated devices.

It is essential to keep your software (e.g., *GI.bench*) updated to the latest version as well. Failure to do so can, in some cases, cause disturbances during operation via communication failures.

If required, download the latest versions of all Gantner software from our web site: www.gantner-instruments.com.

Before initiating a new *GI.bench* installation, uninstall all existing versions using *Windows Control Panel > Add/Remove Programs*. Once the previous version has been uninstalled successfully, you may then install the newest version of *GI.bench*.

7.5.1

Firmware Updates for Q.station X

Procedure

1. Contact a domestic Gantner Instruments Sales and Service location for assistance in acquiring an up-to-date version of Q.station X firmware. Included will be a special tool called *GInsFirmwareLoader*.
2. Install the firmware loader and download the latest firmware version (do not unzip the firmware).
3. Run the installed *GInsFirmwareLoader* program.
4. Scan the network using the tool *GInsFirmwareLoader* for all connected Test Controllers. If the Q.station X is found then it is displayed in the window. If no Test Controller is found, you may have to enter the address manually or set the IP address of your PC to the segment used by the Test Controller; refer also to Chapter 6, *Connect Q.station X to a PC*, page 119.
5. Select the Test Controller that is to receive updated firmware.
6. Select the downloaded firmware zip file, e.g., *MK175XXX#_Standard_##qstation-qa3-32_V212_B08.zip* and click on **OK**.
7. Allow the update process to complete without interruption, i.e., do not power down or unplug the system during update.
8. Click on **OK** and close the window of the update tool.

Wait until the Q.station X has finished a full restart. The firmware update is completed once the Q.station X restart has completed.

8

Configure the Modules

You must first establish a connection between the Q.station X Test Controller and a PC before you can configure connected modules. Use *GI.bench* for establishing a connection with the Q.station X; refer to Chapter 6, *Connect Q.station X to a PC*, page 119.

A *GI.bench* license code is needed to be able to use the program. During the installation of *GI.bench*, the user can request a license of *GI.bench* via email. If the request is valid, then a license code is sent back to the user via email reply that activates *GI.bench*.

The following describes the most important settings to obtain a system suitable for acquiring measurements.

i Tip

Use *GI.bench* for the initial setup of Q.series XL systems.

If you already have a *GI.bench* project configuration file (i.e., with file extension: **.gipbj**) with the required settings available, you can **Load** this config file into *GI.bench*, e.g., Fig. 8-1.

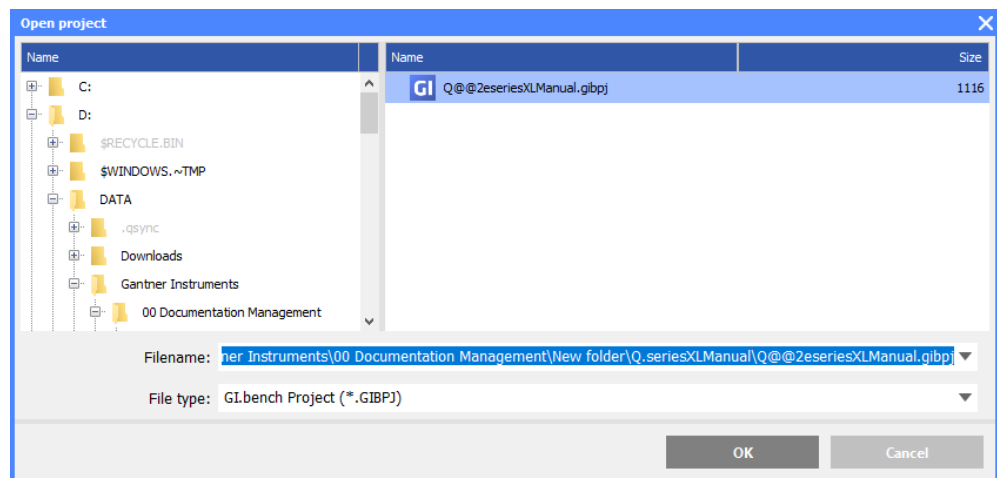

Fig. 8-1 Loading (opening) a previously saved *GI.bench* project

! IMPORTANT

Before combining and reusing modules and Test Controllers from previous applications, especially with recently purchased ones, ensure that all devices are updated with the latest internal software, i.e., *Firmware*. To do this, perform firmware updates; refer to Section 7.5.1, page 164 and to learn the Q.station X firmware update procedure.

Basic Procedure

- Establish a connection (communication) between the PC and module(s) via a Q.station X or other Q.station in *GI.bench*;
- Define the modules, sensors, and the scaling used to obtain quality measurements of a physical quantities.
- Define arithmetic computations, digital inputs/outputs, alarm monitoring, etc.
- Write all configurations to the modules and Test Controller.

i Tip

At many points in the programs you can call the setting dialogs or settings via the context menu of an entry. You call the context menu with the right mouse key.

8.1

8.1.1

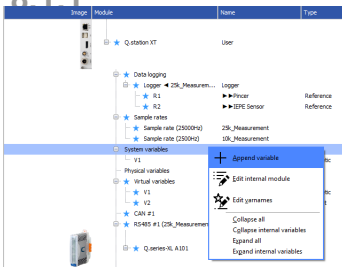

Configuring Analog Inputs

Sensor Parameters in *GI.bench*

In order to adjust channel configurations for analog variables, the modules should be physically connected to the Q.station X Test Controller and the configuration program, *GI.bench*, should be installed and licensed, i.e., ready for measurement. For more information on the installation of *GI.bench*, refer to Section 6.6, *Installing GI.bench*, page 131 for detailed instructions.

Existing modules can be brought into the *GI.bench* project via **Read**. Right-click on a module and select **Append Variable** from the context menu to add a new variable to the module. Note that double-clicking on a module will bring up the *Module settings* window instead. From the *Module settings* window, the module **Location**, **Address**, and **Data-transfer** status are configured. The **Baudrate** of the module must be configured via the RS-485 adapter that the module is appended to.

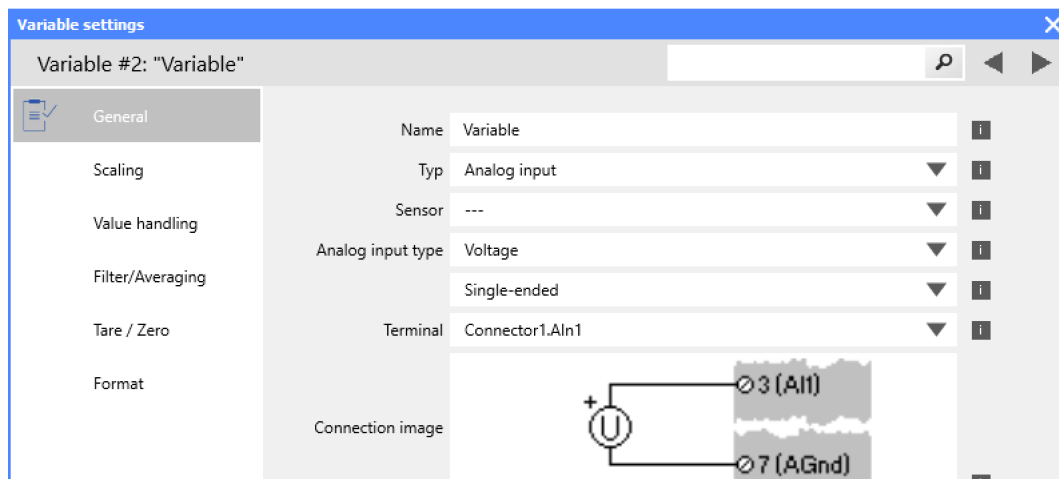

Fig. 8-2 Variable settings for single-ended voltage input via A101

Alternatively, you may fully configure an off-line project without connected hardware and then, once hardware is connected, load the aforementioned project into the Q.station X Test Controller.

All module signals are defined as *variables*. Double-click on any variable or right-click on any variable and select **Edit variable** to open the *Variable settings* window for configuration.

Procedure

1. Double-click on any variable or right-click on any variable and select **Edit variable** to open the *Variable settings* window for configuration.
2. Define the **Name** of the variable, e.g., Voltage Input 1.
3. Define the **Sample rate** of the Analog input variable.
4. Select the variable **Type** as **Analog input**.
5. Define the **Sensor** type to be used.
Depending on the type of module, you have various options available, e.g. **Bridge** for strain gage full and half-bridges, **Pt100/500/1000** or **Resistance** for resistors, and **Voltage** for voltage measurements. Selecting a **Sensor** may update **Analog input type**, **Scaling**, or **Value handling** accordingly.
6. Define the **Analog input type** and specify a type of circuit or additional variation of the selected sensor type if available.
Depending on the selected sensor type, you have various options available, e.g. **2-wire** or **4-wire** (circuit) for resistive transducers and **Resistive Full 3-, 4-, 5-, 6-wire** (circuit) for strain gage full bridges.
The **Connection image** shows you the pin assignment to be used. With more than one input, inputs are to be connected from first to last (i.e., Input 1 on Plug 1, to Input *n* on Plug 2, etc.). Check that all sensors are connected correctly.
7. Click on **Scaling** to define the scaling settings for the sensor.
Depending on the type of sensor selected, you have various options available (refer also to Section 11.3, *Sensor Scaling in GI.bench*, page 215):
 - For voltage signals, specify a conversion of the measured voltage to a desired physical quantity. By default, sensor inputs are measured without conversion (scaling).
 - For thermocouples or Pt100 sensors, no additional scaling is required as the conversion into °C occurs automatically. The scaling is only needed when you want to convert to °F or K. In this case, define the **Unit** and **Scaling method**. Default method is **Factor and offset**. For a display in °F enter the factor **1.8** and **32** as the offset. For a display in °K enter the factor **1** and **-273.15** as the offset.
 - For full and half-bridge transducers, obtain the necessary information from a data sheet or a transducer calibration certificate. E.g., for a force transducer (2.03mV/V at 5kN), enter the **Unit (kN)** and then click on **Scaling method**.

Use the method **2-point calibration**. Enter in each case **0** for **Point 1** for **Interm.**(ediate) [**mV/V**] and **Eng.**(ineering) [**kN**]. Then enter **2.03** as **Interm.**(ediate) [**mV/V**] and **5** as **Eng.**(ineering) [**kN**] for **Point 2**.

Alternatively, you can also define **N** for **Unit** and then **5000** as **Eng.**(ineering) [**kN**] for **Point 2**.

- For strain gages, an additional tool called **Strain gage calculator** is available. Here, the unit is automatically changed to **µm/m**. In the *Variable settings* window, enter the **k factor** of your strain gage and the **Bridge factor (B)** for the circuit.
8. Floating point numbers are always transferred as 4-byte values, therefore, no further changes to **Format** will be needed. For the formats **Signed integer 16-bit** (2 bytes) and **Signed integer 32-bit** (4 bytes), ensure to specify the **Precision** and the total number of places to be output (**Fieldlength**). The **Fieldlength** is calculated including the initial decimal point and is displayed without commas in thousandths positions, e.g., specifying three decimal places displays the value 1234 (i.e., as opposed to 1,234).
After defining the settings above, the number of transferred decimal places are displayed in the *Format* column within the project **Configuration** tree, e.g. **#####.##**.
If negative numbers occur, the displayed value in this example is limited to -9999.99 (seven characters without the comma).
 9. In the **Value handling** options, you may adjust the **Range** and **Error handling** to manually limit the admissible value range and to define the reaction in the case of an error (optional).
 10. Specify filtering of the sensor signal in the options **Filter/Averaging**.
 11. Save configurations by clicking **OK** once you have made all the necessary changes to *Variable settings*.
Once all changes to the project are complete, click **Write** to upload the configuration file to the Q.station X.
A file is created within the project folder and bears the same name as the project.

IMPORTANT

In *GI.bench*, a  is displayed next to any items within the project configuration tree that have received changes. To commit updated settings on the Q.station X Test Controller, in *GI.bench* select **Read** from the toolbar. Project files are saved to your PC automatically when written to the Q.station X Test Controller.

8.1.2

Carrier Frequency Synchronization (Q.series XL A106)

The A106 module supports the supply of sensors with direct voltage (**DC**) or carrier frequency (**CF 600 Hz** and **CF 4800 Hz**).

- ➔ If you are using several modules of this type and set define a carrier frequency supply (**CF 600 Hz** or **CF 4800 Hz**), synchronize the carrier frequencies of the modules otherwise crosstalk can occur between the supply line and signal inputs of the modules.

After selecting a carrier frequency, you have three methods of supply:

1. **No sync.**(hronization)

This setting is practicable when you are only using one module with carrier frequency supply. Within a module all carrier frequency generators are automatically synchronized.

2. **Internal sync.**(hronization)

Set this type of synchronization for *one* module. The module then becomes the master to which all other modules synchronize.

3. **External sync.**(hronization)

Specify this type of synchronization for all other modules so that they synchronize to the master.

For synchronization, the Sync port interface on the Q.station X is utilized (Fig. 4-5, page 25).

i **Tip**

We recommend that only one variant of the carrier frequency is used, i.e. do not mix 600 Hz and 4800 Hz with multiple modules.

Do not forget to Write new settings to the Q.station X (refer to Section 8.1.1, *Sensor Parameters in GI.bench*, page 166).

8.1.3

Zeroing and Taring Sensor Measurements

You have two ways of adjusting a measurement offset to zero, e.g., for applications involving pre-loaded sensors:

- **Zero**

With this method, measurement takes place over a certain time period and the mean is computed. This mean value is then subtracted from all the following measurements.

- **Tare**

With this method, a (single) measurement present at a certain point in time is subtracted from all following measurements.

Zeroing and taring are performed manually as needed during test setup or triggered either via variables or via the host (GI.bench). The duration for zeroing and taring via GI.bench (via host) is set to 1 second.

Manual Activation (via host)

In the *Variable settings* window of the variable to be zeroed or tared, access the **Format** tab and define the **Data direction** as **Input/Output** (Fig. 8-3, page 171).

In the **Tare/Zero** tab of the *Variable settings* window, check the box for **Zero on host** or **Tare on host** (Fig. 8-3, page 171).

In *GI.bench*, click the **Data acquisition** tab to bring up the *Channels (F3)* dialog. You should now see the **Zero** or **Tare** button in the *Action* column (Fig. 8-4, page 171). Clicking the **Zero** or **Tare** button on this screen activates the operation for that channel.

Automatic/Manual Activation (via variable)

In the **Tare/Zero** tab of *Variable settings* window, check the box for **Zero on variable** or **Tare on variable** (Fig. 8-3, page 171).

An additional field will appear under the **Zero on variable** or **Tare on variable** options to select a reference variable that is checked to activate the desired operation (Fig. 8-3, page 171).

Define the **Data direction** of the referenced variable as **Input/Output** in the **Format** tab of *Variable settings*. This will activate a **set value** button in the *Write* column of the *Channels (F3)* dialog under the **View** tab in *GI.bench*. This **set value** button will allow you to change the value of this referenced variable to the appropriate code(s) for the desired operation(s) to activate. The appropriate code(s) can be referenced in Fig. 8-5, page 172.

Procedure (via variable)

1. Create a new reference variable and specify a **Name** for the variable, e.g., the purpose of the signal such as `Zero_tare`.
2. Within the *Variable settings* of the influenced variable, go to the **Tare/Zero** tab and select the desired condition(s), i.e., **Tare on variable** or **Zero on variable** (e.g., Fig. 8-3, page 171).
3. Select the referenced variable (e.g., `Zero_tare`) to be checked to activate the desired operation (e.g., Fig. 8-3, page 171).
4. Close the *Variable settings* window by clicking **OK**.
5. Change the value of this referenced variable to the appropriate code(s) to trigger the desired operation(s). The appropriate code(s) can be referenced in Fig. 8-5, page 172.



Fig. 8-3 Define the desired conditions for Zero and/or Tare

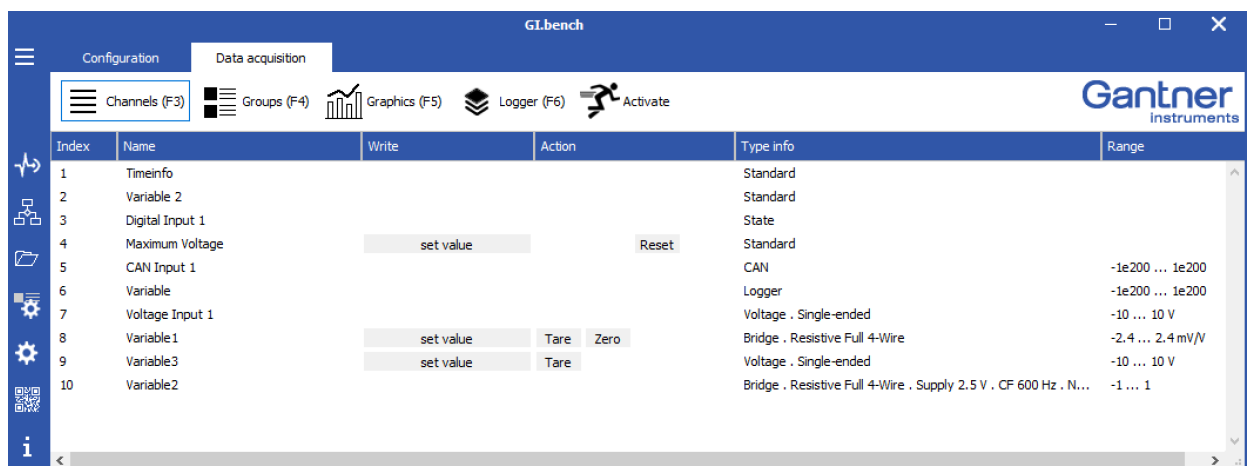

Fig. 8-4 Zero, Tare, and set value buttons in Data acquisition tab

When defining the variable condition (e.g., *Zero_tare*) manually, use the following codes to trigger an operation action, e.g., taring or zeroing activation, or reset existing zero or tare operations:

Code	Function
1	Perform taring
2	Reset tare (delete stored tare value)
4	Perform zeroing. The mean of the measurement value is calculated until the value 0 is written to the variable.
8	Reset zero balance (delete stored zero value)
16	Activate Shunt Resistor or Reset charge input

Fig. 8-5 Codes for activating Zero/Tare/Shunt Resistor

8.2

Defining Digital Inputs and Outputs

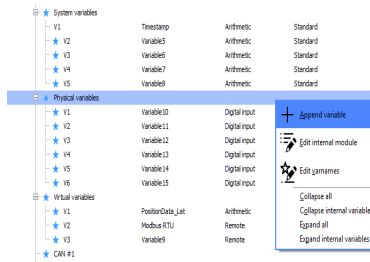

In order to adjust channel configurations for digital variables, the modules should be physically connected to the Q.station X Test Controller and the configuration program, *GI.bench*, should be installed and licensed, i.e., ready for measurement. For more information on the installation of *GI.bench*, refer to Section 6.6, *Installing GI.bench*, page 131 for detailed instructions.

Existing modules can be brought into the *GI.bench* project via **Read**. Right-click on a module and select **Append Variable** from the context menu to add a new variable to the module. Note that double-clicking on a module will bring up the *Module settings* window instead. From the *Module settings* window, the module **Location, Address, and Data-transfer** status are configured. The **Baudrate** of the module must be configured via the *RS-485* adapter that the module is appended to.

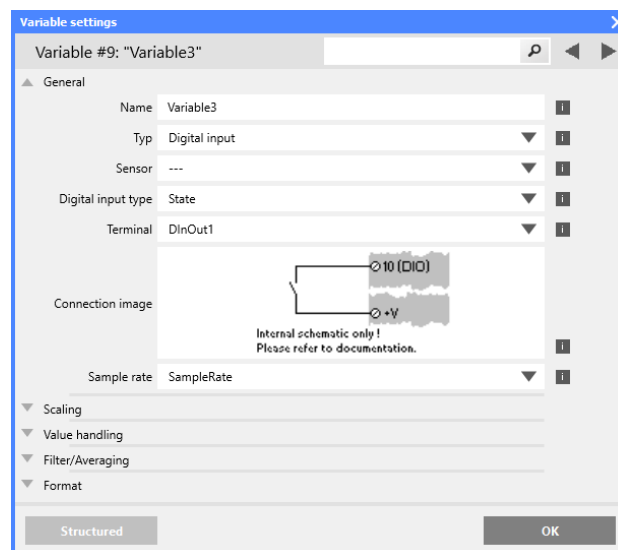

Fig. 8-6 Configuring a digital input via Variable settings

Procedure

1. Double-click on any variable or right-click on any variable and select **Edit variable** to open the *Variable settings* window for configuration.
2. Define the **Name** of the variable, e.g., Digital Output 1.
3. Define **Sample rate** for the digital input or output variable.
4. Select the variable **Type** as **Digital input** or **Digital output**.
The **Connection image** shows you the pin assignment to be used. With more than one input, inputs are to be connected from first to last (i.e., Input 1 on Plug 1, to Input *n* on Plug 2, etc.). Check that all sensors are connected correctly.
5. For **Digital output**, click on **Digital input type** and specify whether you want to use the output as **State**, **Output set**, **Process output**, or **PWM/Frequency**.
Process output: The output monitors a module signal and changes the output level under certain conditions. Click on **Threshold (OR combined)** and specify alarm conditions.
 - You can specify up to four alarm conditions. When one of the conditions is satisfied, the alarm signal is triggered.
 - Select the desired alarm monitoring switching behavior and the levels at which switching is to occur.
 - Enter the variable based switching level (for **Value type: Is variable**) or the constant based switching level (for **Value type: Is constant**).
6. Click on **Format** to configure the data transfer.
Since digital signals do not require any decimal places, you can enter **0** for **Precision**. An entry of **1** is sufficient for the **Fieldlength**. With a digital input you can also specify a Unit within the **Scaling** options (optional).
7. Save configurations by clicking **OK** once you have made all the necessary changes to *Variable settings*.
Once all changes to the project are complete, click **Write** to upload the configuration file to the Q.station X.
A file is created within the project folder and bears the same name as the project.

! IMPORTANT

In *GI.bench*, a ★ is displayed next to any items within the project configuration tree that have received changes. To commit updated settings on the Q.station X Test Controller, in *GI.bench* select **Read** from the toolbar. Project files are saved to your PC automatically when written to the Q.station X Test Controller.

8.3

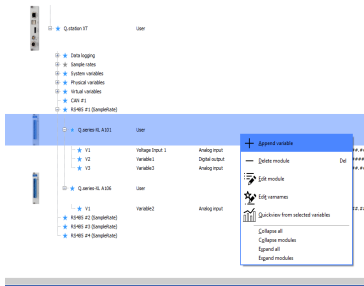

Configuring Analog Outputs

In order to adjust channel configurations for analog variables, the modules should be physically connected to the Q.station X Test Controller and the configuration program, *GI.bench*, should be installed and licensed, i.e., ready for measurement. For more information on the installation of *GI.bench*, refer to Section 6.6, *Installing GI.bench*, page 131 for detailed instructions.

Existing modules can be brought into the *GI.bench* project via **Read**. Right-click on a module and select **Append Variable** from the context menu to add a new variable to the module. Note that double-clicking on a module will bring up the *Module settings* window instead. From the *Module settings* window, the module **Location**, **Address**, and **Data-transfer** status are configured. The **Baudrate** of the module must be configured via the *RS-485* adapter that the module is appended to.

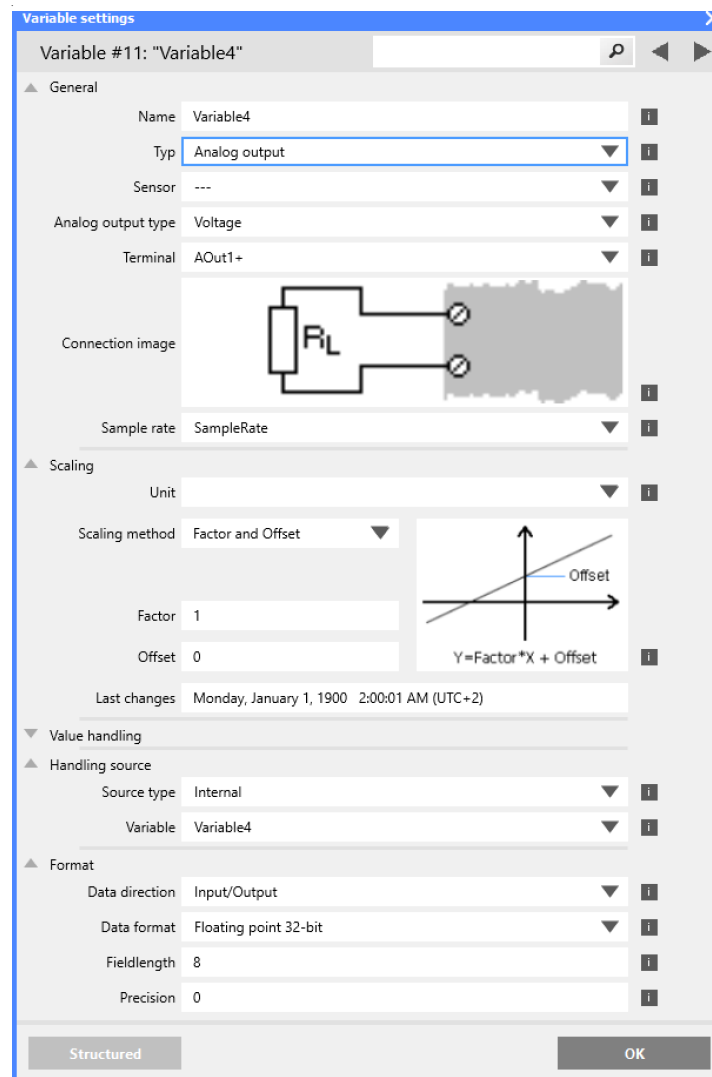



Fig. 8-7 Variable settings for the configuration of analog outputs

Procedure

1. Double-click on any variable or right-click on any variable and select **Edit variable** to open the *Variable settings* window for configuration.
2. Define the **Name** of the variable, e.g. Analog Output 1.
3. Define the **Sample rate** for the analog output variable.
4. Select the variable **Type** as **Analog output**.
The **Connection image** shows you the pin assignment to be used. With more than one input, inputs are to be connected from first to last (i.e., Input 1 on Plug 1, to Input *n* on Plug 2, etc.). Check that all sensors are connected correctly.
5. Click on **Analog output type** and specify whether you want to use the output as **Voltage** or **Current**.
6. Select the desired **Terminal** for the analog output variable.
7. In the **Format** options, the output format is shown however changes are not necessary.
8. Click on **Value handling** to define the range (**Minimum** and **Maximum**), **Overflow** and **Underflow values**, and **Error handling**.
9. Click on **Handling Source** to specify the signal source (**Source type** and **Variable**) used for the output.
10. Save configurations by clicking **OK** once you have made all the necessary changes to *Variable settings*.
Once all changes to the project are complete, click **Write** to upload the configuration file to the Q.station X.
A file is created within the project folder and bears the same name as the project.

! IMPORTANT

In *GI.bench*, a  is displayed next to any items within the project configuration tree that have received changes. To commit updated settings on the Q.station X Test Controller, in *GI.bench* select **Read** from the toolbar. Project files are saved to your PC automatically when written to the Q.station X Test Controller.

8.4

Defining Computations (Virtual Variables)

In order to adjust channel configurations for virtual variables, the modules should be physically connected to the Q.station X Test Controller and the configuration program, *GI.bench*, should be installed and licensed, i.e., ready for measurement. For more information on the installation of *GI.bench*, refer to Section 6.6, *Installing GI.bench*, page 131 for detailed instructions.

Existing modules can be brought into the *GI.bench* project via **Read**. Right-click on a module and select **Append Variable** from the context menu to add a new variable to the module.

Note that double-clicking on a module will bring up the *Module settings* window instead. From the *Module settings* window, the module **Location**, **Address**, and **Data-transfer** status are configured. The **Baudrate** of the module must be configured via the **RS-485** adapter that the module is appended to.

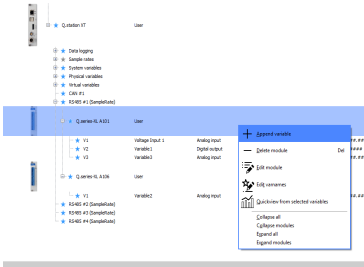



Fig. 8-8 Dialog with configuration for a computation

Procedure

1. Double-click on any variable or right-click on any variable and select **Edit variable** to open the *Variable settings* window for configuration.
2. Define the **Name** of the variable, e.g. Maximum Voltage.
3. Select the variable **Type** as **Arithmetic**.
4. Select the desired **Sample rate** for the virtual variable.
5. Click on **Functions** and specify the required computation.
In the upper dialog field you can enter, as on a pocket calculator, a formula which can use existing module variables. Create functions via the **Set at cursor** buttons and commit changes to a formula via **Set formula**. Click on **OK** once you have defined the required computation.
6. Click in the column **Handling Source** to specify the signal source (**Source type** and **Variable**) used for the output.
7. Floating point numbers are always transferred as 4-byte values, therefore, no further changes to **Format** will be needed. For the formats **Signed integer 16-bit** (2 bytes) and **Signed integer 32-bit** (4 bytes), ensure to specify the **Precision** and the total number of places to be output (**Fieldlength**). The **Fieldlength** is calculated including the initial decimal point and is displayed without commas in thousandths positions, e.g., specifying three decimal places displays the value 1234 (i.e., as opposed to 1,234).
After defining the settings above, the number of transferred decimal places are displayed in the *Format* column within the project **Configuration** tree, e.g. #####.##.
If negative numbers occur, the displayed value in this example is limited to -9999.99 (seven characters without the comma).
8. Save configurations by clicking **OK** once you have made all the necessary changes to *Variable settings*.
Once all changes to the project are complete, click **Write** to upload the configuration file to the Q.station X.
A file is created within the project folder and bears the same name as the project.

! IMPORTANT

In *GI.bench*, a  is displayed next to any items within the project configuration tree that have received changes. To commit updated settings on the Q.station X Test Controller, in *GI.bench* select **Read** from the toolbar. Project files are saved to your PC automatically when written to the Q.station X Test Controller.

8.5

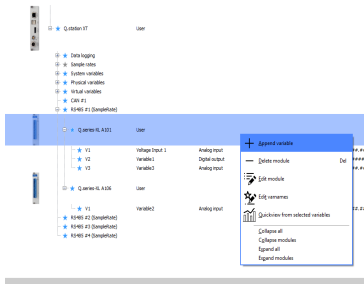

Configuring Alarm Monitoring

In order to adjust channel configurations for alarm monitoring, modules should be physically connected to the Q.station X Test Controller and the configuration program, *GI.bench*, should be installed and licensed, i.e., ready for measurement. For more information on the installation of *GI.bench*, refer to Section 6.6, *Installing GI.bench*, page 131 for detailed instructions.

Existing modules can be brought into the *GI.bench* project via **Read**. Right-click on a module and select **Append Variable** from the context menu to add a new variable to the module. Note that double-clicking on a module will bring up the *Module settings* window instead. From the *Module settings* window, the module **Location**, **Address**, and **Data-transfer** status are configured. The **Baudrate** of the module must be configured via the *RS-485* adapter that the module is appended to.

➔ In order to monitor a limit and to output a level on a digital output when an alarm occurs, you can directly use the function of the digital output. You do not need to set up alarm monitoring via a separate variable. Alarm monitoring is used to monitor signals for modules and to make the result available to the PC or PLC as a preconditioned signal.

Procedure

1. Double-click on any variable or right-click on any variable and select **Edit variable** to open the *Variable settings* window for configuration.
2. Define the **Name** of the variable, e.g. Input 1 High Level.
3. Select the variable **Type** as **Alarm**.
4. Select the desired **Sample rate** for the virtual variable.
Click on **Threshold (OR combined)** and specify conditions.
 - You can specify up to four alarm conditions. When one of the conditions is satisfied, the alarm signal is triggered.
 - Select the desired alarm monitoring switching behavior and the levels at which switching is to occur.
 - Enter the variable based switching level (for **Value type: Is variable**) or the constant based switching level (for **Value type: Is constant**).
5. Click in the column **Handling Source** to specify the signal source (**Source type** and **Variable**) used for the output.
6. Click in the column **Format/balance** to specify the transfer format.

Since the alarm signal, like digital signals, does not require any **Decimal** places, you can enter **0** here. **1** is sufficient for the **Field length**.

When the dialog is closed, the number of transferred places and the unit in the column **Format/balance**, e.g. **f**, are displayed.

7. Save configurations by clicking **OK** once you have made all the necessary changes to *Variable settings*.
Once all changes to the project are complete, click **Write** to upload the configuration file to the Q.station X.
A file is created within the project folder and bears the same name as the project.

 **IMPORTANT**

In *GI.bench*, a  is displayed next to any items within the project configuration tree that have received changes. To commit updated settings on the Q.station X Test Controller, in *GI.bench* select **Read** from the toolbar. Project files are saved to your PC automatically when written to the Q.station X Test Controller.

9

Record Data with Loggers

For the capture and storage of data, a Q.station X Test Controller can be configured to have up to 20 active internal data loggers at a time. Q.station X data loggers continuously measure configured input signals and can calculate derived values using arithmetic functions, if required. Each data logger on the Q.station X can be assigned a logging rate within the range of 100kHz to 24h and each input signal can be assigned to multiple data loggers at their individually specified logging rates. Asynchronous signals from serial (USB) sensors and devices will only be detected by the Q.station X at the point of receiving said signals.

The setup of a data logger can be quick and simple, but in any case, you must perform the following steps in order to log data:

1. First, you must define the data buffers of the Q.station X.
2. Second, you must set the desired sampling rate per variable by assigning each variable to the appropriate data buffer.
3. Next, you must create the necessary system data stream per data buffer to be assigned to the logger(s) for data storage.
4. Lastly, you must define the settings for each data logger.

➔ You can record data at any rate equal to or lesser than the **Div. Cycle Freq.** (i.e., sampling rate) configured in the first step (e.g., see *Logging Rate Divider* in Section 9.4.4, page 197).

The aforementioned steps required to be able to log data are all available within the *GI.bench* project configuration tree via the following *context menu* options (i.e., right-click item in brackets):

- **Add sample rate** [*Controller*] for configuring sample rates (i.e., adding data buffers; double-click to edit *Sample rates*).
- **Edit variable > Sample rate** [*Any variable*] to assign the desired pre-configured data buffer(s) to all variable(s).
- **Add system datastream** [*System streams*] to create a stream processor. A datastream can be either be internally sourced (e.g., data buffer #1) or externally sourced (e.g., data from external devices). Define settings and select the variables for each data stream. Data streams are necessary for settings elsewhere in *GI.bench*, e.g., Data logger settings.
- **Add logger** [*Controller*] for the creation and configuration of data loggers; note that loggers require existing data streams:
 - **Available variables** in *Data logger settings* depend on the variables previously assigned to the *System stream(s)* defined in the **Data source** field within the same settings.
 - **Available variables** in *Stream processor settings* depend on the variables previously assigned to the *Sample rate(s)* defined in the **Stream** field within the *Datastream* options of the *Stream processor settings* window.

9.1

Configure Sampling Rates and Data Buffers

You must define the data buffer(s) and the respective sampling rate(s) of the Test Controller before logging is possible.

To do this, right-click on the Q.station X within a *GI.bench* project tree to access the context menu and select **Add sample rate** in the context menu (see Fig. 9-1). Alternatively, right-click on the category *Sample rates* within a *GI.bench* project tree and select **Add sample rate** in that context menu.

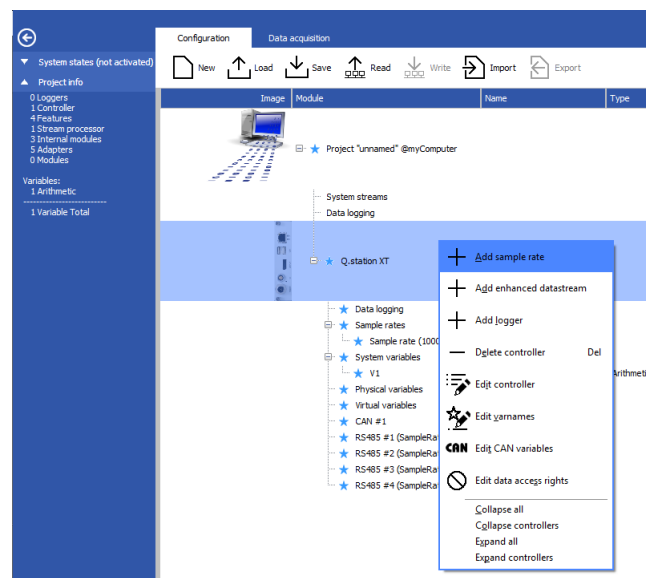

Fig. 9-1 Adding a new sample rate to the Q.station X in GI.bench

In either case, a new sample rate entry will appear under the *GI.bench* project tree category, *Sample rates*. Double-click on the first (or new) sample rate, e.g., **Sample rate (100000Hz)** to see the *Sample rate settings* window (e.g., see Fig. 9-2).

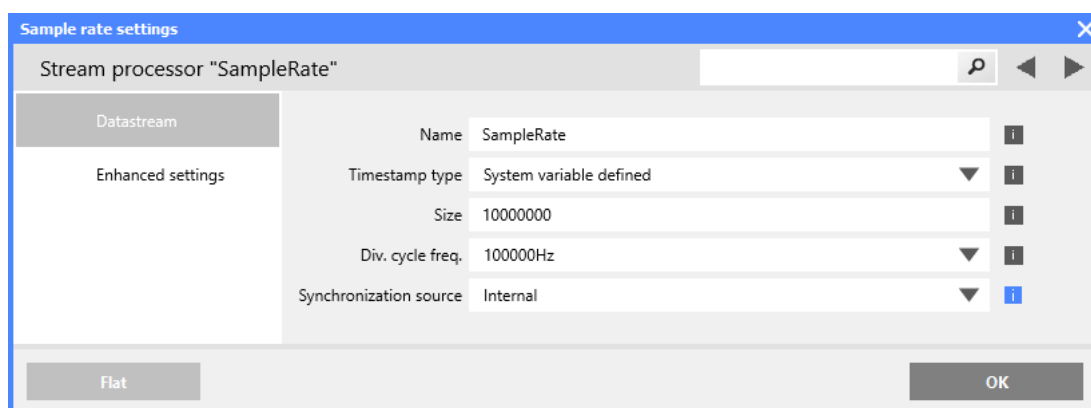

Fig. 9-2 Sample rate settings in GI.bench for Sample rate #1

Within the *Sample rate settings* window, you must define *Sample rates #1* through *#4* as needed (i.e., data buffers #1 through #4 that will record the measured values). The necessary definitions include the following:

- the **Name** of the data buffer (e.g., *10k_Measurement*),
- the **Timestamp type** to be used for values on the data buffer,
- the **Size** of the data buffer in MB (maximum 200MB),
- the **Div.(ided) Cycle Freq.**(uency), i.e., sampling frequency of *Sample rates #2* to *Sample rate #4*
 - *Sample rate #1* is set via Q.station X context menu: **Edit controller > Synchronization > Div. base cycle freq.**,
- the **Synchronization source** as either Q.station X internal clock or an external source (for *Sample rates #2* to *#4* only).

Once a data buffer is fully defined, it can then be assigned to the variables throughout the project freely within *Variable settings* (via any variable context menu).

i **Tip**

Only use *one sample rate per UART*, especially for analog signals. *Two* sample rates operating within *one* UART (e.g., *RS-485 #1*) may otherwise lead to inaccuracies in measurements. Modules on the same UART should be assigned to the same data buffer. If in doubt, use the highest sample rate of all modules on a UART as the **Div. Cycle Freq.** of the data buffer they are assigned to.

Sample Rate #1

Sample rate #1 (Data buffer #1; default name: *SampleRate*) is unlike all other data buffers: The first data buffer serves as the *base sample rate of the system*. All other sample rates must be equal to or less than the sample rate of the primary data buffer (i.e., 1st UART must be as fast or faster than subsequent UARTs).

Sample rate #1 also provides the synchronization basis for all other sample rates, i.e., sample rates are either synchronized to the same as or scaled to be lower than *Sample rate #1* such that all measurements are taken at time points when measurements take place for *Sample rate #1* as well.

- ➔ The above does not apply to the **Synchronization source > External** operating mode.

Sample rate #1 will always be limited to the **Synchronization source > Internal** operating mode as it is the base sampling rate of the system.

Therefore, in order to adjust the sampling rate of Data buffer #1, access the *Controller settings* via the Q.station X context menu: **Edit controller > Synchronization > Div. base cycle freq.** (e.g., refer to Fig. 9-3, page 184).

! IMPORTANT

When changing *Sample rate #1* via **Div. base cycle freq.** (e.g., see Fig. 9-3), the **Div. System cycle freq.** changes proportionally to *Sample rate #1*. For example, with a base cycle frequency of 10,000Hz and a system cycle frequency of 1000Hz, reducing the base cycle frequency from 10,000Hz to 1000Hz will reduce the system cycle frequency from 1000Hz to 100Hz, as well.

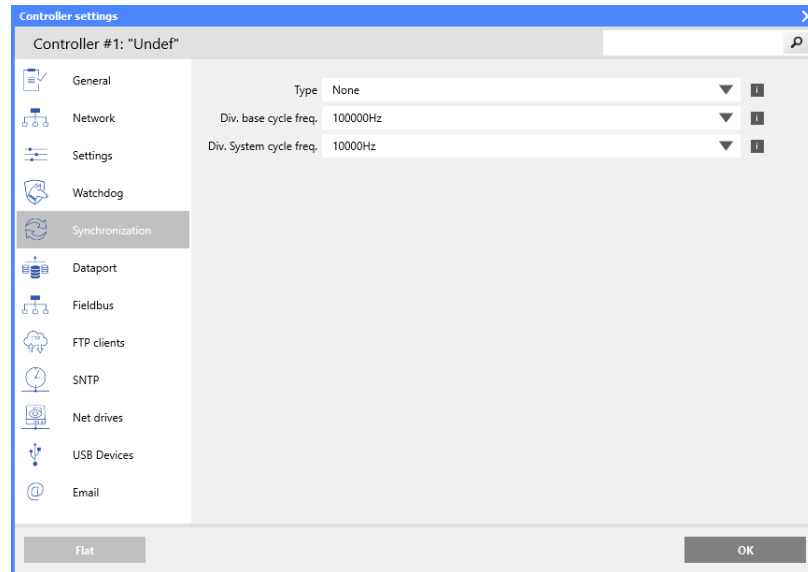

Fig. 9-3 Configure the sampling rate of Data buffer #1 via the Synchronization Controller settings in GI.bench

9.1.1

Sample Rate Settings

Name

You can leave the default name or create a useful identifier, e.g., an indicator for the sample rate used, e.g., *10k_Measurement*.

Timestamp Type

Sample rate #1 can only be assigned the **Timestamp type > System variable defined** (i.e., defined by the *System variable, V1*; default name: **Timeinfo**).

! IMPORTANT

System time (*System variable, V1: Timeinfo*) must be assigned to *Sample rate #1* (Data buffer #1). This must not be changed.

Sample rate #2 to *Sample rate #4* can be assigned one of three options for **Timestamp type**: **Time in EtherCAT DC format** (distributed clock), **Actual sample rate cycle counter**, and **Off** to simply use the standard timestamps.

Specifying **Actual sample rate cycle counter** is effective, e.g., with **Synchronization Source > External**, in particular with a reset signal; refer to *Size (Data Buffer)*, below, e.g., with the above, you can configure a channel that can measure the angle of rotation and reset to zero after each full revolution.

Size (Data Buffer)

The data buffer functions as a circular buffer, i.e., oldest values are overwritten after the data buffer is filled once wholly. The data buffer can be read from several places at the same time; up to 10 connections are via Ethernet possible for example.

In total, you have a maximum of 20 MB of buffer size available.

- ➔ The size must always be specified in bytes, so check the number of zeros in each entry, e.g., max. entry 20MB: **209715200** bytes. Entries in seconds or similar units are not acceptable for **Size**.

Div. Cycle Frequency

Sample frequency is the frequency at which measured values are read into the test controller. Note, the settings for a data buffer are independent of a logger's storage rate (**Logging rate**).

No sample rate may be higher than *Sample rate #1*.

- ➔ The updating of virtual and system variables is not determined by the sample rate, but rather by the cycle frequency of the system; refer to **Div. System Cycle Freq.** in Section 7.1.1.1, page 139.

Synchronization Source

Sample rate #1 is always limited to the **Synchronization source > Internal** operating mode, because this sample rate is the base cycle frequency of the system. In default settings, *Sample rates #2* through *#4* are internally synchronized to *Sample rate #1*.

With *Sample rates #2* to *#4* you can synchronize to an external signal (**Synchronization source > External**), i.e. to obtain a measurement with angular synchronization.

In this case you have further entry fields available:

- **Timestamp Reset Type**

Here you can reset the cycle counter in particular for angular synchronous measurement. Q.station X supports 4 different methods and additional entry fields are provided depending on the method chosen (e.g., see Fig. 9-4, page 186):

- Reset on **Reference pulse**, i.e. when a (single) pulse occurs on the **Reset dig. input terminal**, the counter is reset and counting starts at 1 again with the next pulse.
- Reset on **Reference gap**, i.e. continuous signal pulses must occur on the **Reset dig. input terminal** simultaneously with the counter synchronization pulses. If a reset signal pulse is detected as missing on the reset dig. input, the counter is reset.

- Reset on **Reference signal falling edge**, i.e. when the signal level on the **Reset dig. input terminal** goes “low”, the counter is reset.
- Reset on **Reference signal rising edge**, i.e. when the signal level on **Reset dig. input terminal** goes “high”, the counter is reset.

Whether, when and which method you should use, depends on the angle sensor chosen. Usually a pulse on reaching the *zero* or *starting positions* is output, i.e. depending on the length of the pulse, you can use the first or one of the two last methods.

- **Dig.(ital) Input Terminal**

Specify on which digital input the synchronization signal is applied. **DIn1** may be used for time synchronization as well.

- **Dig.(ital) Input Slope Type**

Specify whether the rising or falling edge is to be referenced.

- **Debounce Count**

If the signal is produced by a mechanical contact, you can suppress the effect of “contact bounce” with this setting, i.e., “de-bouncing”. The signal level is then only valid when the number of samples (measurements) defined here exhibit the appropriate signal level (slope type dependent).

- **Min.(imum) Time Between Pulses**

With this setting you can also suppress contact bounce or the brief disturbances after an edge is detected: The next edge is only monitored when the time specified here has expired.

Make sure that the time defined here is *shorter than* the time between consecutive pulses at the highest rotational speed.

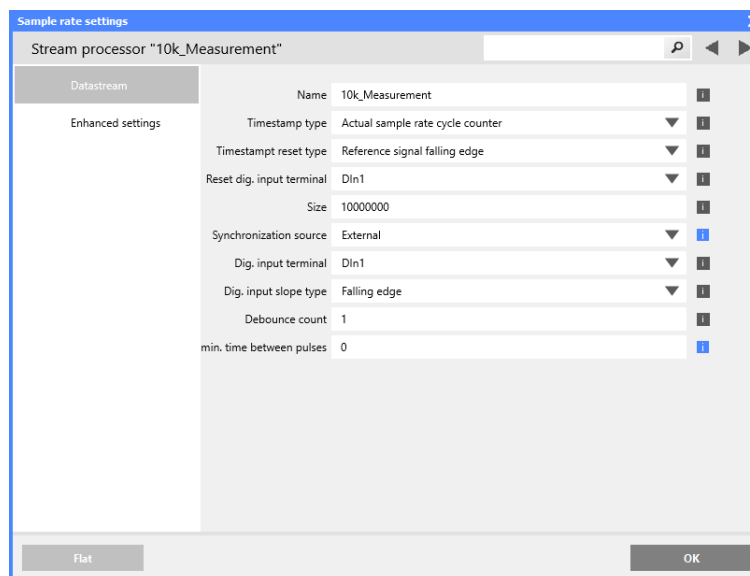

Fig. 9-4 Configuring Data buffer #2 for external synchronization via DIn1 on the Q.station X within settings in GI.bench

9.2

Assign Sample Rates to Variables

In the **Sample rate** column of the project tree view, you can see the sample rates (data buffers) assigned to each variable (e.g., in Fig. 9-5 below).

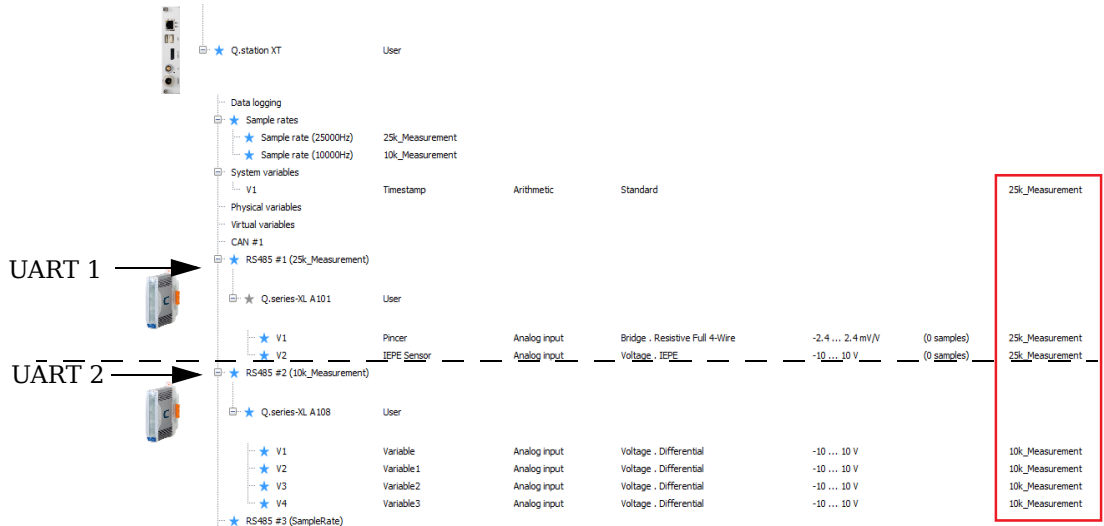

Fig. 9-5 Assigning Sample rate #1, 25k_Measurement, to UART1 and Sample rate #2, 10k_Measurement, to UART2

You may select the sample rate for each variable via any variable context menu: **Edit variable** > **Sample rate** (see Fig. 9-6).

Later in the logger settings only the channels are shown which are being acquired with the corresponding rate.

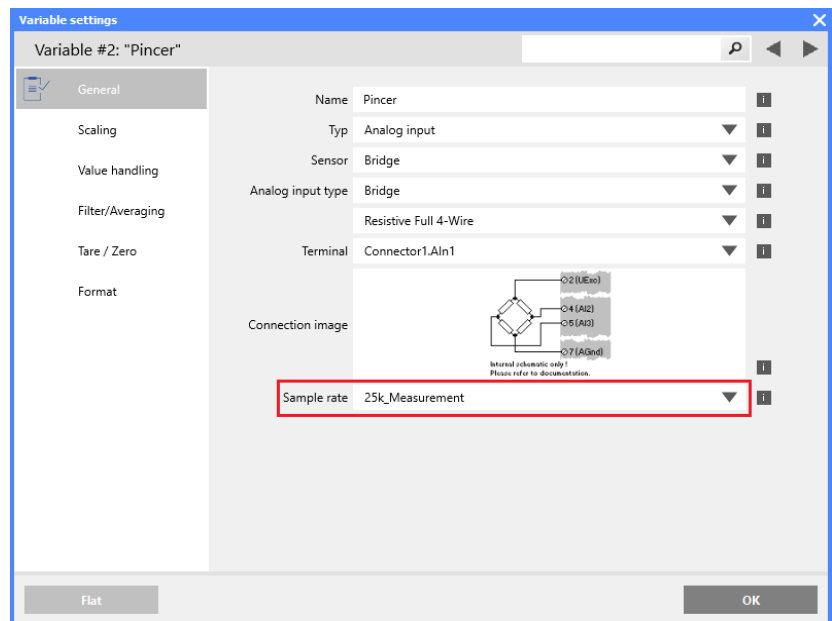

Fig. 9-6 Assigning Sample rate #1, 25k_Measurement, to UART1 and Sample rate #2, 10k_Measurement, to UART2

9.3

System (Data) Streams

As of *GI.bench* V1.3 Build 02, the appropriate *System stream(s)* is required within a project for data visualization and logging to be possible. Data loggers can be created on the controller level and on the PC level for the incorporation of additional sources of data. When using **Read** to add a connected Q.station X to a project, a prompt will request that you *Select streams for visualization*. All available data streams will be selectable within this window if connected (e.g. *DataBuffer #1* in Fig. 9-7).

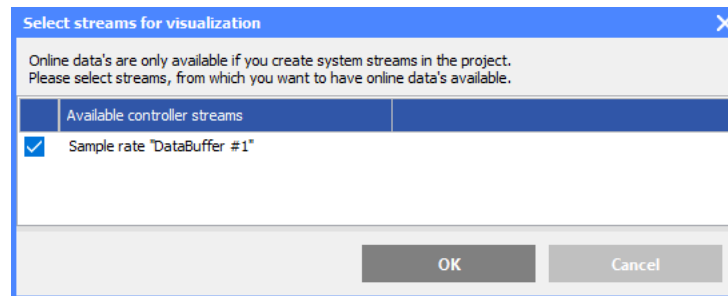

Fig. 9-7 Select data streams for Online visualization

If changes are made to the project after using **Read**, additional *System streams* may be necessary. To do this, select **Add system datastream** from the *System streams* context menu and refer to Section 9.3.1, *Stream Processor Settings* for more details. After adding all the necessary data streams to the project, the streams are selectable within **Data source** in the *Data logger settings* window (i.e. allowing you to select variables within loggers).

9.3.1

Stream Processor Settings

For **Datastream** options, refer to section Section 9.1.1, *Sample Rate Settings*, page 184 for descriptions of available settings.

Available variables in *Stream processor settings* depend on the variables previously assigned to the *Sample rate* defined in the **Stream** field within **Datastream** options in *Stream processor settings*. Select from the **Available variables** those to include in the data stream then click on **OK** to commit your changes.

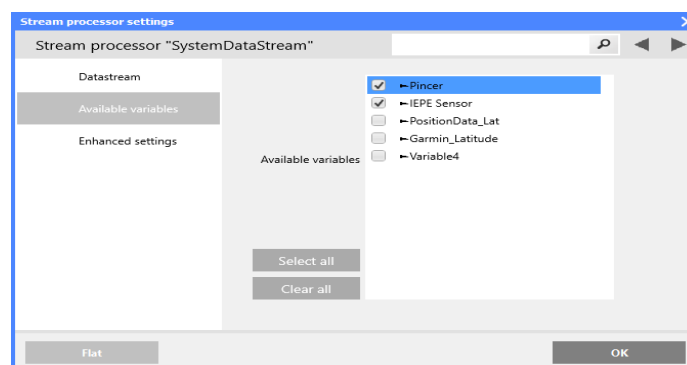

Fig. 9-8 Selection of only 2 variables for a data stream (buffer)

9.4

Data Logger Configuration

Q.station X data loggers can store recorded data in ASCII format to multiple file destinations. The rate at which data files are stored does not have to equal the configured sample rate.

Recorded values can be stored either internally or externally, as you can set the desired file storage destination during configuration. Data transmission to a host controller runs via Ethernet FTP (client and server) whereas the direct data extraction is best via the USB serial port. The automatic transfer of calculated data sets via serial or Ethernet FTP is possible in parallel to active data storage (logging).

Once the desired logger(s) are configured, access logger controls are via **Data acquisition > Logger (F6)** in *GI.bench*.

Create and Delete Loggers

Right-click on *Data logging* in a *GI.bench* project configuration tree to bring up the context menu and select **Add logger**. You may add up to 20 loggers for the Q.station X Test Controller.

To delete a logger, access the context menu of the desired logger and select **Delete logger**.

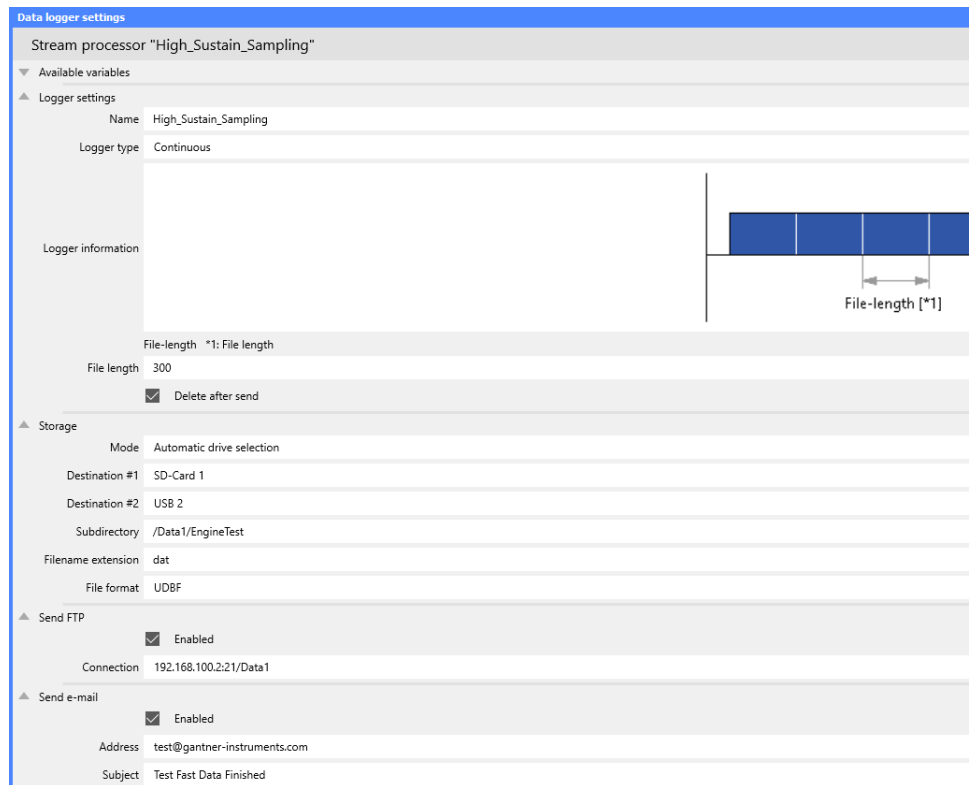

*Fig. 9-9 Example of a **Continuous** logger with redundant storage destinations in parallel with FTP and email data packages sent from the Q.station X*

9.4.1 Data Logger Settings

Data Source

Select here which data stream should be used for this logger. The variables saved are selected via the **Available variables**, see Fig. 9-11 below.

! **IMPORTANT**

Selecting a different data source resets all other settings of the data logger (right side).

Available Variables

Available variables in *Data logger settings* depend on variables previously assigned to the *System stream(s)* defined in the **Data source** field within the same settings

Logger Type

Choose between **Continuous**, **Triggered** and **Event based**. After selecting either **Triggered** or **Event Based**, additional options are displayed so that you can set the **Trigger** conditions.

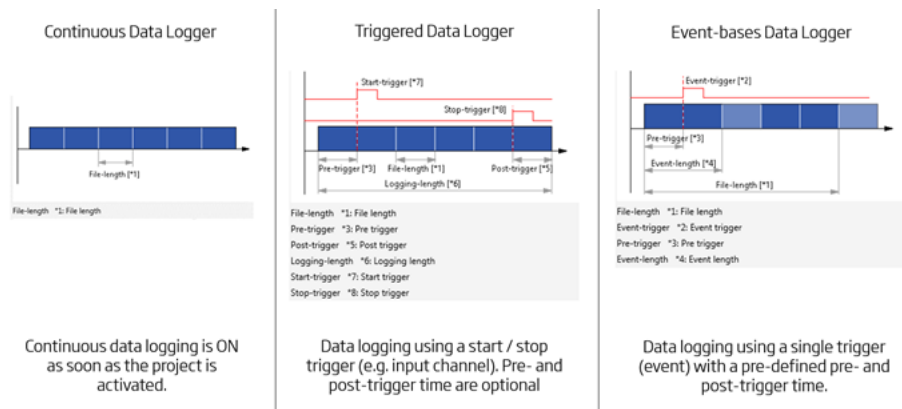

Fig. 9-10 Comparison of available logger types within GI.bench

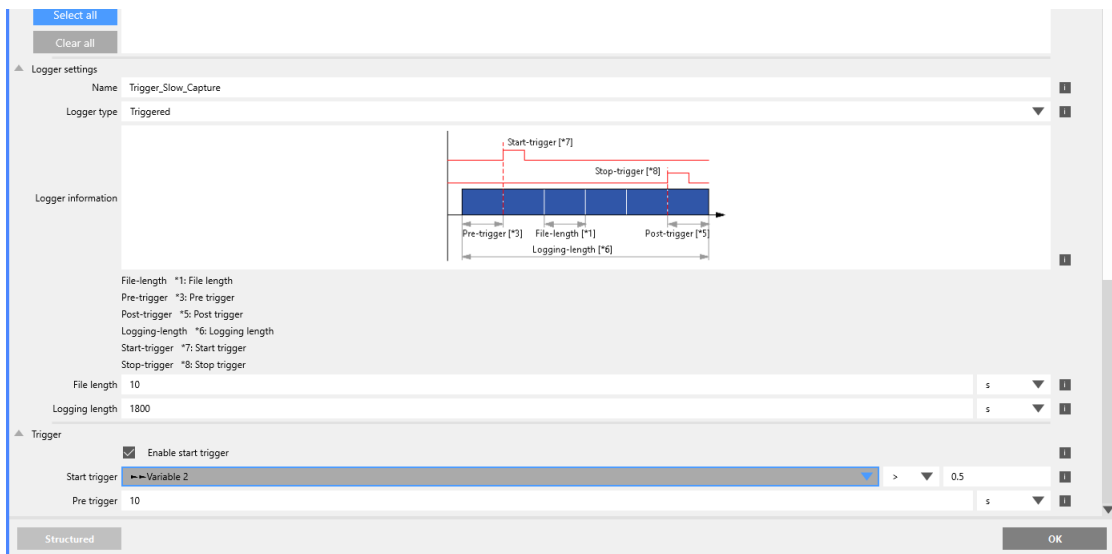

Fig. 9-11 Configuring a logger of type: Triggered

The specific settings for **triggered** or **event-based** loggers can be found in Section 9.4.5, *Trigger and Event Settings*, page 198.

Name

We recommend assigning a name that characterizes the purpose of the logger, e.g., **Slow_measurement** or **Force_trigger**.

By using placeholders in the logger name you can customize a suitable folder structure for your files. Specifying **%YYYY-%mm-%dd/%HH/SlowMeasurement** creates the following folder structure if the *first* measurement of the *first* file was acquired at 8am on 25.01.2014:

\2014-01-25\08\SlowMeasurement...

Available Placeholders

Placeholder	Definition	Example
%a	Weekday (abbreviated)	Thu
%A	Weekday	Thursday
%b or %h	Month name (abbreviated)	Aug
%B	Month name	August
%c	Date and Time	Thu Aug 13:55:02 2014
%C	Year (first two digits)	20
%d	Day (two digits)	23
%D	Date (short form)	02/23/14
%e	Day (two digits, leading space)	1
%F	Date (long form)	2014-02-23
%g	Year, week-based (last 2 digits)	14
%G	Year, week-based	2014
%H	Hour, 24-hour format	13
%I	Hour, 12-hour format	01
%j	Day of the year	235
%m	Month (two digits)	02
%M	Minute	55
%p	AM or PM	PM
%r	Time, 12-hour format	01:55:02 pm

Place-holder	Definition	Example
%R	Time, 24-hour format	13:55
%S	Seconds	02
%T	Time according to ISO 8601	13:55:02
%u	Day of the week according to ISO 8601 (Monday = 1)	4
%U	Calendar week (Sunday of the first week = 1)	33
%V	Calendar week according to ISO 8601	34
%w	Day of the week as a number (Sunday = 0)	4
%W	Calendar week (Monday of the first week = 1)	34
%y	The last two digits of the year	14
%Y	Date	2014
%z	Time offset from UTC time to ISO 8601 in minutes	+100
%Z	Time zone (name or abbreviation)	CDT
%%	Percent sign	%

9.4.2

Available Variables

All channels which operate within the sample rate (data buffer) selected at **Data source** are displayed. Select those which are to be recorded by this logger.

- **Available variables** in *Data logger settings* depend on the variables previously assigned to the *System stream(s)* defined in the **Data source** field within the same settings.
- **Available variables** in *Stream processor settings* depend on the variables previously assigned to the *Sample rate(s)* defined in the **Stream** field within the *Datastream* options of the *Stream processor settings* window.

9.4.3

Data Logger Settings Continued

You will find the special settings for triggered or event-based measurements in Section 9.4.5, page 198; the settings valid for both logger types are explained in the following.

9.4.3.1

File Length

Depending on the logger type, you can specify the size of a file as the number of data records, in seconds, bytes or as a number of events. A data record corresponds to *one* measurement over *all* channels activated at **Available variables**. When the specified value is reached, a new file is started if the recording has not yet finished.

! **IMPORTANT**

Up to 10,000 files can be saved on a storage medium.

- ➔ A file size defined as “rounded time” ensures that individual logger files start recording at rounded start times. For this to be possible, the first recorded file may be shorter in duration than configured to achieve the proper start times and durations for subsequently recorded logger files. For example, if a logger begins recording at 13:33:43h with a rounded file size of 150 seconds (or 2.5 minutes), then the first logger file produced contains data up to 13:36:00h (for a 2.28 minute total duration). The second data logger file would then have a start time of 13:36:00h, and all subsequently created logger files would then contain the full 150 seconds of data. The file size can also be configured with a duration in minutes rather than seconds. However, a file size of 55 seconds is not rounded to 60 seconds as the resultant file size can only be rounded down to the nearest minute. In this case, the produced logger files all begin at unrounded start times.

The file name is formed from the logger name and the date and time of the *first* measurement. Using placeholders in the logger name, you can define a suitable folder structure for your files; refer to *Name*, page 191.

9.4.3.2

Event Length

This setting is only available with the **Event based** logger type. You define over how many data records, how long or how many bytes per event are to be logged. A data record corresponds to *one* measurement over *all* channels activated at **Available variables**.

9.4.3.3

Logging Length

This setting is only available with the **Triggered** logger type. You specify the total time over which logging is to occur. The setting is independent of the size of the single file, i.e. it can be smaller or larger. If the value for the **Logging length** is greater than the size of the single file, then several files are written.

9.4.3.4

Mode

The type of storage determines how and in what sequence writing occurs to the target memories specified in the following. Now you have basically four options:

Store to New Connected Drive

Storage of the data occurs on the first available data medium with the file size specified under **File length**. If no further space is available here, the oldest two files are deleted and overwritten with new data (one file more is always deleted than written new in order to maintain a reserve).

When you connect a second data medium, the storage on the active data medium is terminated immediately and is written to the new data medium. You can remove the old data medium once the blue LED (RUN) no longer flashes rapidly (storage has then terminated). Otherwise the copied files may be damaged, refer also to Section 4.4.1.2, *Storage to External Memory Device is Active*, page 31. This means that you can write alternately to two storage media, e.g. an external hard disk and a USB storage medium.

Automatic Drive Selection

Storage of the data occurs on the first available data medium in the list with the file size specified under **File length**. If no further space is available here, the next data medium in the list is used. If all available data media are full, the oldest two files in all data media are sought. They are then deleted and the relevant data medium is used further. The oldest files of this data medium are always deleted and overwritten with new data (one file more is always deleted than written new in order to maintain a reserve). With this option all the specified data media are used like a single large ring buffer.

To prevent the loss of data you have to read out the data *via the network* before overwriting.

Moving Files

Storage of the data occurs on the specified data medium with the file size specified under **File length**. If no further space is available here, the oldest two files on this data medium are deleted and overwritten with new data (one file more is always deleted than written new in order to maintain a reserve).

When you connect another data medium, the data are moved onto this data medium, i.e. they are deleted on the original data medium. The transfer is indicated by rapid flashing of the blue LED (RUN). You can remove the data medium once the blue LED no longer flashes rapidly. Otherwise the copied files may be damaged, refer also to Section 4.4.1.2, *Storage to External Memory Device is Active*, page 31.

Copying Files

Storage of the data occurs on the specified data medium with the file size specified under **File length**. If no further space is available here, the oldest two files on this data medium are deleted and overwritten with new data (one file more is always deleted than written new in order to maintain a reserve).

When you connect another data medium, the data are copied onto this data medium, i.e. they are retained on the original data medium and are not deleted as in the case of . With the selection of **only new data** only the data which has not yet been copied are copied onto the newly connected data medium.

The copying process is indicated by rapid flashing of the blue LED (RUN). You can remove the data medium once the blue LED no longer flashes rapidly. Otherwise the copied files may be damaged, refer also to Section 4.4.1.2, *Storage to External Memory Device is Active*, page 31.

Protected Mode

The protected mode prevents unauthorized reading of your data. For this you need a special data medium (USB which is coded to the Q.station X).

If this is required, contact (refer to Chapter 12, *Sales & Service Information*, page 223), who will then produce an appropriate file for your storage medium using the details you provide. After selecting this option, the data are only transferred when a data medium coded in this way is connected. No data is transferred when another data medium is connected.

9.4.3.5

Destination #1

Storage of the data always takes place on the specified data medium or on the first available medium where there are several media. The maximum size of the **internal Drive** (hd0) is 1 Gbyte.

- ➔ We recommend that the internal memory is only used for low data rates (100Hz), because the number of measurements which can be saved per second is relatively low.

Otherwise select a fast SD card, USB drive, or network drive to maximize local or internal storage rates.

! IMPORTANT

If only one medium is specified, this medium must not be removed as long as one of the loggers is active. Otherwise data may be lost. With storage on USB make sure that the correct USB interface is specified (refer to Fig. 4-1, page 23).

! IMPORTANT

Up to 10,000 files can be saved on a storage medium.

To facilitate the connection of several USB data storage media via a USB hub, you can select various ports for the relevant USB interface, e.g., **USB 1.1, 1.2, 1.3, 1.4**, and **1.5** are *USB 1 Ports 1 to 5*.

As in Section 7.1.3.4, page 148, if you have defined one or several network drives, you can also define them as the target memory: select the **Name** specified there.

9.4.3.6

Send Data to FTP Server

In order to be able to send data to an FTP server, you must first define the data for the FTP server(s) within *Controller settings*; refer to *Client settings* in Section 7.1.3.3, page 146. The data are sent when the **File length** is reached.

Select the FTP server after activating (**Enabled**) the **Send FTP** option within *Data logger settings*.

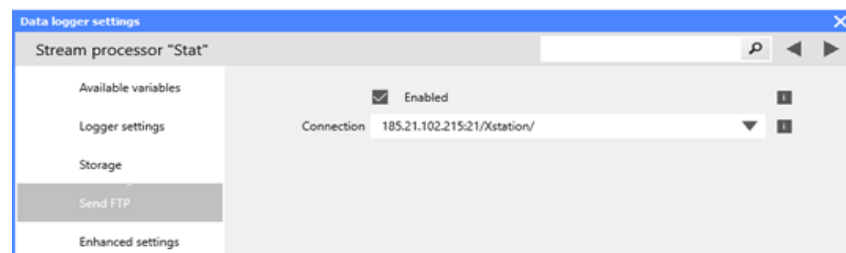

Fig. 9-12 Send data to an FTP server

i Tip

Using the variable *SendFTPVirtualBufferFile*, you can trigger the sending of a file to an FTP server. In this case you can leave the entry shown in Fig. 9-12 blank.

9.4.3.7

Send Data via E-mail

In order to be able to send e-mails you must pre-configure E-mail selections that would be available in fields **Address**, **Subject** and **Body**; see Section 7.1.3.6, page 149. The E-mail is sent when the **File length** is reached; the file is sent as an attachment.

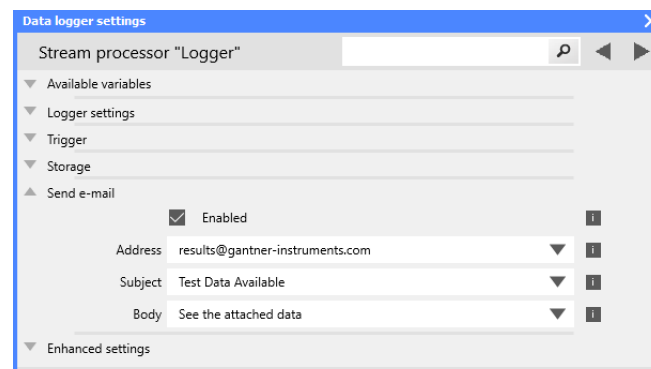

Fig. 9-13 Configuring logger to send an e-mail

Activate email functionality via **Enabled** and select one of the pre-configured settings for the **Address**, **Subject** and **Body** (e.g., Fig. 9-13).

9.4.4

Enhanced Settings

With the expert settings you can perform various general settings for any data logger. The default settings are suitable for most applications, so only change them if necessary.

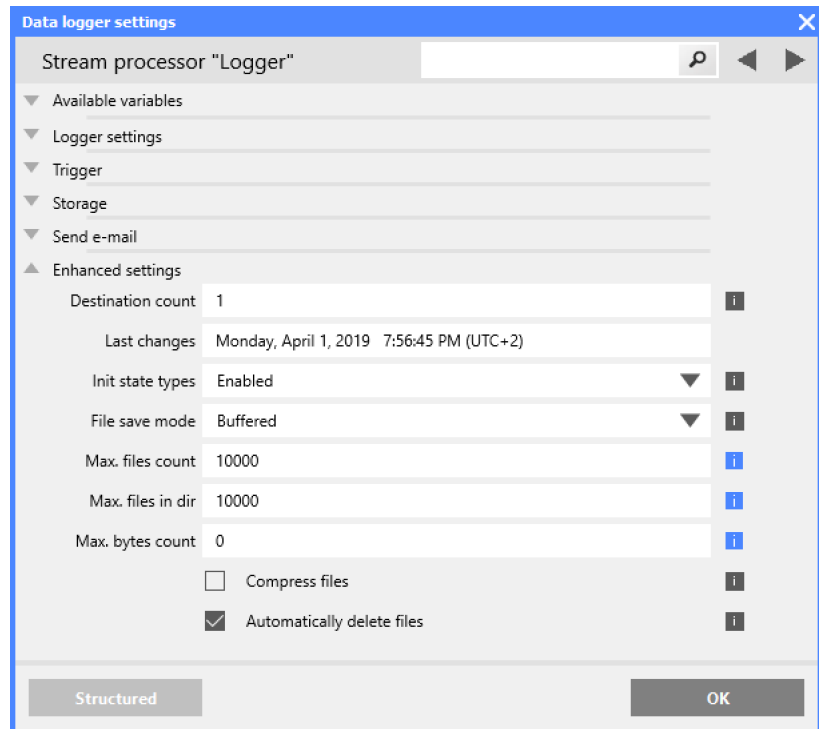

Fig. 9-14 Expert settings

File Save Mode

The **Buffered** setting offers the fastest speed, but the operating system decides when writing is to occur. In the settings with **O-direct**, writing takes place directly without a buffer where possible, **Sync** synchronizes the complete file system directly after every time writing to a file occurs (directory structure) and **F-sync** only synchronizes the written file (updating where the file is located on the storage medium).

Init State Types

This basically corresponds to the setting of the logger status. In the **Single shot enabled** mode the logger is only activated once at the trigger event. Depending on the setting for the Size, several files are also recorded as long as the trigger event is present. After recording, the logger is deactivated in this mode and another trigger event is not awaited.

➔ You can also activate or deactivate the logger (again) in **Single shot** mode via arithmetic function **InternetLoggerControl**.

Max. Files Count

This defines how many files can be created as a maximum by this logger (0 to 4,294,967,295). The default setting is 10,000.

Max. Files in Dir(ectory)	This restricts the number of files which can be created in a directory. The default setting is 10,000.
Max. Bytes Count	With this setting you can restrict the space in bytes available to this logger (0 to approx. $1.8 \cdot 10^{19}$, longest 64-bit integer number). Specifying 0 (default setting) corresponds to no restriction.
Automatically Delete Files	This deletes the oldest files once the space available on the storage medium has been occupied.

9.4.5

Trigger and Event Settings

IMPORTANT

You must *measure* the channel used for the trigger condition or the event or the condition variable with the logger sample rate (same data stream). The channel must therefore be listed and activated in the section **Available variables**.

The difference between **Event-based** and **Triggered** is that with **Triggered** both start and stop occur via a trigger event, whereas with **Event-based** only the start is initiated by an event (triggered) and a stop trigger does not exist: The quantity of data specified under **Event length** is always recorded.

Start-Trigger, Event

You can specify a channel or a computation as the **Condition** for the trigger. This can also be a channel, for which writing into the variable occurs, e.g. via EtherCAT from a PLC or from *test.con*. Click on the entry field to call the dialog for input. The field is displayed with a red font as long as no condition or an invalid one is specified. Specify whether the variable has to exceed (>), undercut (<), be greater than or equal to (>=), be less than or equal to (<=), be identical to (==) or only not the same as (!=) the specified value, so that the trigger or event is initiated.

IMPORTANT

The start trigger must also be recorded.

Stop-Trigger

Click on **Stop trigger** to change over between **Condition** and **None**. In the **None** setting storage is terminated when the **storage length** is reached.

You can specify a channel or a computation as the **Condition**. This can also be a channel, for which writing into the variable occurs, e.g. via EtherCAT from a PLC or from *test.con*. Click on the entry field to call the dialog for input. The field is displayed with a red font as long as no condition or an invalid one is specified. Specify whether the variable has to exceed (>), undercut

(<), be greater than or equal to (>=), be less than or equal to (<=), be identical to (==) or only not the same as (!=) the specified value, so that the trigger is initiated.

! **IMPORTANT**

The stop trigger must also be recorded.

Pre-Trigger

Using a pre-trigger you can define that a certain time is also recorded before the occurrence of the above defined start event. The figure can be given in seconds or as a number of data records. Click on **Pre-trigger** to switch the option on or off.

! **IMPORTANT**

The pre-trigger must fit into the buffer specified for the sample rate; refer to Size (Data Buffer), page 185.

When you specify a pre-trigger, values are continuously recorded in the internal memory. If the condition is fulfilled, the data present here is stored in the logger file.

Post-Trigger

Here specify whether recording is to continue after the stop signal. The figure can be given in seconds or as a number of data records. Click on **Post-trigger** to switch the option on or off.

! **IMPORTANT**

With repeated measurements the pre-trigger condition is only evaluated again after the post-trigger has run.

Event Length

This setting is only available with the **Event-based** logger type. You define over how many data records, how long or how many bytes per event are to be logged. A data record corresponds to *one* measurement over *all* channels activated at **Available variables**.

Storage Length

This setting is only available with the **Triggered** logger type. You specify the total time over which logging is to occur. The setting is independent of the size of the single file, i.e. it can be smaller or larger. If the value for the **Storage length** is greater than the size of the single file, then several files are written.

10

Access Data on Q.station X

You have options when attempting to access recorded data from the Q.station X or operate the Q.station X remotely:

1. From a connected PC, access the Q.station X the connected drives, e.g., Q.station X internal memory, **hd0**, through the network and use of SMB/CIFS.
2. You can remotely control the Q.station X through VNC, e.g. using a VNC viewer.
3. You can transfer the data from the Q.station X to an FTP server; refer to FTP client in Section 7.1.3.3, page 146.

10.1

Access Data via SMB/CIFS

10.1.1

Using Windows Explorer to Connect to Q.station X

SMB is a network protocol used by Windows-based operating systems that allows external devices within the same network to share files. Effectively, SMB allows computers connected to the same network or domain to access files from other local computers as easily as if they were on the computer's local hard drive.

Common Internet File System (CIFS) is a network protocol used to provide shared access to files and printers between machines on the same network. A CIFS client application or device can read, write, edit, and even delete files on a remote server.

You can utilize the above network protocols to effectively access the Q.station X Test Controller and its connected drives (both internal and external, e.g., SD card and USB drive, respectively) to read, edit, or delete stored data files, such as Universal Data Bin File or UDBFs (.dat files) from a data logger.

The following are the necessary steps to establish a SMB/CIFS connection between the Q.station X Test Controller and a PC:

Enter the IP address of the Q.station X that is connected to the PC in Windows Explorer (Fig. 10-1) and press ENTER. Use the proper syntax, e.g., **\\192.168.100.13** shown below.

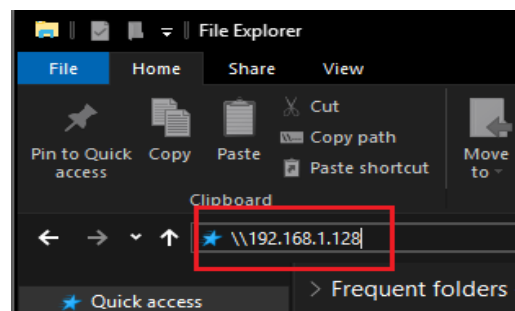

Fig. 10-1 Search for the Q.station X IP address via connected PC

If properly connected to the network and thus PC, the Q.station X appears in the window as a connected network drive (Fig. 10-2).

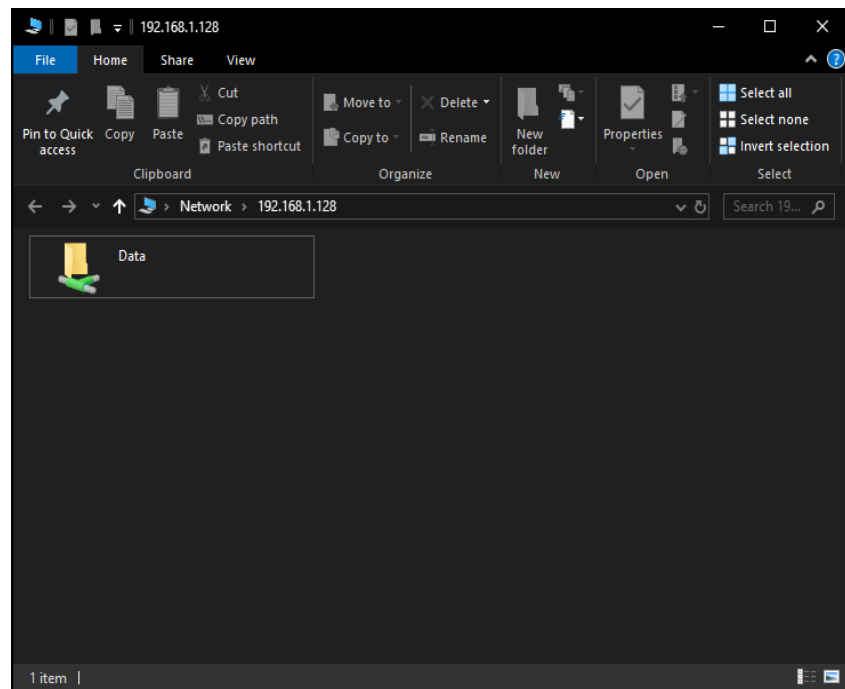

Fig. 10-2 Q.station X as network drive on same network as PC

You must enter the user name and password to be able to access the **Data** directory. Simply double click on the Data directory to open (the Data directory is shown) and double click on this directory (Fig. 10-3). In the following prompt, enter username (**data**) and password (**ginsdata**), then click **OK**.

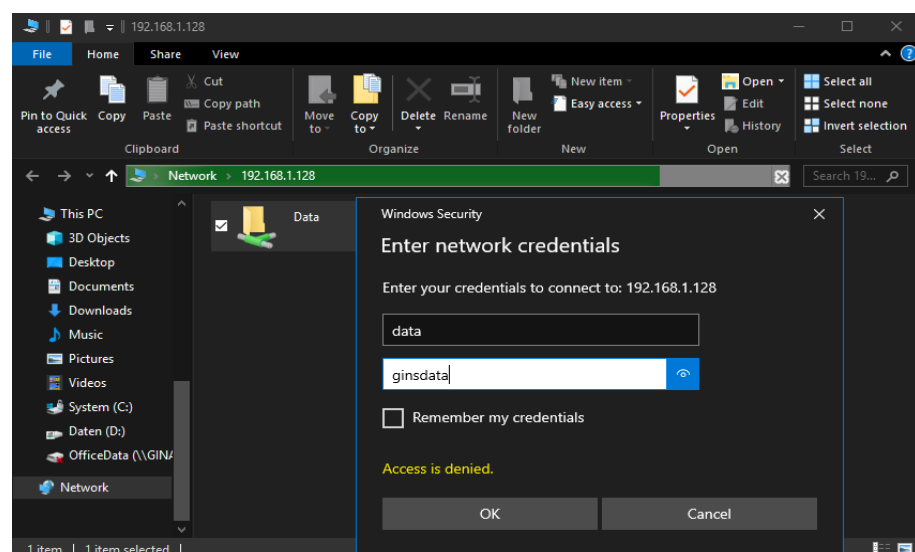

Fig. 10-3 Attempting to log into the Data directory of Q.station X

! IMPORTANT

If you are a member of a domain, Windows may assume that you are attempting to log onto the current domain. In this case, make sure to specify “\data” as the username to bypass the prefixed domain. Refer to Fig. 10-4 below for an example of a login entry.

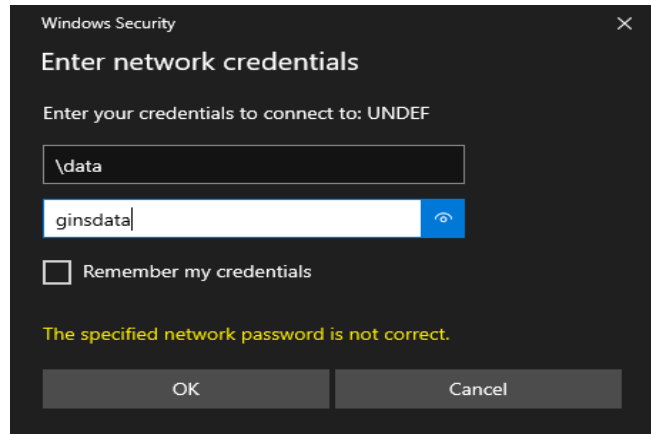

Fig. 10-4 Login attempt to Data directory as member of domain

In either case, after successfully logging into the **Data** directory, access to the **hd0** directory is granted (Fig. 10-5), just like any internal hard disk drive of the PC.

Now copy or move files freely from the Q.station X.

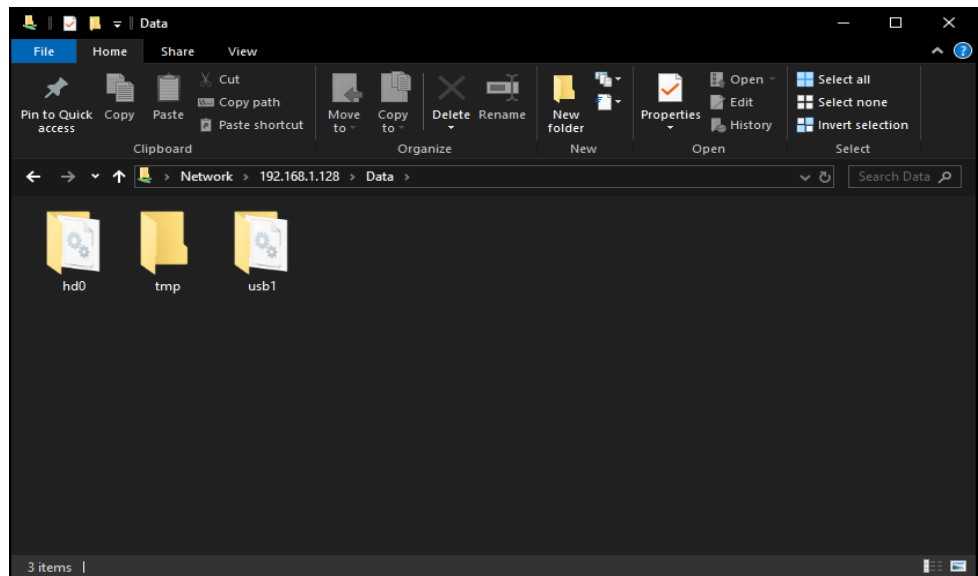

Fig. 10-5 Access to the Q.station X as network drive with internal and external storage directories to retrieve or view data

10.1.2

Mapping the Q.station X as a Network Drive

Alternatively, to establish a SMB/CIFS connection between the Q.station X Test Controller and PC, right-click on **Network** -> **Map network drive** in any *Windows Explorer* navigation pane (Section 10-6, page 204).

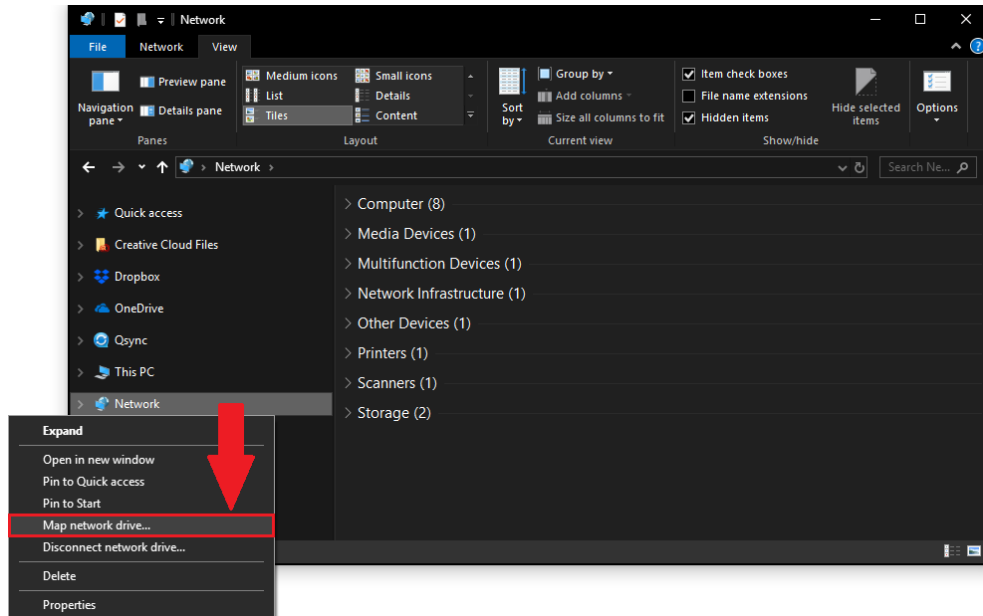

Fig. 10-6 Mapping the Q.station X as a network drive for the PC

By mapping a network drive to a PC, that drive is selectable from the *Windows Explorer* navigation pane at any time. Select the designation for the drive, (e.g., drive Y:) and enter the IP address of the Q.station X, with syntax as shown below in Fig. 10-7.

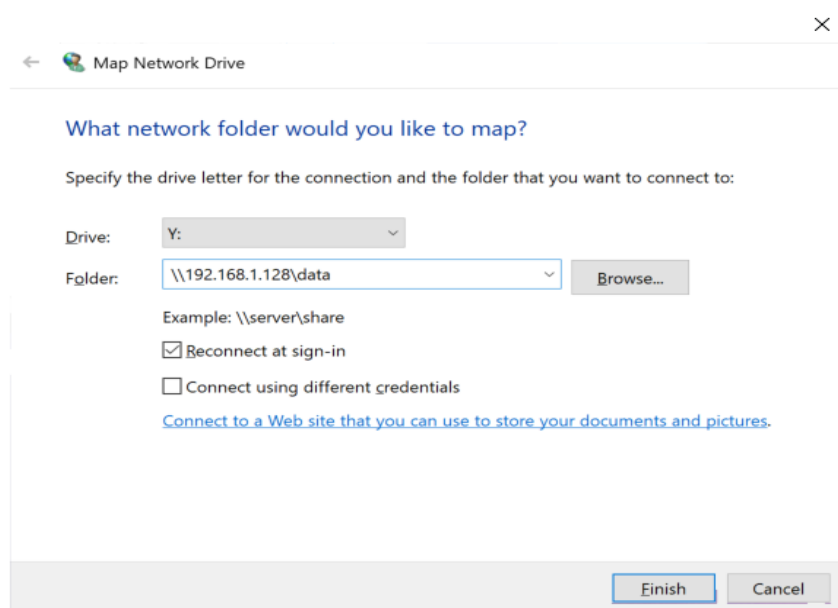

Fig. 10-7 Mapping Q.station X **Data** directory to the **Y:** drive

If using the syntax for the Q.station X IP address as shown in Fig. 10-7, page 204, an attempt to login to the Q.station X will present the login window (e.g., Fig. 10-3, page 202), in which you have to enter the user name (**data**) and password (**ginsdata**) unless behind a domain, in which the user name is **/data** instead, as shown in Fig. 10-4, page 203.

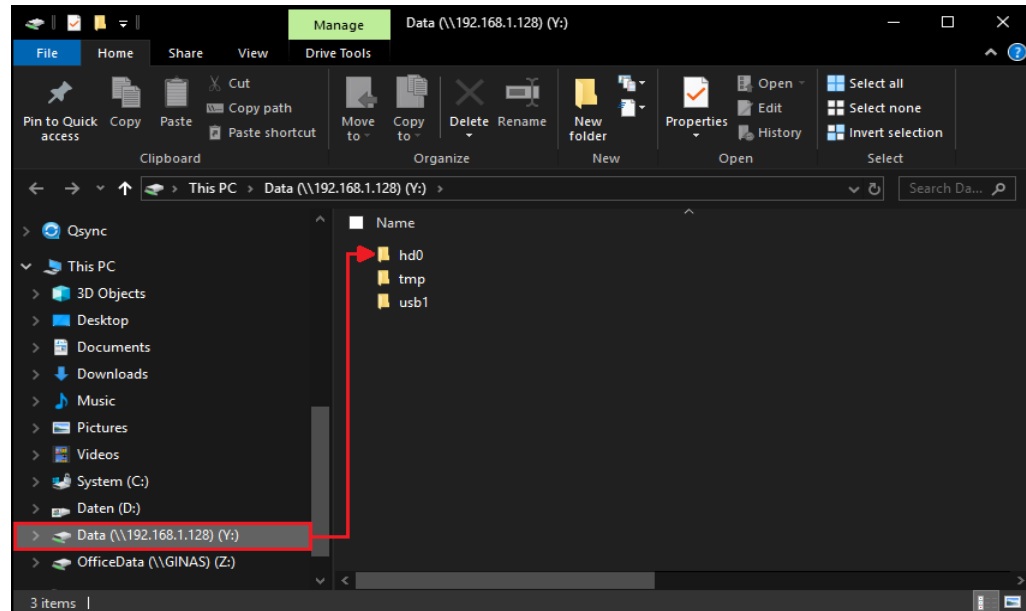

Fig. 10-8 Drive Y: contains the Q.station X internal memory **hd0**

After successfully logging into the **Data** directory in this manner, access to the **hd0** directory is granted (Fig. 10-5). Similar to any network drive, once mapped, the Q.station X will be saved as a network drive for quick access any time from within the network (i.e., listed under **This PC** as shown in Fig. 10-8).

Now you may copy or move files freely from the Q.station X.

10.2

Remote Control Q.station X via VNC

The following section explains how to establish a remote control session with the Q.station X via PC using *TightVNC*

- ➔ *TightVNC* is freeware under GNU General Public License V2. *Freeware* is software that is distributed at no cost to end users.

Download the program *TightVNC* to your computer via:
<http://www.tightvnc.com/download.php>.

- ➔ Ensure that the appropriate operating system (32- or 64-bit) is chosen for download.

Install using the *TightVNC* Setup program (see Fig. 10-9).

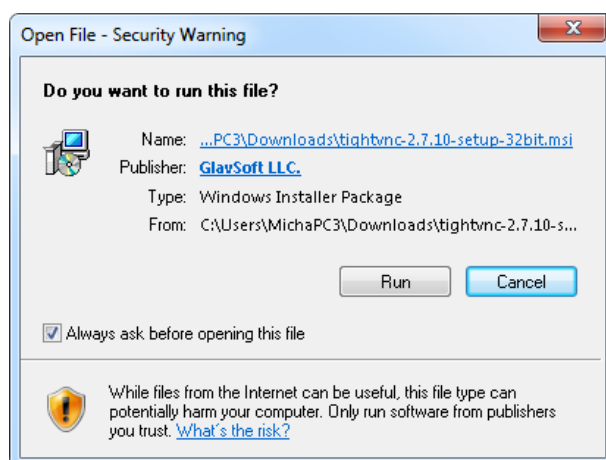

Fig. 10-9 Installing *TightVNC* to a PC to gain access to Q.station X

Only *TightVNC Viewer* is needed to be able to remotely operate the Q.station X. To modify the installation accordingly, select the installation type **Custom** (Fig. 10-10).

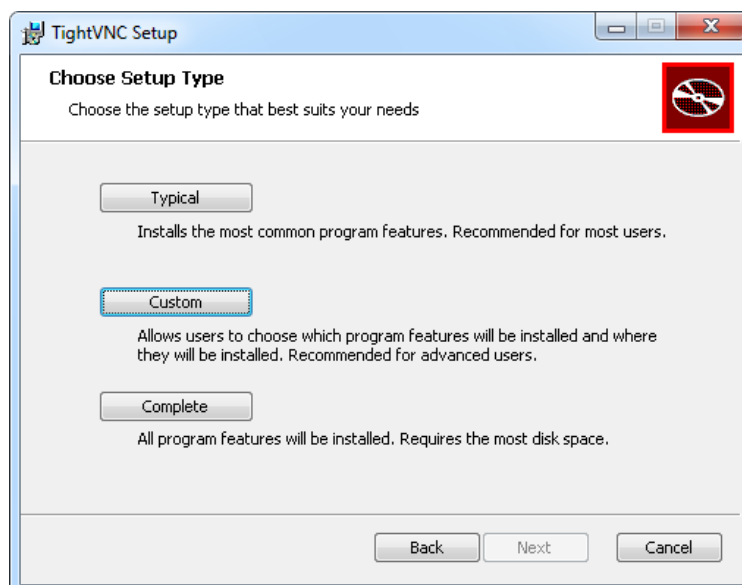

Fig. 10-10 Custom installation in *TightVNC* Setup program

Using the **Custom** Installation type, you will have the option of installing only the *TightVNC Viewer* (Fig. 10-11).

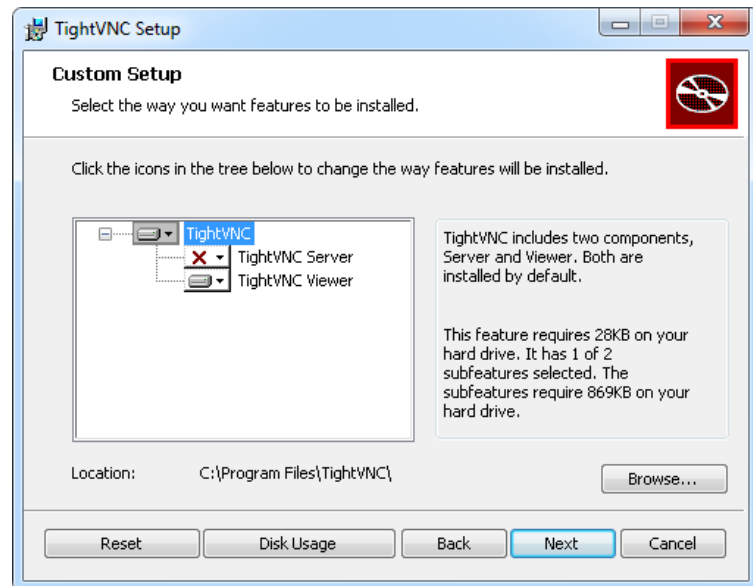

Fig. 10-11 Installing only the *TightVNC Viewer* program

Follow the remaining instructions provided by the Setup program to complete the installation progress and continue to next steps. Once the installation is complete, start *TightVNC Viewer*. The window for configuring a *New TightVNC Connection* will appear.

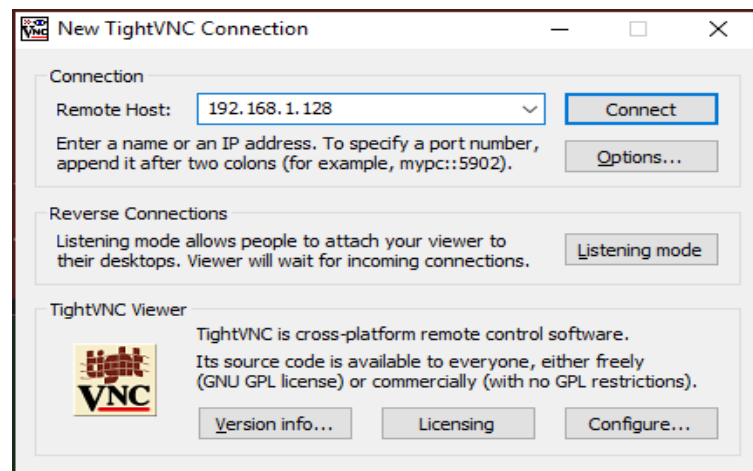

Fig. 10-12 Logging onto the Q.station X via *TightVNC Viewer*

Enter the IP address of the Q.station X Test Controller into the **Remote Host** field (Fig. 10-12). Once used to login successfully at least once, the IP address will appear in the **Remote Host** drop down menu for future login attempts. After entering the IP address, click on **Connect**.

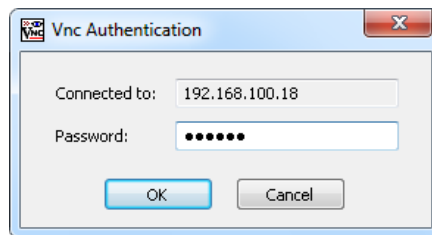

Fig. 10-13 Entering the password 'master' for access via VNC

In the next window, enter the password **master** (Fig. 10-13). If successful, *TightVNC Viewer* will present the following screen (see Fig. 10-14 below). At this point, use a mouse or touchscreen to select the desired tiles and operate the Q.station X remotely.

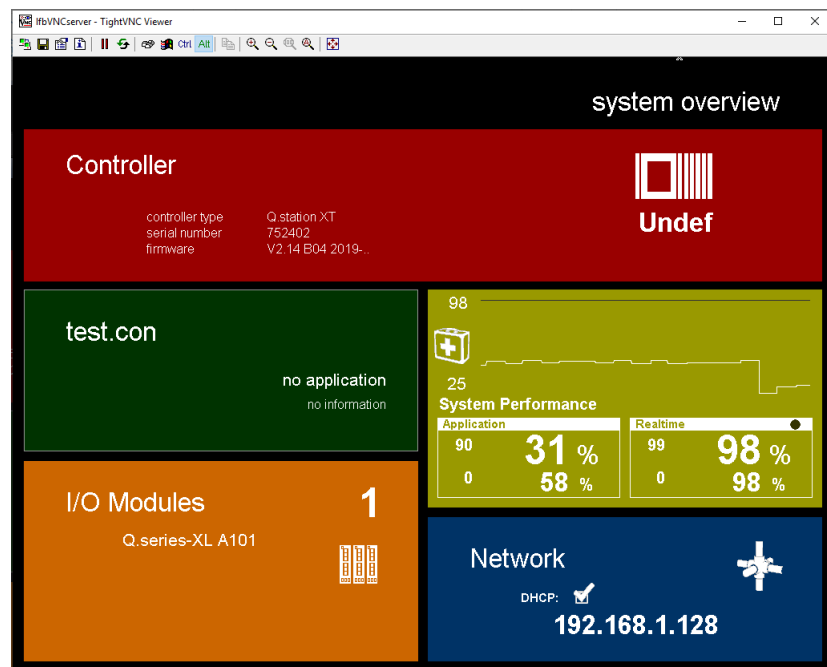

Fig. 10-14 Remote control of Q.station X via TightVNC Viewer

Other VNC viewers can work as well. Enter the requested login data as described above per the program used.

i Tip

Q.station X provides an additional solution for remote access and operation: an integrated *web server* (Section 10.3, page 209).

10.3

Remote Control Q.station X via Web Server

This section explains how to establish a remote control session with the Q.station X via PC using the integrated Web Server.

A web server is either server software or the hardware dedicated to running the server software that is capable of satisfying client requests received from the *World Wide Web*. A web server can process incoming network requests over HTTP as well as several other related protocols.

To gain access to the Q.station X via the integrated web server, simply open your preferred web browser and enter the IP address of the Q.station X using the appropriate syntax (e.g., Fig. 10-15).

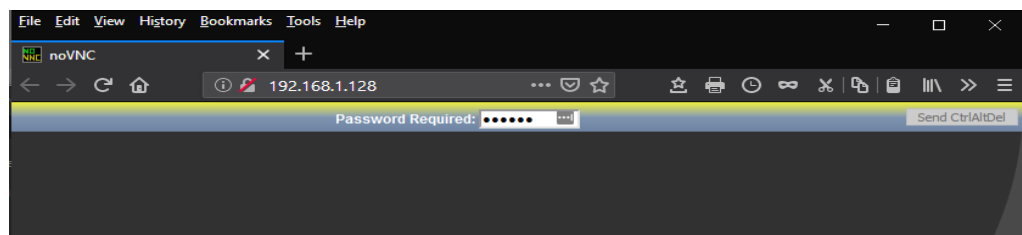

Fig. 10-15 Using browser to connect to Q.station X web server

After attempting to connect to the IP address via web browser, the login web page will appear as shown in Fig. 10-15.

Enter the password **master** to connect to the Q.station X.

If successful, the web browser will present the following screen (e.g., Fig. 10-14). At this point, use a mouse or touchscreen to select the desired tiles and operate the Q.station X remotely.

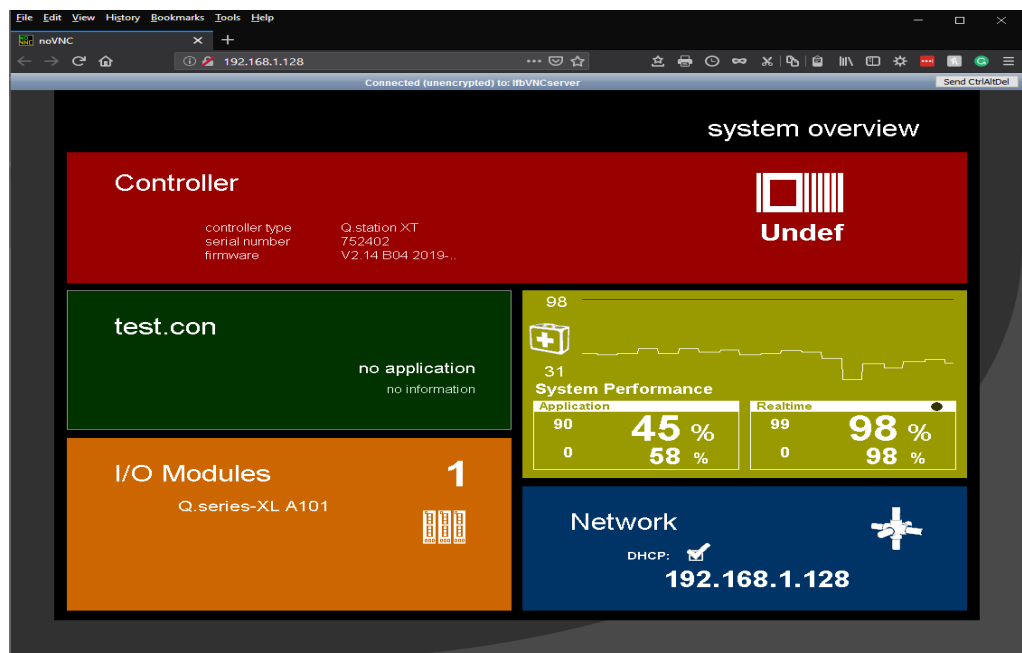

Fig. 10-16 Remote control of Q.station X via web server in browser

11

Functional Procedures

This chapter explains various topics and procedures that are either referenced or previously mentioned in the manual, only more comprehensively, e.g., providing supplemental information for various interface parameters, module configurations, and information related to sensor setup.

11.1

Using Serial Interfaces

The serial interface on the Q.series XL modules is based on the RS-485 standard. This means that data transmissions over distances of up to 1 km and the connection of *several* devices to a *single* interface is possible; the RS-485 interface is therefore a bus-type interface. With the Q.series XL up to 16 modules can be connected to each bus line.

PCs might only be equipped with one RS-232 (DB9) interface, which according to the standard, a maximum bus line length of 20m is admissible and only one device can be connected per interface. Therefore, for communication with the Q.series XL modules to be possible, you need either an RS-485 interface card in the PC or an interface converter, e.g., *ISK-101* for RS-232 to RS-485 via 9-pin D-SUB connector or *ISK-103* for USB to RS-485.

A particularly important feature to facilitate large line lengths: *activating bus termination*. Bus termination comprises of a DIP switch setting on the socket that introduces resistances to the end of bus lines, preventing reflections that can occur on the bus (i.e., the resistances attenuate the signal at the end of the line.)

You will find additional information on the above topics and on connection techniques within the following sections.

11.1.1

Interface Converters

You may connect interface converters to a device with compatible RS-232 interfaces, e.g., a PC, and communicate with Q.series XL modules via the RS-485 interface (UART).

Gantner Instruments offers two interface converters for use with Q.series XL measurement modules:

1. The ISK-101, for interfacing with DB9:
Facilitates a connection of RS-232 (DB9) on the PC to RS-485 interface (UART) on the module via a 9-pin D-SUB connector. Terminating resistance is located in the connecting plug and is always active.
2. The ISK-103, for interfacing with USB:
Facilitates a connection of RS-232 (USB) on the PC to RS-485 interface (UART) on the module. Terminating resistance is located in the connecting plug and is always active.

11.1.2

Connection Technology

If strong ambient electrical interference is anticipated, as is often found in industrial facilities, we recommend shielding all bus and sensor lines (cables). For bus devices such as controllers (PLC), computers (PC), repeaters, or interface converters, the shield is usually produced by the earth conductor and in some cases, with use of special chassis ground buses. Generally, you should always wire a shield to an earth conductor or housing and *not* to circuit ground. If it is necessary, the shield can be connected to an earth conductor several times along the length of the cables to achieve *Potential Equalization (PE)*. For short bus line distances, e.g. stub lines, better results are often achieved when a shield is only connected to the end of the stub line.

With a shield, the interference signals are diverted to the earth conductor before they can penetrate into the modules producing disturbances such as noise. The cable shield is connected via the terminal for *Potential Equalization (PE)*, available via the *POWER* interface on a Q.station X Test Controller (see Fig. 4-1, page 23).

11.1.3

Network Topologies

When setting up Gantner system networks, various structures, or topologies, are possible due to flexibility in distribution. When connecting several Q.series XL modules to a Q.station X Test Controller, a line bus structure for is required (Fig. 11-1, page 212). Up to four “bus lines” or UARTs of modules can be connected simultaneously to the Q.station X (Fig. 11-2, page 212) either in series with Q.bloxx X Extension Socket (QXES) or distributed.

Other topologies, e.g., the tree structure in Fig. 11-3, page 213 while used with an Ethernet connection, is not possible.

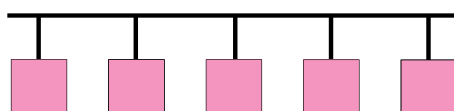

Fig. 11-1 Example of “Line” bus structure without Q.station X

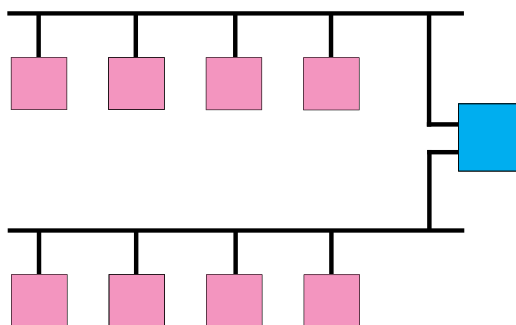

Fig. 11-2 Two parallel bus lines (UARTs) connected to Q.station X

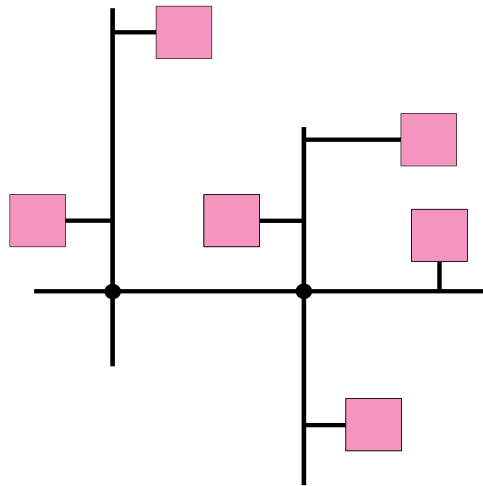

Fig. 11-3 An example of an invalid distributed "Tree" bus structure

11.2

Connecting Transducers with Sensing Leads

Resistive sensors require an excitation voltage to output a signal. In order for sensor excitation to occur, a current must pass through the connecting cable. This however causes a loss of voltage proportional to the length of the cable due to the resistance within the cable. In this situation, the connected sensor is typically not supplied with the exact voltage set on the connected amplifier module but more often with a slightly lower voltage due to voltage losses over the length of the cable used. This results in a lower output signal from the sensor and depending on the cable's resistance, can result in measurement losses within the single-figure percentage range even when using just a few meters of cable.

High quality amplifier modules for the excitation of resistive sensors utilize sensing leads which can measure the loss of voltage over the length of the cable due to the low current flowing through them. This is due to the inputs on the sensing leads typically having high input resistances (usually over $10^6 \Omega$ compared to a typical sensor's resistance of a few 100Ω). Therefore, such amplifier modules can acquire the voltage arriving at the sensor error-free and increase their excitation voltage to compensate for the voltage loss due to cable resistance. These sensing leads are particularly necessary when the temperature of the connected cable can change throughout a measurement. In this situation, the cable resistance changes during a measurement as well and in turn the sensor output signal would also change if no sensing leads were used.

We therefore strongly recommend the use of sensing leads for use with sensors that require an excitation voltage in order to output a signal. They are especially necessary when several meters of cable are expected to be used in your application, if low measurement deviations are expected to be obtained or if the temperature of the cable may vary during measurement.

11.3

Sensor Scaling in GI.bench

Depending on the type of transducer (or sensor) used, there are various possible scaling configuration options available to you. For voltage signals and strain gages (bridges), you may define the conversion of the measured voltage signal (V or mV/V) into an available physical unit of your choosing, e.g. Newtons, from the drop down menu in the **Unit** field. A list of the available units in *GI.bench*, refer to Section 11.4, page 219.

The units for any measurement can be changed and scaled freely in *GI.bench*, i.e. any custom unit with a digit length of 6 or less characters is valid. Simply type the desired custom designation in the **Unit** field under the **Scaling** category in the *Variable settings* window in *GI.bench*. In the case of strain gages, a special tool called the **Strain Gage calculator** is also available to you (e.g., Fig. 11-6, page 217). Refer to Section 11.3.2, page 217 for more information regarding the **Strain Gage calculator**.

In *GI.bench*, right-click on the variable that requires scaling and select **Edit variable** to open the variable settings window (refer to Fig. 11-4 below. Alternatively, double click on the variable.



Fig. 11-4 Scaling options for voltage using Factor and Offset

11.3.1

Scaling Voltage Signals and Strain Gage Bridges

1. In the **Scaling** options of the *Variable settings* window in *GI.bench*, there is a **Unit** field where you can define a required physical unit, e.g. **N**. The units available via the drop down menu may be limited to selections of scaled variants of the base unit of the **Analog input type** defined in the **General** options. Access available units by clicking on the down arrow in the **Unit** field. If the unit you desire is not available, enter the desired unit nomenclature manually into the **Unit** field. Nomenclature is limited to 6 characters or less in length. After defining a unit in this fashion, the Scaling options will be refreshed to **Factor and Offset** method if changed previously. Select desired **Scaling method** if desired.
2. In the **Scaling** options of the *Variable settings* window in *GI.bench*, you may define **Factor** and **Offset** if specified by your sensor. Keep in mind, the values defined in **Factor** and **Offset** will dynamically influence the values for **Minimum** and **Maximum** defined within the **Value Handling** options of the *Variable settings* window.
3. In the **Scaling** options of the *Variable settings* window in *GI.bench*, you may enter a transducer's (sensor's) calibration data from a respective calibration certificate or data sheet (e.g., refer to Fig. 11-5, page 216) using **2 Point calculator** as the **Scaling Method**.

You may define scaling in both of the positive and negative directions, however, you can alternatively define scaling in just one direction. To do this, enter "0" for **Input [A]** and **Output [B]** at **Point 1**, where *A* and *B* represent the base voltage unit (e.g. V) and desired unit (e.g. N), respectively. Please note, changes made within the **Scaling** menu will also influence the values for **Minimum** and **Maximum** defined within the **Value Handling** options in *Variable Settings*.

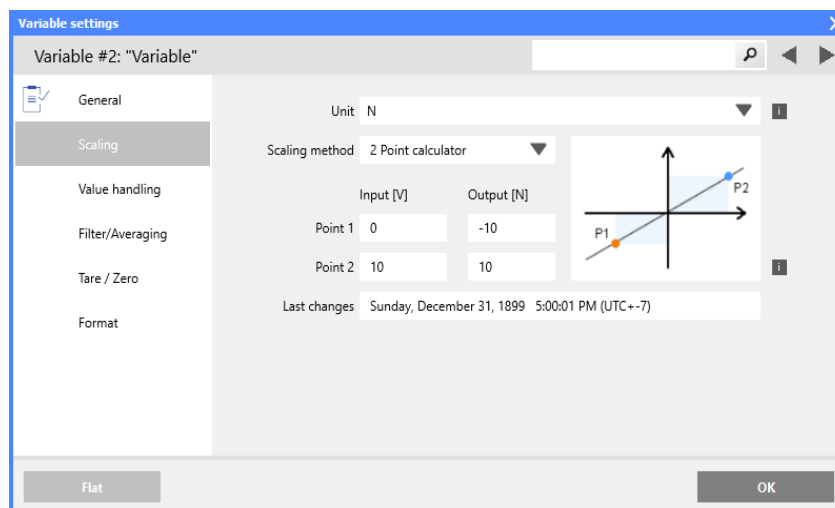

Fig. 11-5 Scaling options for voltage using 2 Point calculator

11.3.2

Scaling with Strain Gage Calculator

1. In the **Scaling** options of the *Variable settings* window, define the **Scaling method** as **Strain Gage calculator**. This will allow you to define the **Bridge Polarity**, **k Factor** and **Bridge Factor (B)** for your bridge sensor.
2. Enter the *gage factor (k Factor)* of your strain gage in the provided field.
The *gage factor* is a measure of the sensitivity of the strain gage and is stated on each strain gage sensor. It is usually between 1.8 and 2.2. Fig. 11-6 shows scaling with $k = 2$.
3. If you are using more than one active strain gage in your bridge circuit you may need to define the **Bridge Factor (B)** in the provided field. Additional details available below.
4. After clicking **OK** with *Strain Gage calculator* as the scaling method, the unit for the variable is automatically changed to **$\mu\text{m/m}$** .

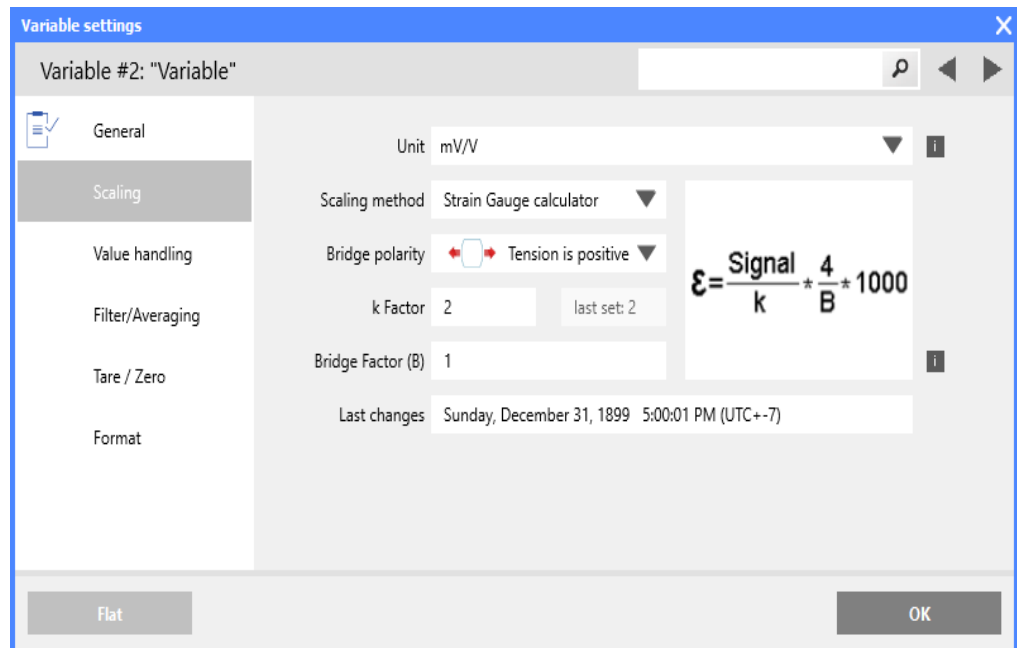

Fig. 11-6 Strain Gage calculator for scaling bridge inputs

The number of active arms in a strain gage (Wheatstone bridge) is known as the *bridge factor*. If a bridge factor is known, use that value. Otherwise, as a simple guide when selecting bridge factors, the following rules *may* apply when the strain gages are configured in a particular way:

- When using 1/4 bridge completion the bridge factor should be set to 1
- When using 1/2 bridge completion the bridge factor should be set to 2
- When using full bridge completion the bridge factor should be set to 4

Bridge factor depends on the orientation of the strain gage on the measurement object and, where applicable, also depends on the Poisson's ratio for the materials used. E.g., if strain gages are mounted in a transverse configuration for temperature compensation, then different, more complex rules likely apply.

We recommend, due to the nature of the small changes in voltage that are associated with strain gage measurements, all changes to the amplifier gain or the excitation voltage should be followed by a calibration.

11.4

Available Units in GI.bench

The following is a list of the physical quantities and associated units available in *GI.bench*. The units for any measurement can be changed and scaled freely in *GI.bench*, i.e. any custom unit with a digit length of 6 or less characters is valid. Simply type the desired custom designation in the **Unit** field under the **Scaling** category in the *Variable settings* window in *GI.bench*. The **Factor** and **Offset** for each unit is listed below in the same order.

When creating a custom unit, ensure that the proper **Factor** and **Offset** are used. Alternatively, **2 Point calculator** is available as a **Scaling method**. The units listed below can be scaled this way if selected where *Input [...]* is the base unit and *Output [...]* is the custom unit. Adjust scaling as needed for **Point 1** and **Point 2**.

For each physical quantity below, the unit(s) in bold correspond to a **Factor** of **1** and **Offset** of **0**, i.e. *base units*. All other units within the same physical quantity (i.e., units not in bold) use a combination of factor and offset to scale the base unit as needed.

Physical Quantity	Default Units and Scaling Available in <i>GI.bench</i>
Acceleration	m/s²
Factor	1
Offset	0
Angle	deg, rad
Factor	1, 1.74532925199433x10⁻²
Offset	0, 0
Bridge	V/V, mV/V, μV/V
Factor	1, 1000, 1x10⁶
Offset	0, 0, 0
Charge	C, pC, nC, μC, mC
Factor	1, 1x10¹², 1x10⁹, 1x10⁶, 1000
Offset	0, 0, 0, 0, 0
Counter	times
Factor	1
Offset	0
Current	A, μA, mA, kA
Factor	1, 1x10⁶, 1000, 0.001
Offset	0, 0, 0, 0
Distance	m, μm, mm, cm, dm, km, miles
Factor	1, 1x10⁶, 1000, 100, 10, 0.001, 6.21371x10⁻⁶
Offset	0, 0, 0, 0, 0, 0

Energy (Work)	Nm, kNm	
Factor		1, 0.001
Offset		0, 0
Force	N, mN, kN	
Factor		1, 1000, 0.001
Offset		0, 0, 0
Frequency	Hz, mHz, kHz, RPM	
Factor		1, 1000, 0.001, 60,
Offset		0, 0, 0, 0,
Mass	g, µg, mg, kg, t	
Factor		1, 1x10⁶, 1000, 0.001, 1x10⁻⁶
Offset		0, 0, 0, 0, 0
Percent	%	
Factor		100
Offset		0
Pressure	bar, mbar,	
Factor		1, 1000
Offset		0, 0
Resistance	Ohm, mOhm, kOhm	
Factor		1, 1000, 0.001
Offset		0, 0, 0
Speed	m/s, km/h (3.6), mph	
Factor		1, 3.6, 2.2369356
Offset		0, 0, 0
Strain	m/m, mm/m, µm/m, Stra, mStra, µStra	
Factor		1, 1000, 1x10⁶, 1, 1000, 1x10⁶
Offset		0, 0, 0, 0, 0, 0
Time	s, ms, µs, ns, min, h, d	
Factor		1, 1000, 1x10⁶, 1x10¹², 1.66666666666667x10⁻², 2.77777777777778 x10⁻⁴, 1.15740740740741x10⁻⁵
Offset		0, 0, 0, 0, 0, 0
Temperature	°C, °K, °F, °RNK, °R	
Factor		1, 1, 1.8, 1.8, 0.8
Offset		0, 273.15, 32, 491.67, 0
Voltage	V, µV, mV, kV	
Factor		1, 1x10⁶, 1000, 0.001
Offset		0, 0, 0, 0

11.5

Current Measurements with External Shunt

Current measurements are performed by measuring the voltage drop across a resistance of known size (i.e., shunt resistance). All Q.series XL modules that are suitable for direct current measurement possess an internal 50Ω resistor with which you can measure currents up to 25 mA (the maximum shunt power dissipation is limited to 0.25W) unless stated otherwise in this manual.

For current measurements higher than 25mA, configure the channel for voltage measurement and use an external shunt resistance terminal. The external shunt resistance terminal can be obtained under the designation *Q.bloxx Terminal SR* from Gantner Instruments or your domestic Gantner Instruments Sales and Service location

- ➔ The power dissipation of the current measured must be lower than the permissible power dissipation of the external shunt. In addition, the voltages produced on the resistance must not exceed the permissible input voltage on the analog input of the Q.series XL module.

! **IMPORTANT**

If using an external shunt, you must configure the analog input as a voltage measurement and divide the measured voltage by R_{ext} (external shunt resistance).

! **Tip**

The error of a current measurement with use of an external shunt depends on the accuracy of the resistor used.

11.6

Measurements with Thermocouples

Thermocouples consist of two thermoelectric wires made of dissimilar materials (e.g. platinum & platinum/rhodium) joined together at one end, usually by welding. If the temperature at the welded juncture, or contact point, differs from the other two ends of the thermoelectric wires then a thermoelectric voltage is produced at the contact point. This thermoelectric voltage is essentially proportional to the temperature difference between the contact point and the ends of the thermoelectric wires.

Since thermocouples can only measure the difference between the temperatures at the contact point and the module's input terminal, in order to ensure accurate measurement, either the terminal temperature must be known or the "transition" from thermocouple wire to copper wire must occur at a known temperature. The first case is known as internal cold junction compensation (TC_{int}) and the second case as external cold junction compensation, TC_{ext} .

To acquire temperature with *internal* cold junction compensation, an additional temperature probe is necessary to measure the reference temperature. For Q.series XL modules, it is necessary to have a cold junction compensation terminal block (CJC) with an integrated Pt1000 temperature probe to ensure accurate thermocouple measurement. With such terminal blocks, the temperature at the transition point is determined and the voltage produced by the thermocouple is corrected according to the type of thermocouple wire used.

To acquire temperature with *external* cold junction compensation, a second thermocouple of the same type is necessary. This second thermocouple is connected in series with the primary thermocouple. Polarities are chosen such that the thermoelectric voltages subtract from one another. The second thermocouple is usually located at a fixed reference temperature (e.g. 0°C). With such a setup, a Q.series XL module can calculate the temperature at the measuring point based on a linearization curve. This would require that the user define which temperature measurement in the Q.series XL module is being used as a reference cold point temperature.

12

Sales & Service Information

Contact information for your domestic Gantner Instruments Sales and Service location as well as our corporate headquarters, Gantner Instruments, can be found on our website at: <https://www.gantner-instruments.com>. You can select your region using the button at the top-right corner of the Gantner website.

You can find additional technical information in the Technical Information section of the Gantner Instruments Wiki at:

<https://dev.gantner-instruments.com/dokuwiki>.

Please use the following login information to gain access.

Username: *support*

Password: *gins*

(Note: Not all sections of the dokuwiki are open to the public).

Austria

Gantner Instruments

Montafonerstraße 4

6780 Schruns

Tel.: +43 (0) 5556 77463-0

Fax: +43 (0) 5556 77463-300

E-Mail: office@gantner-instruments.com

Web: www.gantner-instruments.com

Gantner Instruments GmbH

Montafonerstrasse 4
6780 Schruns
Austria

T +43 5556 77 463-0
info@gantner-instruments.com

www.gantner-instruments.com

Austria | Germany | France | Sweden | India | USA | China | Singapore



Test and Measurement Technology.
Designed for You.



Europe

