

Q.series XE MANUAL

The screenshot displays the software interface for configuring variables. At the top, there are icons for Read, Write, Import, and Export. Below this is a table listing various variables and their configurations.

	Name	Type	Type info	Range
i#1	Adapter 1			
i#1 (DataBuffer 1)	Adapter 3			
brxxx A101	User			
V1	Tweez_Variable 1a 1	Analog input		
V2	Variable 2a 2	Analog input		
V3	Variable	Setpoint		
brxxx A104 TCK	User			
V1	Variable 1	Analog input		
V2	Variable 2	Analog input		
V3	Variable 3	Analog input		
V4	Variable 4	Analog input		
V5	Variable 5	Analog input		
V6	Variable 6	Analog input		
V7	Variable 7	Analog input		
V8	Variable 8	Analog input		
brxxx A111 custom	User			
V1	Variable 1c	Analog input		
V2	Variable 2c	Analog input		
V3	Variable 3c	Analog input		
V4	Variable 4c	Analog input		
Q.raxx A108	User			
Variable 1		Analog input		
Adapter 4		Analog input		

The 'Variable settings' panel for 'Variable #5...' is also visible, showing configuration options such as Name (Variable 2), Type (Analog input), Sensor (Bridge), Analog input type (Bridge, Resistive Full 4-Wire), Terminal (Connector2.AIn1), and Scaling (Unit: mV/V, Scaling method, Factor: 1000, Offset: 0). A connection diagram and the formula $Y = \text{Factor} \times X + \text{Offset}$ are also shown.



© 2019 Gantner Instruments

Operating instructions, manuals and software are protected by copyright. Copying, duplicating, translating, conversion into any electronic medium or into machine readable form, completely or partially, is only permissible with the expressed consent of Gantner Instruments. An exception is the making of a copy of software for one's own use for backup purposes, where this is technically possible and recommended by us. Infringements will be pursued in law and will be subject to compensation claims.

All trademarks and brand names used in this document only indicate the respective product or the proprietor of the trademark or brand name. The naming of products which are not from Gantner Instruments is made exclusively for informative purposes. Gantner Instruments makes no claims on trademarks or brand names other than its own.

Table of Contents

1	Safety Information	9
1.1	Intended Use.....	9
1.2	Checking for Damage in Transit.....	9
1.3	Personnel	10
1.4	Special Risks	10
1.5	Installation Environment.....	10
1.6	Modifications.....	11
1.7	Servicing and Cleaning	11
1.8	Disposal.....	11
1.9	General Hazards due to Improper Operation	12
2	Warnings and Labels.....	13
2.1	Warnings	13
2.2	Labels on Modules	13
2.3	Labels in this Manual.....	14
3	Introduction	15
3.1	Documentation for Q.series XE.....	16
3.2	About this Manual.....	16
3.3	System Description	17
4	Measuring with EtherCAT.....	19
4.1	Method of Operation	19
4.2	The EtherCAT Master	19
4.3	Synchronization of EtherCAT Bus Devices	20
4.4	Connecting Q.series XE Modules	20
4.5	Configuring Q.series XE Modules	20
4.6	Support for Fast Data Transmission (XFC)	21
5	System Assembly & Setup.....	23
5.1	Mounting Q.bloxx XE Systems	23
5.2	The Q.series X Socket	24
5.2.1	Configure Operating Mode.....	24
5.2.2	Mounting and Removing Q.bloxx X Sockets.....	25
5.3	Connecting the Power Supply.....	27
5.3.1	Configuring Module Addresses via DIP Switch (Option).....	28
5.3.2	Activating Terminating Resistances in Modules.....	29
5.4	Inserting and Removing Modules from Sockets	30

5.5	Q.series XE Modules and Connection Detail	32
5.5.1	Q.series XE BC Communication Interfaces.....	32
5.5.2	Connecting the Q.series XE BC via EtherCAT Interface.....	32
5.5.3	Manually Installing the USB Interface Driver on a PC.....	32
5.6	Q.series XE LED Flash Sequence Codes.....	35
5.6.1	LED Codes for Q.series XE BC (Bus Coupler).....	35
5.6.2	LED Codes for Q.series XE Measurement Modules.....	35
5.6.3	Overview of Q.series XE Measurement Modules.....	38
5.7	Q.series XE A101: Connecting Sensors and I/O	40
5.7.1	Voltage	40
5.7.2	Current	41
5.7.3	Potentiometer	41
5.7.4	Resistance, Pt100, Pt1000	42
5.7.5	Thermocouple	42
5.7.6	Full and Half-bridge Transducer.....	43
5.7.7	Quarter-bridge Strain Gage	43
5.7.8	IEPE/ICP®	44
5.7.9	Digital Input and Output.....	44
5.8	Q.series XE A102: Connecting Sensors and I/O	45
5.8.1	Voltage	45
5.8.2	Current	46
5.8.3	Full and Half-bridge Transducer.....	46
5.8.4	Quarter-bridge Strain Gage	47
5.8.5	IEPE/ICP®	47
5.8.6	Analog Output.....	48
5.8.7	Digital Input and Output.....	48
5.9	Q.series XE A103: Connecting Sensors and I/O	49
5.9.1	Voltage	49
5.9.2	Current	50
5.9.3	Digital Input and Output.....	50
5.10	Q.series XE A104 TCK: Connecting sensors	51
5.10.1	Voltage	51
5.10.2	Thermocouple	52
5.11	Q.series XE A105: Connecting Sensors	53
5.11.1	Resistance, Pt100, Pt1000	53
5.12	Q.series XE A106: Connecting Sensors and I/O	55
5.12.1	Full and Half-bridge Transducer	55
5.12.2	Quarter-bridge Strain Gage	56
5.12.3	Inductive Full and Half-bridge Transducer.....	57
5.12.4	LVDT, RVDT.....	57
5.12.5	Analog Output.....	58
5.12.6	Digital Input and Output.....	58

5.13	Q.series XE A107: Connecting Sensors	59
5.13.1	Voltage.....	59
5.13.2	Current	60
5.13.3	Potentiometer	60
5.13.4	Resistance, Pt100, Pt1000.....	60
5.13.5	Thermocouple	61
5.13.6	Full-bridge Transducer.....	62
5.13.7	Half and Quarter-bridge Strain gage	62
5.14	Q.series XE A108: Connecting Sensors and I/O.....	64
5.14.1	Voltage.....	64
5.14.2	Current	65
5.14.3	Digital Input and Output	65
5.15	Q.series XE A109: Connecting I/O and Outputs	66
5.15.1	Digital Input and Output, Terminal 1 Only.....	66
5.15.2	Analog Output, Terminal 2 Only	67
5.16	Q.series XE A111 BNC: Connect Sensors.....	68
5.16.1	Voltage.....	68
5.16.2	IEPE/ICP®	69
5.17	Q.series XE A116: Connecting Sensors	70
5.17.1	Full and Half-bridge Transducer	73
5.17.2	Quarter-bridge Strain Gage.....	75
5.17.3	Activating the Shunt Resistance.....	77
5.18	Q.series XE A121: Connecting Sensors	80
5.18.1	Voltage.....	80
5.18.2	Current	81
5.18.3	Potentiometer	81
5.18.4	Resistance, Pt100, Pt1000.....	81
5.18.5	Full and Half-bridge Transducer	82
5.18.6	IEPE/ICP®	82
5.19	Q.series XE A123: Connecting Sensors	83
5.19.1	Voltage.....	84
5.20	Q.series XE A124: Connecting Sensors	85
5.20.1	Voltage.....	86
5.20.2	Thermocouple	86
5.21	Q.series XE A127: Connecting Sensors	87
5.21.1	Voltage.....	88
5.21.2	Current	88
5.22	Q.series XE A128: Connecting sensors.....	90
5.22.1	Voltage.....	91
5.23	Q.series XE A141 BNC: Connect Sensors.....	92
5.23.1	Piezoelectric, Charge	92

5.24	Q.series XE A146: Connecting Sensors	93
5.24.1	Quarter-bridge Strain Gage	96
5.25	Q.series XE D101: Connecting I/O	99
5.25.1	Digital Input and Output	99
5.26	Q.series XE D104: Connecting Digital Inputs	101
5.26.1	Digital Input	101
5.27	Q.series XE D105: Connecting Digital Outputs	102
5.27.1	Digital Output	102
5.28	Q.series XE D107: Connecting Digital Inputs	103
5.28.1	Digital Input	103
6	System Configuration	107
6.1	EtherCAT Slave Configuration	107
6.1.1	Dynamic PDO Configuration	107
6.1.2	Static PDO Configuration	108
6.1.3	Configuration Check During Init	109
6.2	Configuration via GI.bench	110
6.3	Installing GI.bench	111
6.4	Communication & Configuring Parameters	112
6.5	Configuring Analog Inputs in GI.bench	115
6.5.1	Sensor Parameters in GI.bench	115
6.5.2	Carrier Frequency Synchronization (Q.series XE A106) ...	117
6.5.3	Zeroing and Taring Sensor Measurements	118
6.6	Defining Digital Inputs & Outputs in GI.bench	121
6.7	Configuring Analog Outputs in GI.bench	123
6.8	Defining Arithmetic Channels in GI.bench	125
6.9	Configuring Alarm Monitoring in GI.bench	127
6.10	Setting Oversampling (XFC)	128
6.11	Module Firmware Updates via ICP100	129
6.12	Communication & Configuration with TwinCAT	130
6.12.1	Module Configuration Files for EtherCAT Masters	130
6.12.2	Defining an Interface	131
6.12.3	Linking Q.series XE Modules in TwinCAT	132
6.12.4	Configuring Examples in TwinCAT	136
6.12.5	Saving Configuration Changes in TwinCAT	138
6.12.6	Configuring the Distributed Clock (DC) in TwinCAT	140
6.13	Q.series XE Module SDO Information	141

7	Appendix	151
7.1	Connecting Transducers with Sensing Leads	151
7.2	Sensor Scaling in GI.bench.....	152
7.2.1	Scaling Voltage Signals and Strain Gage Bridges	153
7.2.2	Scaling with Strain Gage Calculator	154
7.2.3	Available Units GI.bench	155
7.3	Current Measurements with External Shunt.....	158
7.4	Measurements with Thermocouples	159
7.5	List of Enumerations (ENUMs).....	160
7.5.1	General	160
7.5.2	Filter	161
7.5.3	Null Tare	164
7.5.4	Status.....	164
7.5.5	Scaling	165
7.5.6	Digital Input	166
7.5.7	Digital Output	167
7.5.8	Analog Output	168
8	Sales & Service Information	173

1

Safety Information

Before performing any installation, operation or maintenance processes, it is essential to carefully read and understand the appropriate warning and safety information provided in this manual. Please perform these tasks as intended (i.e., as directed in this manual and the technical data sheets for the relevant modules or devices). Failure to do so may result in damage to the connected modules or devices. If you require any technical support, please contact Gantner Instruments or your domestic Gantner Instruments Sales and Service location.

1.1

Intended Use

Q.series XE products are intended for use in test engineering (experimental and industrial) as well as process monitoring (production and assembly) applications. Transducers (sensors) can be connected to Q.series XE products for the control, acquisition, manipulation, and storage of physical quantities such as voltage, current, resistance, temperature, force, displacement, torque, mass, strain, and pressure (data). Q.series XE products, especially the measurement modules, are intended to be used exclusively for these purposes. Any application that extends beyond the scope as mentioned above does not fall within the intended use of Q.series XE products.

To ensure safe operation, carefully select the appropriate Q.series XE product(s) for each application (i.e., select modules for purposes that align with their respective intended use). Additional details regarding each Q.series XE product and their intended uses are available in this manual as well as in each Q.series XE product's respective technical data sheet.

Always carefully follow all necessary legal and safety guidelines pertinent to your application. This applies especially to any application in which the Q.series XE A121, A123, A124, A127, or A128 modules are utilized as they for voltage inputs of up to $1200V_{DC}$.

1.2

Checking for Damage in Transit

Upon receipt of goods, visually confirm that the packaging and all included items are intact and not damaged. Please also confirm the completeness of the order shipment (i.e., all expected accessory parts, documentation, and auxiliary aids are included). If you suspect the packaging or any included items have been damaged in transit, do not put them into operation. Contact Gantner Instruments or your domestic Gantner Instruments Sales and Service location immediately for further instruction.

1.3

Personnel

The installation, operation, and maintenance of Q.series XE products should only be performed by appropriately trained personnel. Such individuals should possess the necessary professional education, experience within their respective field and be aware of all applicable national occupational safety regulations and engineering practices.

Personnel assigned to the operation of Q.series XE products must be able to reliably assess the results of their work, be familiar with the contents of this manual as well as be aware of all support options available to them. As always, electrical connections should only be performed by specialist personnel with sufficient training and certifications.

In particular, please pay attention to the following while referencing this manual:

- national installation regulations
- generally accepted engineering rules and methods
- information regarding transport, installation, operation, maintenance, repair and disposal of Q.series XE products
- the characteristic functionality, parameter limits and intended operating and ambient conditions of Q.series XE products.

1.4

Special Risks

The A121, A123, A124, A127, and A128 modules are specially designed for high voltage measurements. Up to 1200V can be applied to these modules. Touching the sensor connection contacts or any exposed wires in the connected sensor cables can result in serious bodily injury or even death. Therefore, it is crucial that only qualified personnel have access to these modules and that they ensure the modules have been de-energized via a power switch or similar device before maintenance is performed.

1.5

Installation Environment

Please note that the permissible ambient conditions for each Q.series XE product specified in this manual or in their respective technical data sheet. If you have questions regarding any Gantner product, please contact Gantner Instruments or your domestic Gantner Instruments Sales and Service location for information.

If you suspect the ambient conditions of an installation site would require additional protection for a Q.series XE system, consider installing the Q.series XE system in a waterproof enclosure.

1.6

Modifications

Gantner Instruments does not permit the modification or disassembly of Q.series XE products, except as expressly stated within this manual. Protective housings of Q.series XE modules or devices may only be removed for calibration or technical service purposes by Gantner Instruments. If you have questions regarding permissible modifications for Q.series XE products, please contact Gantner Instruments or your local Gantner Instruments Sales and Service location for more information.

1.7

Servicing and Cleaning

Q.series XE products are designed to be maintenance-free. However, if it is required, cleaning should only be performed when Q.series XE modules and devices are in a de-energized state. Please follow the instructions below if you would like to clean your Q.series XE modules or devices:

- Power down and de-energize all Q.series XE modules and devices
- Remove all electrical connections to Q.series XE modules and devices before cleaning
- Clean the housing of Q.series XE modules and devices with a soft, slightly damp cloth (e.g. microfiber). Do not use solvents of any kind when cleaning as they can damage the housing
- When cleaning with a slightly damp cloth, ensure that no liquid gets into the housing or any electrical connections

Never attempt to repair a Q.series XE module or device if you detect defects, faults or damage of any kind. If you detect any of these, contact Gantner Instruments or your domestic Gantner Instruments Sales and Service location for assistance.

1.8



Disposal

For the disposal of old or no longer functional Q.series XE products, please follow all applicable national and local environmental protection and raw material recovery regulations for the disposal of electronic devices and components. Electronic components of any kind should never be disposed of with regular waste. The aluminum housing of Q.series XE products is recyclable.

Gantner Instruments recommends the original packaging of each Q.series XE product is kept until the end of their warranty period for proper storage and shipping of additional or faulty Q.series XE products, respectively.

1.9

General Hazards due to Improper Operation

All Q.series XE products are designed for reliability, stability, and safe operation. However, improper operation of Q.series XE products by untrained personnel may introduce hazards that could otherwise be avoided.

The installation, operation, and maintenance of Q.series XE products should only be performed by appropriately trained personnel who are familiar with the contents of this manual and aware of all the support options available to them.

Should you have any questions regarding recommended methods for installation, operation, and maintenance of Q.series XE products, contact Gantner Instruments or your domestic Gantner Instruments Sales and Service location for information.

2

Warnings and Labels

2.1

Warnings

To prevent personal injury and damage to property, follow the warning and safety information given in this operating manual.



Indicates a directly threatening hazard. If it is not prevented, the consequence will be fatal or serious injuries.



Indicates a possibly hazardous situation. If it is not prevented, the consequence may be fatal or serious injuries.



Indicates a possibly hazardous situation. If it is not prevented, the consequence may be injuries of slight or medium severity.

NOTICE

Indicates a situation in which the consequence may be property damage if the information is not followed.

2.2

Labels on Modules

Symbol: 

Meaning: This is the official CE mark. With this mark, we guarantee that our products meet the requirements of the relevant EC directives.

Symbol: **CAT I, CAT II, CAT III**

Meaning: Modules with a measurement category symbol are intended for the connection of high voltage. The maximum permissible voltage of such modules is indicated by the measurement category rating it is assigned.

Symbol: 

Meaning: There may be high voltage at the terminals of this module. Connections may only be performed with the insulated terminals provided by Gantner Instruments.

2.3

Labels in this Manual

This manual utilizes the following labels and notation in addition to the warnings listed above:

IMPORTANT

Paragraphs with this label give important information relevant to the topic or product discussed in that section.

Tip

Paragraphs with this label provide tips and other particularly useful information relevant to the topic discussed in that section.

Symbol: 

Meaning: Before connecting or disconnecting, make sure that all electrical lines are de-energized.

<i>italics</i>	indicates importance or the name of an official Gantner Instruments software tool or feature
interface	indicates necessary user input: target menu items or clicks; target entry fields in interfaces
Options	indicates menu items (sequence), program interfaces (general or non-target)
>	notation that denotes a sequence of menu items (e.g., Options > Settings)
➔	indicates special features, restrictions, and recommendations to the user, i.e. Please Note

3

Introduction

Dear Customer,

Thank you for purchasing your very own Q.series X product(s) developed by Gantner Instruments. We are confident you will be pleased with your purchase of a professional quality product that enables fast, accurate and reliable data acquisition.

We at Gantner Instruments, an international and customer oriented test and measurement technology company, are always interested in knowing your experience while using our products. It is our primary focus and the main driver behind our continuous innovation. Should you discover any technical faults within our products, errors in our support documentation or if you want to provide feedback, please contact your domestic Gantner Instruments Sales and Service location or our corporate headquarters. You can find the contact information for your domestic Gantner Instruments Sales and Service location as well as our corporate headquarters on our website at <https://www.gantner-instruments.com>.

The scope of your delivery also includes this manual. Please keep this manual in a safe place for constant reference. You may download the latest version of this manual from our website. To avoid personal injury and property damage, please review and follow the Safety Information & Warnings and Labels sections in this manual. Should you ever get stuck despite studying this manual, please contact our corporate headquarters or your domestic Gantner Instruments Sales and Service location for information.

You can also find additional technical information in the Technical Information section of the Gantner Instruments Wiki at:

<https://dev.gantner-instruments.com/dokuwiki>.

Please use the following login information to gain access.

Username: *support* Password: *gins*

(Note: Not all sections of the wiki are open to the public).

Austria

Gantner Instruments

Montafonerstraße 4

6780 Schruns

Tel.: +43 (0) 5556 77463-0

Fax: +43 (0) 5556 77463-300

E-Mail: office@gantner-instruments.com

Web: www.gantner-instruments.com

3.1 Documentation for Q.series XE

Documentation for Q.series XE includes this manual which covers the Q.series XE modules and the Q.series XE BC (bus coupler), as well as a data sheet for each Q.series XE product.

You can download this manual and each data sheet in PDF format from our website www.gantner-instruments.com.

3.2 About this Manual

This manual describes the installation, operation, and configuration of the measurement modules Q.series XE A101, A102, A103, A104, A105, A106, A107, A108, A109, A111, A116, A121, A123, A124, A127, A128, A141, A146, F108, D101, D104, D105 and D107 using the Q.series XE BC (bus coupler) and the program *GI.bench*. Also included is an introduction to setup and method of operation with an EtherCAT master, e.g., *TwinCAT* from Beckhoff. The modules differentiate from each other via their quantities of analog and/or digital inputs and outputs, maximum possible sample rates, and admissible input voltages.

This manual is divided into several chapters:

- Safety information in Chapter 1, page 9.
- A description of the labels and symbols used on the modules and in this documentation can be found in Chapter 2 from page 13 onwards.
- You will find a description of the system and the main combination and expansion options in the next section.
- Chapter 4 from page 19 contains an introduction to the method of operation of EtherCAT.
- Description of the connection variants and pin assignments of module inputs and outputs can be found in Chapter 5, *System Assembly & Setup*, page 23.
- An explanation of the module configuration using *GI.bench* and an introduction to *TwinCAT* can be found in Chapter 6, *System Configuration* from page 107.
- In Chapter 7, *Appendix* on page 151 you will find explanations of using sensors (sensing leads, scaling, current, and temperature measurements).

3.3

System Description

Q.series XE measurement modules are designed for industrial and experimental testing purposes. Q.series XE products are exceptionally well suited for performing highly synchronized, multi-channel measurements of electrical, mechanical and thermal signals on engine and component test rigs as well as long-term process monitoring applications in EtherCAT networks. Individual channels on each module can change their operating mode to measure either voltages, thermocouples, resistances, or sensors. Depending on the operating mode, other options such as circuit configurations, selectable measurement ranges, filters and more are available. The Q.series XE A121, A123, A124, A127, and A128 modules are designed specifically for high-voltage.



Voltage inputs of up to 1200V may be connected to Q.series XE A121, A123, A124, A127 and A128 modules.



Before performing service to or with cables or the modules, ensure to *Lockout/Tagout* any connected power supplies.

Individual Q.series XE modules are combined together to form a custom data acquisition system as needed. You can connect up to 10 modules as independent EtherCAT slaves per bus coupler to an EtherCAT master. For all measurement modules, the power supply, bus interface, and I/O (analog and digital) are all electrically isolated from each other.

Alternatives

Standard Q.series and Q.series XL measurement modules can be used in an EtherCAT network if connected to the Test Controllers Q.station or Q.station X, respectively. These Test Controllers have EtherCAT interfaces and can bundle data from their connected modules. To an EtherCAT master, these Test Controllers appear as bus devices with various inputs and outputs. In addition, these Test Controllers can output data over Ethernet, carry out event-controlled acquisition, send with FTP, etc. It is possible to satisfy two or more applications at the same time without EtherCAT functionality being restricted. You can connect up to 64 modules per controller and you can integrate several controllers within an EtherCAT network.

4

Measuring with EtherCAT

EtherCAT (Ethernet for Control Automation Technology) is a field bus based on Ethernet and has been standardized since 2007 in IEC 61158. The EtherCAT field bus is suitable for real-time requirements. The advantages include:

- fast data transfer with short cycle times ($\leq 100\mu\text{s}$),
- low jitter ($\leq 1\mu\text{s}$) which facilitates very good synchronization,
- low hardware costs,
- various methods of wiring using either line, tree, ring, or star topologies, facilitating line redundancy.

4.1

Method of Operation

An EtherCAT network consists of a master and generally several slave devices. Here, the master can be a commercially available PC with an EtherCAT compatible network card; the slave devices usually have an EtherCAT slave controller integrated in hardware as ASIC or FPGA.

The master sends an EtherCAT frame (data block, also known as a telegram). The EtherCAT telegrams are embedded in a normal Ethernet data block (packet). All bus devices pass on this data block within a defined time. During this time period they extract the data intended for them from the EtherCAT frame and insert the data they have produced into the frame. The last bus device then passes the data block back to the master.

The propagation time is only determined by the defined delay time per bus device. This is the time needed to transfer three bits. Consequently, EtherCAT facilitates fixed reaction times.

4.2

The EtherCAT Master

The EtherCAT master is the only bus device that can actively send an EtherCAT frame. In this way it controls all EtherCAT bus devices and also facilitates the configuration of a system.

Various programs are on the market that facilitate the installation of an EtherCAT master on almost any hardware provided it uses a standard Ethernet Medium Access Controller (MAC). However, in practice there are restrictions depending on the program used, so we advise you to follow the manufacturer's instructions for your program.

To recognize the properties of the bus devices, i.e. the inputs and outputs, the master requires information regarding the needed data. Therefore, the master takes over the real-time transfer of the data while a configuration tool handles the module settings. The configuration tool is used to provide either the standardized slave description files (ESI, EtherCAT Slave Information) or a complete network configuration file (ENI, EtherCAT Network Information) to the master.

4.3 Synchronization of EtherCAT Bus Devices

For the exact synchronization of all bus devices, EtherCAT offers the Distributed Clock (DC) mechanism. In this case each bus device has a clock which is normally synchronized by the master. Here, the simultaneity is better than 1 μ s. This means that the outputs, for example, which are set by various I/O modules, or the data from inputs have a maximum “offset” of 1 μ s. Make sure that the setting **DC (Distributed Clock)** is active in the master for the synchronization.

4.4 Connecting Q.series XE Modules

Q.series XE modules connect to a master using an EtherCAT bus coupler. For I/O components EtherCAT specifies an LVDS (Low Voltage Differential Signal) transfer, which is similar to RS-485 and which takes place in the Q.series XE modules via the ET1100 chip set from Beckhoff. Therefore, when connecting the I/O assemblies, the bus coupler Q.series XE BC is needed to convert the signals to the Ethernet standard. You can connect up to ten modules to one bus coupler. Each module has its own EtherCAT slave controller with Distributed Clock (DC).

4.5 Configuring Q.series XE Modules

As with all Q.series X products, the Q.series XE measurement modules can be configured in many ways. The individual channels of each module can change operating modes to measure either voltages, thermocouples, resistances, or sensors. Depending on the configured operating mode, options such as circuit configurations, selectable measurement ranges, filters, and more are available. For most EtherCAT slaves, settings are principally modified using so-called SDOs (Service Data Objects). However, some Q.series XE settings are not fully supported by all EtherCAT configuration tools. Some configurations can take place using a slave description file (ESI), however, an additional file is needed for every possible configuration. For this reason, Q.series XE modules only contain a general ESI file; detailed configurations are carried out using both SDOs and CoE (not supported by all masters).

Q.series XE modules support several protocols for configuration:

1. CoE: CAN application protocol over EtherCAT
With this protocol, the communication mechanisms of CAN are available. Configuration is carried out with SDOs (Service Data Objects) and the process data are arranged with PDO (Process Data Objects) mapping.
2. FoE: File access over EtherCAT
Many file types can be transferred with this protocol, e.g., configuration files or firmware updates can be sent to the modules using FoE.

Therefore, there are various ways to configure your system:

1. Configure all module settings using Gantner's graphically guided configuration software GI.bench and then transfer the parametrization file over the USB interface of the bus coupler. The configuration is read by the master so that all configured settings are recognized.
2. Configure all module settings using Gantner's graphically guided configuration software GI.bench and then transfer the parametrization file via the EtherCAT master using FoE. The configuration is read by the master so that all configured settings are recognized.
3. The Q.series XE modules offer a simplified ESI file. With this the master can read the configuration of the modules and put them into operation with a default configuration. You can then carry out further configurations with the EtherCAT master via CoE and SDOs, provided this is supported by your master.

4.6

Support for Fast Data Transmission (XFC)

In an EtherCAT network, measurements can be transferred up to a maximum of 10,000 times per second (Hz). To achieve higher data rates for individual bus devices, the Q.series XE modules support XFC Technology (eXtreme Fast Control Technology) from Beckhoff. With XFC Technology, a slave does not transfer only one measurement per EtherCAT telegram, but rather several measurements (oversampling). Here, measurements themselves are acquired synchronously and are "collected" before they are output. If a telegram cycle time is 200µs and 10 measurements per telegram are transferred, then you get a time-base resolution of 20µs for the measurements of this channel.

You can transfer up to 100 values of a channel in one telegram using XFC Technology. The oversampling factor here can be set for each Q.series XE module to obtain different sample rates. In total, approx. 1450 bytes per telegram are available to which measurements or values can be assigned. If required, the master can transfer another telegram to fetch values, assuming the selected cycle time permits this within the bandwidth of the EtherCAT interface (the Q.series XE modules support 100Mbit/s).

i Tip

A configuration example can be found in Section 6.10, page 128.

5

System Assembly & Setup

This chapter describes the connection and pin assignments of the Q.series XE bus coupler and measurement modules. Connection variants for measurement modules are organized by sensor type.

5.1

Mounting Q.bloxx XE Systems

For a Q.bloxx XE system, the Q.bloxx XE BC (bus coupler) and Q.bloxx X sockets (i.e., backplanes) of the Q.series XE measurement modules must each be mounted individually to DIN rail first (35mm DIN rail according to DIN EN 60715). Up to 10 sockets can be connected to a Q.bloxx XE BC. See Section 5.2.2, page 25 for more detailed instructions for mounting Q.series XE sockets.

Once the bus coupler and sockets are installed on mounting rail, the sockets can be pushed together and connected to the bus coupler to create a single backplane.

NOTICE

Q.series XE measurement modules must only be connected to or disconnected from a bus coupler while in a de-energized state.

Remove all connected power supplies from the bus coupler, or the measurement modules may be damaged in the process.

! IMPORTANT

The DIP switch terminal on the Q.series X module (CPU board), used for *RS485 interface (UART)* and *terminating resistor* as well as the DIP switch terminal on the socket, used for the *module address* and *hot-swap*, must each be configured before mounting modules to their respective sockets (Fig. 5-1 & Fig. 5-2, page 25).

- ➔ The USB to RS485 converter of the Q.series XE BC is connected only to UART 1. Therefore, the DIP switch positions 1+2 on the module CPU board should be ON. DIP switch positions 9+10 are used to activate the terminating resistor of the last module.

With the modular backplane assembled, the Q.series XE measurement modules can be connected to their respective sockets; start with the left-most socket adjacent to the bus coupler and sequentially install each module in their socket. Make sure to include a pair of *black plastic inserts* on the right hand side of each module when connecting them to their respective socket. The inserts provide guidance for the insertion of the next module in sequence (the inserts are not necessary on last module). Once the modules are inserted into their respective sockets, tighten the front-facing screws on each module.

5.2

The Q.series X Socket

The socket of a Q.series XE module is the smallest unit within the Q.series XE modular backplane. The backplane is responsible for supplying power to each module, system synchronization, system configuration, and measurement data transfer. Each Q.series XE module is electrically grounded to the mounting rail it is installed on (DIN 35mm rail according to DIN EN 60715) via the metal spring on the bottom the socket.

5.2.1

Configure Operating Mode

The operating mode of a module is configured across two sets of DIP switch terminals: one terminal is on the module's CPU board and the other terminal is on the socket.

Module addresses can be defined via the DIP switch terminal on the socket, e.g., see Fig. 5-1. On the socket, DIP switch terminal positions (or bits) 1 to 7 are used to assign module addresses in binary form. Socket DIP switch position (or bit) 8 is for activating (bit OFF) and deactivating (bit ON) the hot-swap feature.

i Tip

While configuring module addresses, it is always recommended to start with an address of "1".

To set a DIP switch bit, push it towards one of the sides labeled "ON" or "OFF" as shown in Fig. 5-1 & Fig. 5-2, page 25.

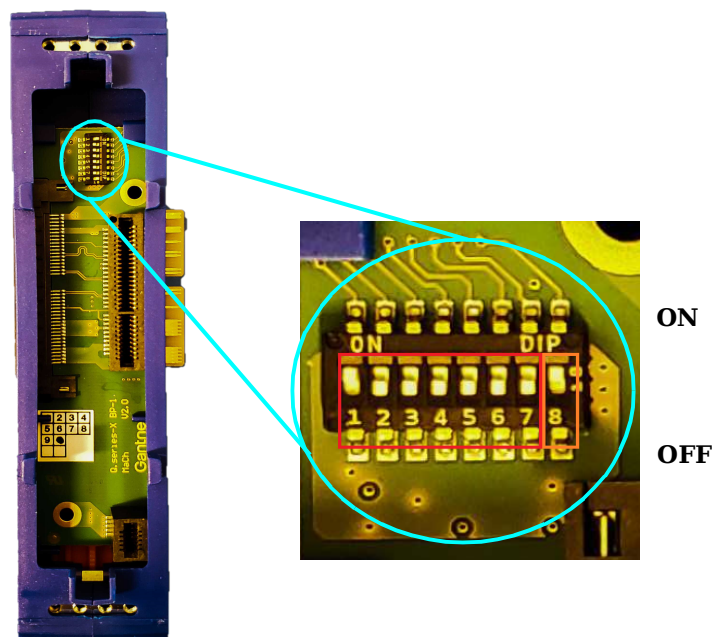

Fig. 5-1 DIP switch terminal on Q.bloxx X socket, positions (bits) 1 through 7 are used for binary addressing (red) of module and hot swap de-/activation is possible via bit 8 (orange)

The RS-485 slave interfaces (UARTs 1 through 4) and terminating resistors are set via the DIP switch terminal inside the Q.series X module, directly on the CPU board (see below in Fig. 5-2). For a Q.series XE system, only UART 1 is accessed by a Q.series XE BC.

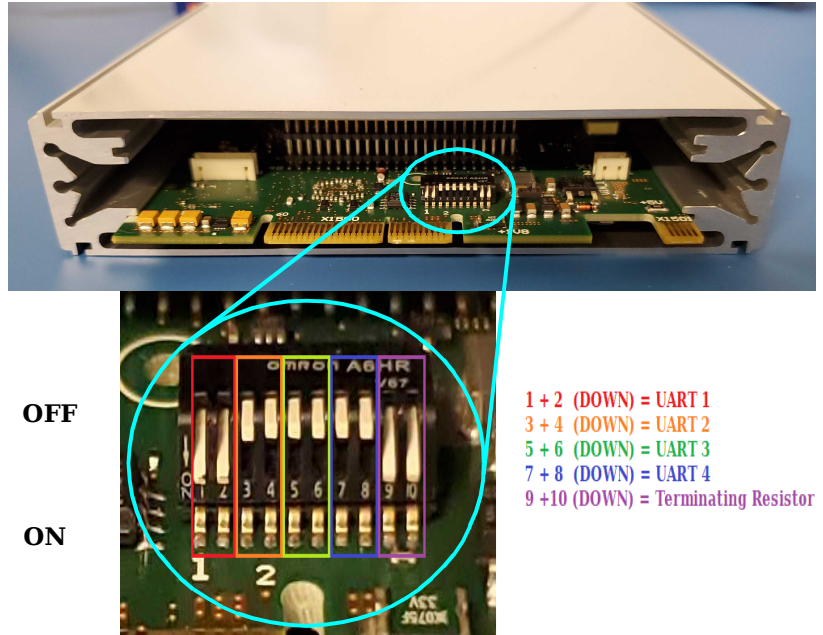

Fig. 5-2 DIP switch terminal on a Q.series X module CPU board, UARTs are assigned via position pairs 1+2, 3+4, 5+6, and 7+8 (red, orange, green, and blue). Only UART 1 can be accessed by the Q.series XE BC. Therefore, DIP switch position pairs 3+4, 5+6, and 7+8 (orange, green, and blue) should be OFF. The position pair 9+10 (purple) are used to activate the terminating resistor to end UART 1.

5.2.2

Mounting and Removing Q.bloxx X Sockets

The Q.bloxx X Standard Socket rests on the top edge of DIN rail (35 mm DIN rail according to DIN EN 60715) and can be secured in place by pushing in the orange tab on the bottom of the socket. Once a socket is secured to rail, it can be pushed to connect with other sockets to form one unit. Gantner recommends building systems using this method, from left to right, sequentially mounting and connecting sockets to each other. Press the sockets firmly together as there should be no space between the sockets (see Fig. 5-3, page 26).

- ➔ We recommend only connecting sockets to a power supply after they are properly mounted. For information on powering the Q.series XE system, please refer to Section 5.3, page 27.

To remove a socket with limited clearance, you may use a narrow screwdriver to pull down on the orange tab on the bottom of the socket. At this point, the socket is only hanging on the rail and can be removed by slightly lifting the socket off the rail. With great care, entire systems can be lifted off rail if all orange tabs are unlocked, however this method can invite unnecessary risk to both the system and personnel. It is always recommended to assemble and disassemble systems directly on mounting rail.

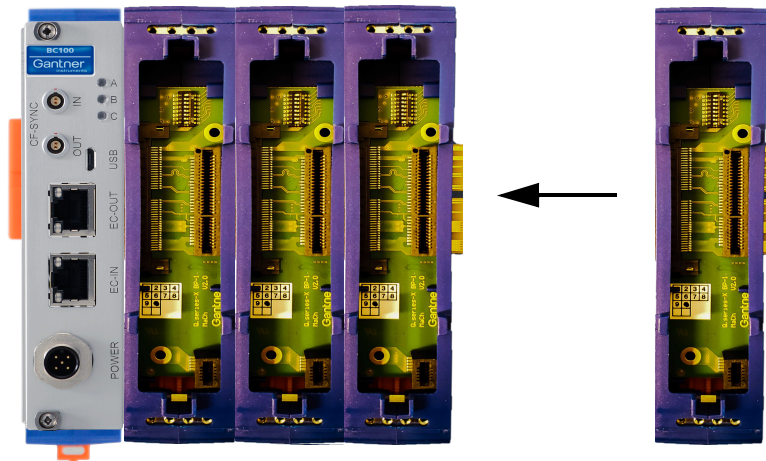
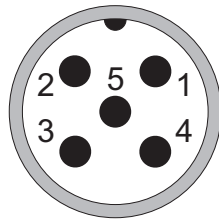

Fig. 5-3 Connecting Q.bloxx X BC and Q.bloxx X sockets together

5.3

Connecting the Power Supply

For the power supply, an unregulated direct voltage between 10V and 30V is required. The Q.series XE BC only includes the mating connector needed for an external power supply to be wired to the *POWER* interface on the bus coupler, as shown in Fig. 5-4.

POWER Interface**Pin Pin assignment**

Pin	Pin assignment
1	Supply +10 ... 30V _{DC}
2	Supply 0V (GND)
3	GND external sensor supply
4	5 ... 24V external sensor supply
5	Protective earth (PE)

Fig. 5-4 Assignments for Q.series XE BC POWER interface

Power supplied to the Q.series XE BC will be carried to all modules via the sockets (i.e., modular backplanes) directly connected to the bus coupler in series.

The Q.series XE BC itself requires approximately 2W of power to operate. Each module requires approximately 4W of power in addition to the power supplied to all connected transducers (or sensors). The power required is almost constant over the complete voltage range.

! **IMPORTANT**

When the modules are powered on, there is an increased current draw from the them until they are all in stable operation: During the start-up phase, up to 700mA (10 ms) per module is needed, depending on the supply voltage. Thereafter, you should expect approximately 500mA per module for a 10V supply or if using a 30V supply voltage, expect approximately 170mA draw per module. Make sure to only use power supplies that can *deliver the required peak power when the voltage is switched on.*

Modules have an internal self-healing (reversible) fuse to protect against overvoltages, overcurrents and incorrect polarity.

The range of acceptable wire diameters to connect terminals is 0.14mm² *minimum* to 1.5mm² *maximum*:

- Wire-ends that **do not** have plastic sleeves, acceptable range is 0.25mm² *minimum* to 1.5mm² *maximum*.
- Wire-ends that **do** have plastic sleeves, the acceptable range is 0.25mm² *minimum* to 0.5mm² *maximum*.

In total no more than 10 modules should be supplied through sockets connected together in series with the Q.series XE BC.

5.3.0.1

Transferring Configuration Data to the Socket

When a module receives configuration changes via *GI.bench*, the new configuration data is automatically transferred to the socket as well, even if the hot-swap feature is *disabled*. This process ensures that the same configuration data exists in the socket EPROM and module at all times. This allows the socket to provide the benefits of hot-swap whenever the feature is *enabled*, without having to reconfigure the module via *GI.bench*. Transfer of configuration data from socket to module only occurs when the hot-swap feature is *enabled* (see Fig. 5-1, page 24).

Replacing Sockets

1. Turn off or disconnect the power supplied to the system.
2. Remove the module from the socket to be replaced, then remove the socket from the system backplane.
3. *Enable* the hot-swap feature on the new (replacement) socket: Push DIP switch bit 8 downwards (OFF) on the new socket.
4. Mount the new socket (Section 5.1, page 23) to the system backplane.
5. With the new socket connected to the backplane, turn on or reconnect the supply voltage to power the system.
6. Plug in the (old) module into the powered (new) socket.
If hot-swap is enabled, the old module's configuration data is automatically transferred to the new socket (flashing LEDs indicate process status).
7. Wait until the configuration data download process finishes, i.e. until the LEDs are no longer flashing (either solid or off).
With hot-swap enabled, the configuration data stored in the module is overwritten by the configuration data present in the socket EPROM, if the configuration data in the socket EPROM matches the module-, submodule-, and function-types of the module inserted.

5.3.1

Configuring Module Addresses via DIP Switch (Option)

Module addresses can be set in reverse binary (left to right) form via the first seven DIP switch positions located on each socket. Setting addresses in this manner is optional; an address of "0" means the module must be assigned an address via *GI.bench*.

Modules are shipped from Gantner Instruments with a default address of "1" set via the DIP switch on the socket. It is imperative that all new modules be assigned an appropriate address, either via the socket DIP switch terminal or via *GI.bench*.

Module Address	S1	S2	S3	S4	S5	S6	S7
0	OFF ¹	OFF	OFF	OFF	OFF	OFF	OFF
1	ON ¹	OFF	OFF	OFF	OFF	OFF	OFF
2	OFF	ON	OFF	OFF	OFF	OFF	OFF
3	ON	ON	OFF	OFF	OFF	OFF	OFF
4	OFF	OFF	ON	OFF	OFF	OFF	OFF
5	ON	OFF	ON	OFF	OFF	OFF	OFF
...
10	OFF	ON	OFF	ON	OFF	OFF	OFF

¹⁾ OFF = Down; **ON** = Up; DIP switch in Fig. 5-1, page 24

➔ Socket of Q.series XE BC should *not* have an address.

5.3.2

Activating Terminating Resistances in Modules

Terminating resistances can be activated inside the last module of Localbus UART 1, i.e., via a DIP switch terminal on the module CPU board (see Fig. 5-2, page 25). Data reflections can occur on the bus line, leading to noise and other disturbances such as loss of data transmission, if not properly terminated.

Activate resistors via DIP switch terminal on module CPU board:

- Push down on DIP switch terminal positions 9 + 10 to activate the terminating resistor (see Section 5.2.1, page 24).

! IMPORTANT

Terminating resistances *must only* be activated at the last module of the Localbus UART 1. If terminating resistances are activated before the last module, the data stream (signal) is weakened and interferences, e.g., interruptions in data transmission occur for all modules located after the terminating resistances.

5.4

Inserting and Removing Modules from Sockets

Once you have mounted the sockets to rail and connected them as necessary, modules can then be plugged into their sockets starting with the module directly following the Q.series XE BC.

To do this, ensure that the module is properly oriented with respect to the socket prior to insertion, i.e., such that the module CPU board can insert into the appropriate terminal in the socket. The proper orientation has the orange tab of the socket on the bottom side of the assembled module and the blue label with module name on the top side of the assembled module. It is recommended to pull the long front-facing screws out of the way before attempting to insert the module into the socket.

! **IMPORTANT**

If more than one module is to be connected in series with the Q.series XE BC, then ensure that two long black plastic inserts are installed on the right side of each module prior to inserting them into their respective sockets. Black plastic inserts provide guidance for the following module to be inserted.

Carefully guide the module onto the black plastic inserts on the right side of the Q.series XE BC. The module should be gently guided into the socket along the black plastic inserts. Ensure that the module sits flat on the socket once fully inserted. Then tighten the long front-facing screws to lock the module in place.

To remove a module from the socket, unscrew the front-facing screws (Step 1a in Fig. 5-5, page 31) until they can be pulled out from the socket (Step 1b in Fig. 5-5, page 31), however, *do not* attempt to completely pull out the screws as they are fixed to the module. *Do not* apply a load to the long screws, especially if fully extended as they can break easily.

Once the module is no longer secured to the socket, simply pull out the module along the black plastic inserts (Step 2 in Fig. 5-5, page 31). Refer to in Fig. 5-5, page 31 for a graphical representation of the steps for removal.

i **Tip**

Be careful when removing modules as black plastic inserts can fall out from the exposed end.

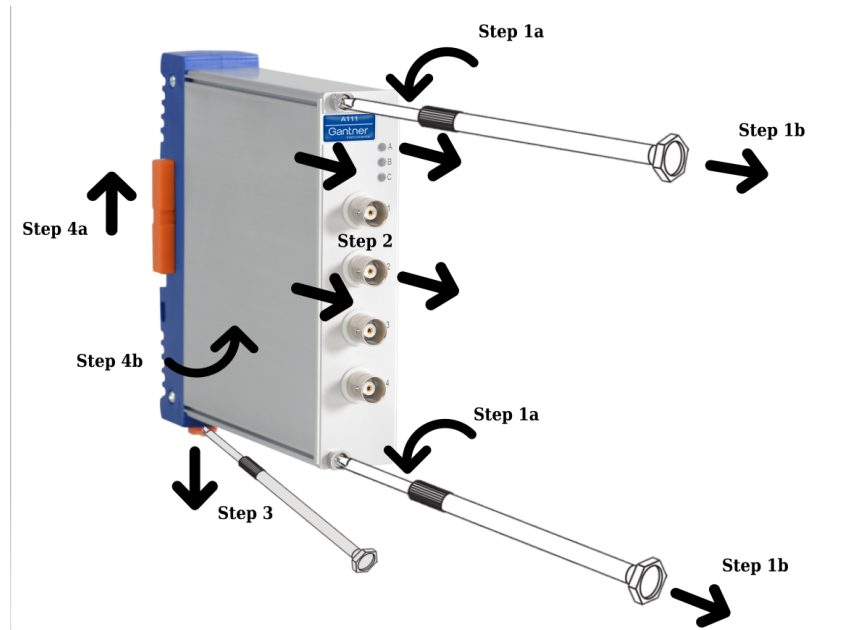

Fig. 5-5 Steps for removing Q.bloxx XE module from a socket (Steps 1+2) and removing sockets from rail (Steps 3+4)

Modules can only be removed in the reverse order that they were installed, i.e., modules must be removed from right to left and in sequence in order to remove any desired module in that series as the black plastic inserts also secures system assembly laterally.

To remove a socket with limited clearance, you may use a narrow screwdriver to pull down on the orange tab on the bottom of the socket (Step 3 in Fig. 5-5). At this point, the socket is only hanging on the rail and can be removed by slightly lifting the socket off the rail (Steps 4a + 4b in Fig. 5-5).

i Tip

With great care, entire systems can be lifted off rail if all orange tabs are unlocked, however this method can invite unnecessary risk to both the system (especially if large) and personnel. It is always recommended to fully assemble and disassemble systems directly on mounting rail.

5.5 Q.series XE Modules and Connection Detail

5.5.1 Q.series XE BC Communication Interfaces

For standard communication (configuration and data transfer), there are two possibilities when using the Q.series XE BC:

- Connect the Q.series XE BC (bus coupler) via EtherCAT cable. For this method, you must have an EtherCAT master available to perform configuration; refer to Section 5.6, *Q.series XE LED Flash Sequence Codes*, page 35 and Chapter 6, *System Configuration*, page 107 for more information.
- Connect the Q.series XE BC (bus coupler) via USB to a PC. For this method, you need a driver for the PC USB interface. Normally the driver is installed when connecting the module. If Windows already has a driver for USB-to-serial, a newer (more suitable driver) might not be installed when connecting the module. In this case you must install the driver manually.

5.5.2 Connecting the Q.series XE BC via EtherCAT Interface

Plug in an EtherCAT compatible RJ45 cable (not included) into the EC-IN port on the Q.series XE BC and connect the other end of the cable to the appropriate port on the EtherCAT master (PC). The Q.series XE BC (bus coupler) can be connected to a maximum of 10 measurement modules. If more than 10 modules are used, then additional bus couplers are required. The EC-OUT port on the Q.series XE BC is useful for connecting additional bus coupler devices; just connect the EC-OUT port on bus coupler #1 to the EC-IN port on bus coupler #2. The speeds of bus coupler EC-IN and EC-OUT interfaces are both 100Mbit/s.

5.5.3 Manually Installing the USB Interface Driver on a PC

For this you need the Future Technology Devices International (FTDI) driver “CDM vX.XX.XX WHQL Certified”; the X characters stand for the program version (must be at least 2.10.00).

You can manually install the most recent version of the driver via <http://www.ftdichip.com/Drivers/D2xx.htm>. For Windows, there is a link to a convenient setup executable in the comments column.

IMPORTANT

You need administrator rights for the D2XX driver installation.

1. Extract all contents of the compressed downloaded folder.
2. Right-click on the extracted file (CDMXXXXX_Setup.exe) and in the context menu select **Run as administrator** to install.
3. Click on **Extract** (Fig. 5-6, page 33).

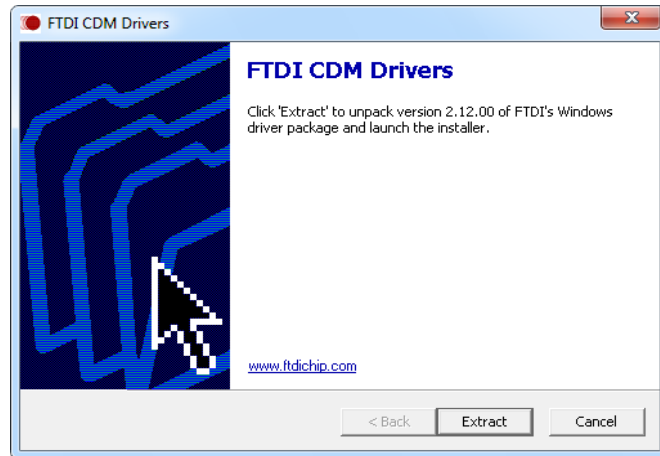

Fig. 5-6 Extracting the FTDI CDM driver

4. Click **Next** (Fig. 5-7) and follow the installation instructions.

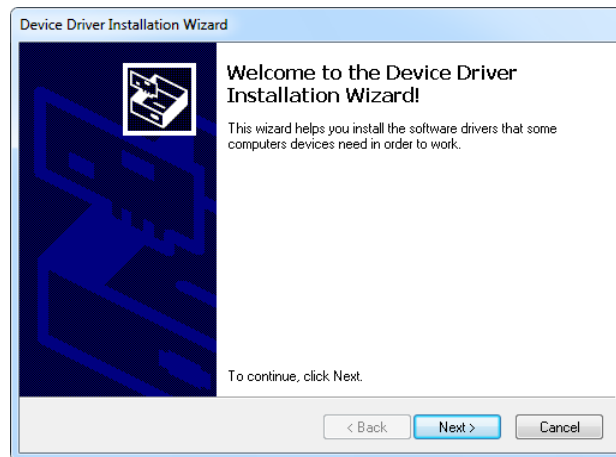

Fig. 5-7 Start the installation process

5. After installation, the final setup page indicates whether the driver files were properly installed (Fig. 5-8), click **Finish**.

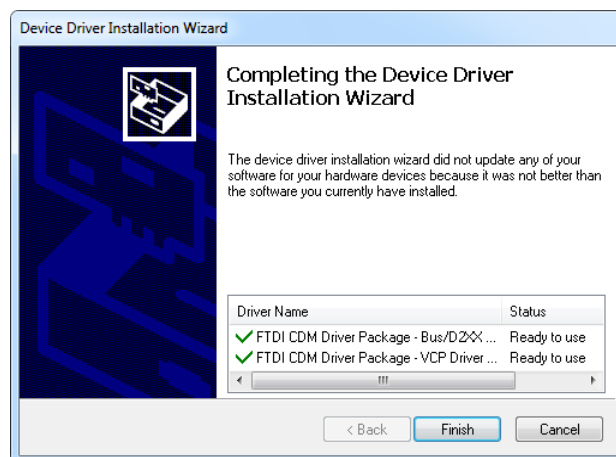

Fig. 5-8 Finishing the installation

It is recommended that you restart the PC after installation of the driver. Once the bus coupler is connected to a USB interface on the PC, the driver will be fully installed.

1. After installation, “USB Serial Port (COMx)” and “Device driver software has been successfully installed” are displayed in the taskbar. The x in COMx represents the interface used for the connection; you may have to specify this in the Gantner Instruments software *ICP100* via **Communication > Parameters**.

You can configure the modules with either *GI.bench* or *ICP100*; refer to Chapter 6, *System Configuration*, page 107.

5.6

Q.series XE LED Flash Sequence Codes

The Q.series XE BC (bus coupler) and measurement modules have three in-line LEDs on the front upper right edge and two LEDs on the EC-IN and EC-OUT communication ports: Blue LED on top, Green LED in middle, and RGB LED on bottom. These LEDs are labeled A, B, and C, respectively.

5.6.1

LED Codes for Q.series XE BC (Bus Coupler)

The LED labeled A indicates the bus coupler's status.

LED A	Explanation
Off	"Init" operating mode
Flashing (approx. 0.4Hz)	"Pre-Operational" operating mode
Flashing (approx. 1.2Hz)	"Safe Operational" operating mode
Flickering (fast flashing)	"Bootstrap" operating mode
On	"Operational" operating mode

The LEDs labeled C, EC-IN, and EC-OUT provide information about bus communication status.

LED	Explanation
EC-IN	Bus communication IN (EC_IN)
C	Bus communication LVDS (to modules)
EC-OUT	Bus communication OUT (EC_OUT)

The blue LED A stays lit continuously after the switch-on process (approx. 15 seconds) if the module has been connected properly.

5.6.2

LED Codes for Q.series XE Measurement Modules

Modules have three in-line LEDs on the front upper right edge: Blue LED on top, Green LED in middle, and RGB LED on bottom. In normal operation, all three LEDs are solidly on with no flashes. Depending on the error or operational procedure that occurs, the LEDs will flash in certain sequences providing the user a code to either diagnose the problem or be aware of the module's status. In the following illustrations, a small dash corresponds to brief flash and a large dash corresponds to a longer duration flash.

5.6.2.1 SOS; Configuration Error

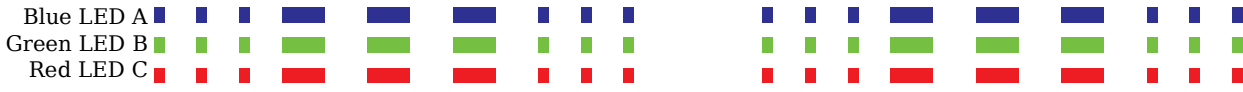

Fig. 5-9 Flashing sequence indicating an incorrect module type or there are no configurations stored in the socket

The configuration saved in the socket EPROM does not match the configuration within the connected module.

There are two likely reasons for this:

1. No stored configuration data exists in socket EPROM while *hot-swap* is enabled, i.e., when configuration data is expected.
2. The module type of the stored configuration data in the socket EPROM differs from the type of the connected module, thus a configuration incompatibility exists between both devices.

To remedy this, either change the module to the correct module type (same as stored in EPROM) or reconfigure the module via *GI.bench*. The new configuration is automatically saved to the socket EPROM.

5.6.2.2 Firmware Download in Progress



Fig. 5-10 Flashing sequence on downloading the module firmware

Module LEDs flash while the firmware download into the module is taking place. This is an operational procedure status LED code and does not indicate an error has occurred. No further action is required.

5.6.2.3 Activation of Downloaded Firmware



Fig. 5-11 Flashing sequence on activating the firmware

After the firmware has been downloaded, module LEDs will sequentially flash from top to bottom while the new firmware reconfigures the FPGA. Once complete, the module must restart. This is an operational procedure status LED code and does not indicate an error has occurred. No further action is required.

5.6.2.4

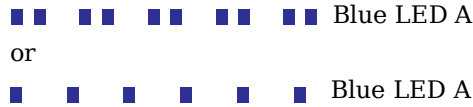
Error During Data Transmission*Fig. 5-12 Flashing sequence due to errors during data transmission*

Irregular blue LED flash sequences, as shown above, indicate a communication error. Check the following to determine a cause:

1. Are all the linking interfaces between module CPU boards and socket boards intact (e.g., internal components of modules)?
2. Are all the linking interfaces between all sockets (e.g., all exposed boards and their mating ports) completely intact and securely connected to form a single backplane?
3. Are all interface cables, if any, properly wired?
4. Are all linking interfaces between measurement modules and bus coupler(s) completely intact and connected properly?

After checking the above, restart the Q.series XE system by power cycling the connected voltage supply (wait for at least 60 seconds before turning the supply on again).

If the communication error is not remedied after the above steps, contact your local Gantner Instruments Sales and Service location for technical support.

5.6.3

Overview of Q.series XE Measurement Modules

Modules:	A 101	A 102	A 103	A 104	A 105	A 106	A 107	A 108	A 109	A 111	A 116
Signal inputs											
Voltage	X	X	X	X			X	X		X	
Current	X	X	X				X	X			
Potentiometer	X						X				
Resistance	X				X		X				
Pt100, Pt1000	X				X		X				
Thermocouple	X			X			X				
(Strain gages) full + half bridge	X	X				X	X ¹⁾				X
Strain gage quarter bridge	X ²⁾	X ²⁾				X ²⁾	X ²⁾				X
Inductive full and half bridge						X					
LVDT, RVDT						X					
IEPE/ICP [®] Sensor	X	X								X	
Piezoelectric Sensor											
Optical Sensor											
Digital input: frequency, pulse width, counter									X		
Digital input: Status	X	X	X			X		X	X		
Signal outputs											
Voltage		X				X			X		
Current		X							X		
Digital output: frequency, pulse width									X		
Digital output: Status	X	X	X			X		X	X		
Number of channels	2	1	8	8	4	2	4	8	4	4	8
Data rate (in Hz)	100 k	100 k	100	100	100	20k	20k	20k	100 k	100 k	20k
For description refer to page	40	45	49	51	53	55	59	64	66	68	70

1) Half bridge only with special Terminal

2) Quarter bridge with special Terminal

Modules:	A 121	A 123	A 124	A 127	A 128	A 141	A 146	F 108	D 101	D 104	D 105	D 107
Signal inputs												
Voltage	X	X	X	X	X							
Current	X											
Potentiometer	X											
Resistance	X											
Pt100, Pt1000	X							X				
Thermocouple			X									
(Strain gages) full + half bridge	X											
Strain gage quarter bridge							X					
Inductive full and half bridge												
LVDT, RVDT												
IEPE/ICP [®] Sensor	X											
Piezoelectric Sensor						X						
Optical Sensor								X ¹⁾				
Digital input: frequency, pulse width, counter									X			X
Digital input: Status									X	X		X
Signal outputs												
Voltage												
Current												
Digital output: frequency, pulse width									X			
Digital output: Status									X		X	
Number of channels	2	4	4	4	4	4	16	up to 8	8	16	16	6
Data rate (in Hz)	100 k	100 k	20k	100 k	100 k	100 k	10k	up to 50k	up to 100 k	20k	20k	1M
For description refer to page	80	83	85	87	90	93	94	N/A	99	100	102	103

¹⁾ Temperature, strain, pressure, acceleration, vibration, or displacement optical sensor

5.7

Q.series XE A101: Connecting Sensors and I/O

The Q.series XE A101 has two electrically isolated analog inputs and two digital inputs or outputs. The pin assignments of the two blue connector strips below are identical. Connection terminals are associated to numbers to help in identifying connections.

The designation GND identifies the measurement ground of an input while 0 V and +V designate the (external) supply voltage connections. Measurement ground and (external) supply voltage are electrically isolated in the module.

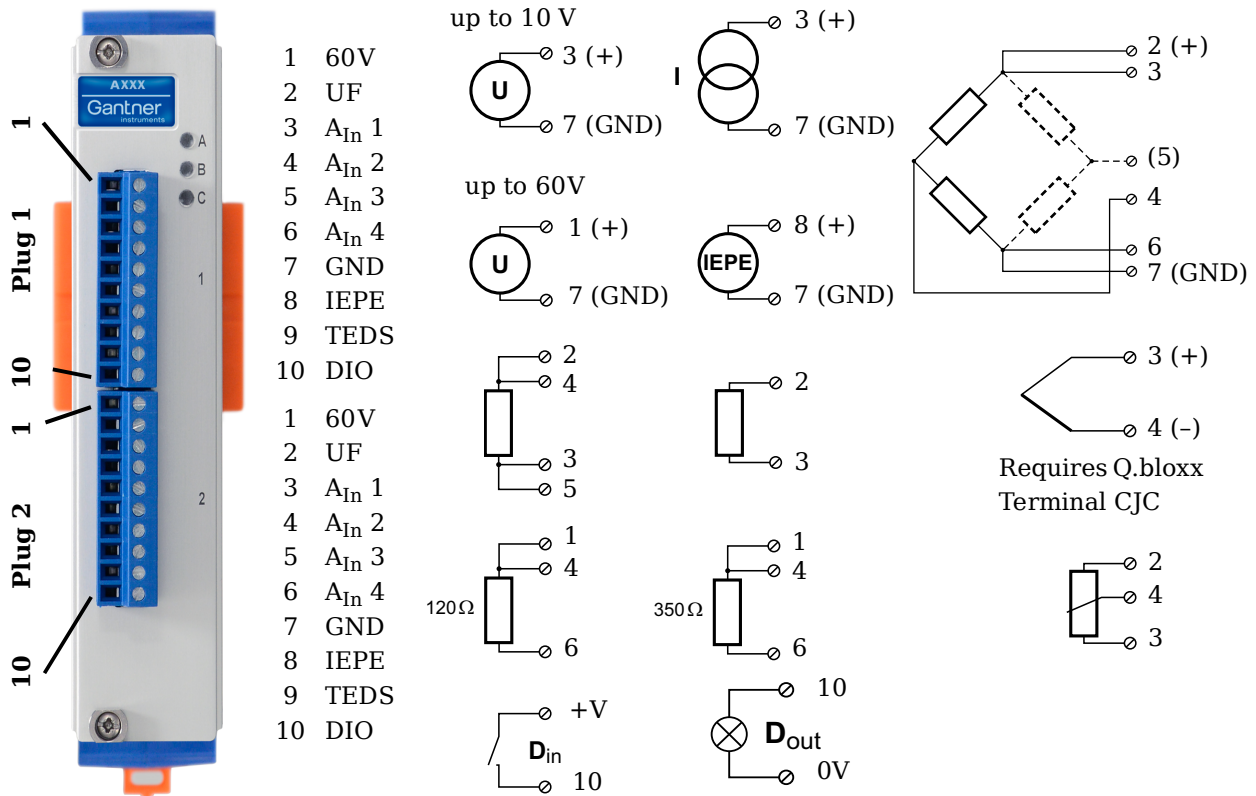

Fig. 5-13 Pin assignments for Q.series XE A101

i Tip

For additional information regarding functional procedures for various measurements, refer to Chapter 7 on page 151.

5.7.1

Voltage

For voltage measurements, two connection variants are available depending on the level of voltages to be measured: up to ±10V & up to ±60V. You can specify the data range you wish to use while configuring the channel using *GI.bench* (**Hardware defined** or **Maximum** and **Minimum** fields in *Value handling* settings).

! IMPORTANT

Attempting to measure voltages which exceed the admissible limitations will produce incorrect measurement data as inputs are protected against overvoltage and will therefore limit the input voltage to prevent damage.

Voltages up to 10V

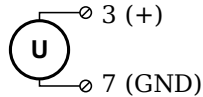

Voltages up to 60V

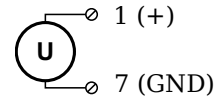

Fig. 5-14 A101, terminal wiring configuration for measurement of voltage

5.7.2

Current

For current measurements, an internal shunt resistance of 50Ω is integrated into the Q.series X A101 module. The internal shunt resistor will facilitate the measurement of currents up to 25mA. For current measurements higher than 25mA, configure the channel for voltage measurement and use an external shunt resistance terminal. The external shunt resistance terminal can be obtained under the designation *Q.bloxx Terminal SR* from Gantner Instruments or your domestic Gantner Instruments Sales and Service location; refer to Section 7.3, page 158.

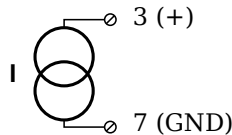

Fig. 5-15 A101, terminal wiring configuration for measurement of current, *Q.bloxx Terminal SR* necessary for signals exceeding 25mA

5.7.3

Potentiometer

For potentiometer measurements, resistances between 1kΩ and 10kΩ can be connected using a three-wire configuration.

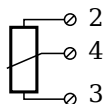

Fig. 5-16 A101, terminal wiring configuration for measurement with potentiometers

5.7.4

Resistance, Pt100, Pt1000

For resistance type and RTD (Pt100/1000) measurements, you may connect sensors using either a two-wire or four-wire configuration. You can specify the type of configuration you wish to use while configuring the channel within *GI.bench* (**Analog input type** in *General* settings).

2-wire circuit**4-wire circuit**

Fig. 5-17 A101, terminal wiring configuration for measurement with resistance type and Pt100/1000 probes

i Tip

Information regarding transducers and cables with sensing leads can be found in Chapter 7.1 on page 151.

5.7.5

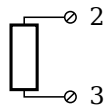
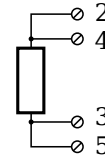
Thermocouple

For thermocouple measurements with *internal* cold junction compensation, you will need to use special cold junction compensation (CJC) terminals which will provide the necessary comparative measuring point for accurate measurement. CJC terminals can be obtained under the designation *Q.bloxx Terminal CJC-A101* from Gantner Instruments or your domestic Gantner Instruments Sales and Service location.

Alternatively, for thermocouple measurements with *external* cold junction compensation, you can use two thermocouples per temperature measurement or a reference temperature source.

You may connect the following types of thermocouples to the Q.series XE A101 module: B, E, J, K, L, N, R, S, T and U.

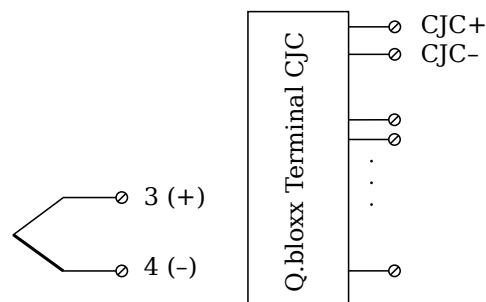

Fig. 5-18 A101, terminal wiring configuration for measurement with thermocouple using *Q.bloxx Terminal CJC-A101*

i Tip

You can find additional information regarding the necessity of a comparative measuring point for thermocouple measurements as well as additional information on thermocouple measurements with a reference temperature source in Section 7.4, *Measurements with Thermocouples*, page 159.

5.7.6**Full and Half-bridge Transducer**

For resistive *full bridge* (strain gage) measurements, all connections to the Q.series XE A101 terminal shown in the diagram below are necessary. If you are not utilizing a sensor with sensing leads, you must specify this during module configuration in *GI.bench* (**Analog input type** in *General* settings). In this case, inputs 3 and 6 remain open in the diagram below.

For resistive *half bridge* (strain gage) measurements, the dotted sides and connection 5 shown in the diagram below are omitted. The bridge excitation voltage provided by Q.series XE A101 modules is 2.5V.

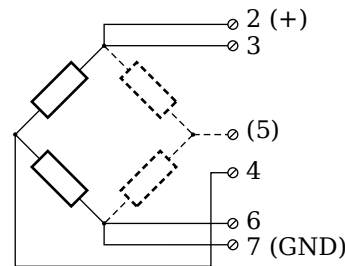

Fig. 5-19 A101, terminal wiring configurations for measurement with full and half bridges

i Tip

Information regarding transducers and cables with sensing leads can be found in Chapter 7.1 on page 151.

5.7.7**Quarter-bridge Strain Gage**

For resistive *quarter bridge* (strain gage) measurements, you will need a special bridge completion terminal which will provide the necessary bridge completion resistance; 120Ω or 350Ω. The bridge completion terminal can be obtained under the designation *Q.bloxx Terminal B4/120-A101* for 120Ω completion or *Q.bloxx Terminal B4/350-A101* for 350Ω completion from Gantner Instruments or your domestic Gantner Instruments Sales and Service location.

The bridge excitation voltage provided by Q.series XE A101 modules is 2.5V.

! IMPORTANT

The bridge completion terminals used must have the same resistance values as the strain gages used for measurement. All the necessary completion resistances are located within the *Q.bloxx Terminal B4/120-A101* or *Q.bloxx Terminal B4/350-A101* provided by Gantner Instruments. For all channel configurations where these terminals are used, in *GI.bench*, you must select **Bridge, Resistive Full (4- or 6-Wire)** as **Analog input type**.

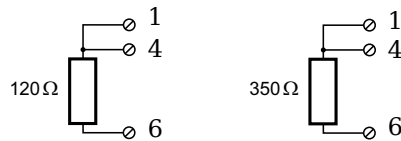

Fig. 5-20 A101, terminal wiring configurations for measurement with strain gage quarter bridge using either *Q.bloxx Terminal B4/120-A101* or *Q.bloxx Terminal B4/350-A101*

5.7.8

IEPE/ICP®

For IEPE/ICP® measurements, the connected sensor is provided a current supply of 4.5 mA from the Q.series XE A101 module.

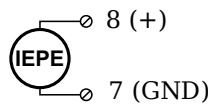

Fig. 5-21 A101, terminal wiring configuration for measurement with IEPE or ICP® sensors

5.7.9

Digital Input and Output

On each Q.series XE A101 terminal, a single contact is available for use as either a digital input or digital output. You can use the appropriate function depending on the terminal wiring configurations shown in the following diagram.



Fig. 5-22 A101, terminal wiring configurations for digital input and output

The digital input is active (high level) when the applied voltage signal exceeds the threshold of 10V.

5.8

Q.series XE A102: Connecting Sensors and I/O

The Q.series XE A102 has one analog input, one analog output, four digital inputs, and two digital outputs, and each electrically isolated from one another. The pin assignments for the connector strips on are *not* identical. The connection terminals have numbers for identifying connections.

The designation GND identifies the measurement ground of an input while 0V and +V designate the (external) supply voltage connections. Measurement ground and (external) supply voltage are electrically isolated in the module.

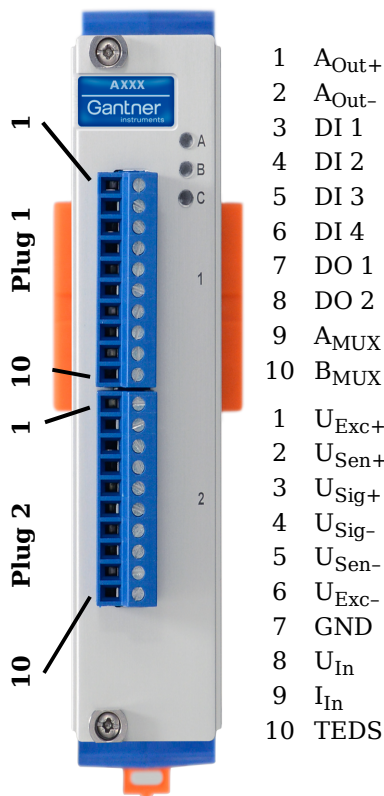

- 1 A_{Out+}
 - 2 A_{Out-}
 - 3 DI 1
 - 4 DI 2
 - 5 DI 3
 - 6 DI 4
 - 7 DO 1
 - 8 DO 2
 - 9 A_{MUX}
 - 10 B_{MUX}
-
- 1 U_{Exc+}
 - 2 U_{Sen+}
 - 3 U_{Sig+}
 - 4 U_{Sig-}
 - 5 U_{Sen-}
 - 6 U_{Exc-}
 - 7 GND
 - 8 U_{In}
 - 9 I_{In}
 - 10 TEDS

Plug 1, inputs

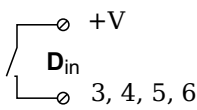

Plug 1, outputs

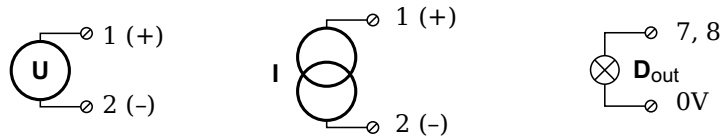

Plug 2, inputs

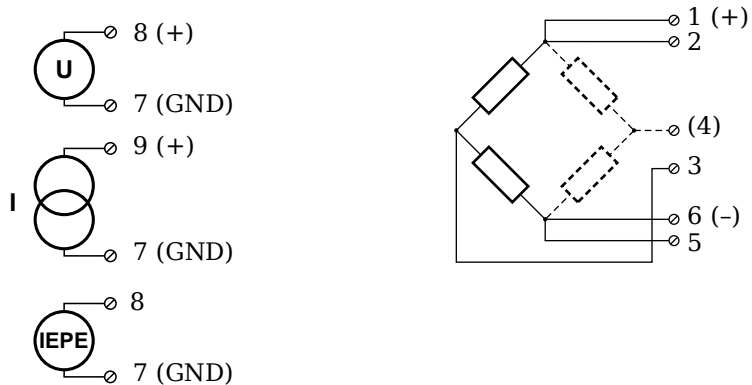

Fig. 5-23 Pin assignments for Q.series XE A102

5.8.1

Voltage

For voltage measurements, you can connect signals of up to ±10V via Terminal 2.

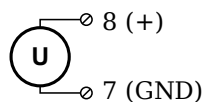

Fig. 5-24 A102, terminal wiring configuration for measurement of voltage, available via Terminal 2 only

! **IMPORTANT**

Attempting to measure voltages which exceed the admissible limitations will produce incorrect measurement data as inputs are protected against overvoltage and will therefore limit the input voltage to prevent damage.

5.8.2

Current

For current measurements, an internal shunt resistance of 50Ω is integrated into the Q.series XE A102 module. The internal shunt resistor will facilitate the measurement of currents of up to 25mA via Terminal 2. For current measurements higher than 25mA, configure the module for voltage measurement and use an external shunt resistance terminal. The external shunt resistance terminal can be obtained under the designation *Q.bloxx Terminal SR* from Gantner Instruments or your domestic Gantner Instruments Sales and Service location; refer to Section 7.3, page 158.

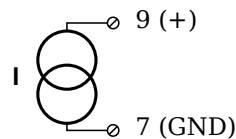

Fig. 5-25 A102, terminal wiring configuration for measurement of current, *Q.bloxx Terminal SR* necessary for signals exceeding 25mA, available via Terminal 2 only

5.8.3

Full and Half-bridge Transducer

For resistive *full bridge* (strain gage) measurements, all connections to the Q.series XE A102 terminal shown in the diagram below are necessary. If you are not utilizing a sensor with sensing leads, you must specify this during module configuration in *GI.bench* (**Analog input type** in *General* settings). In this case, inputs 2 and 5 remain open in the diagram below.

For resistive *half bridge* (strain gage) measurements, the dotted sides and connection 4 shown in the diagram below are omitted. The bridge excitation voltage provided by Q.series XE A102 modules is configurable via *GI.bench* between 1V, 2.5V, 5V and 10V.

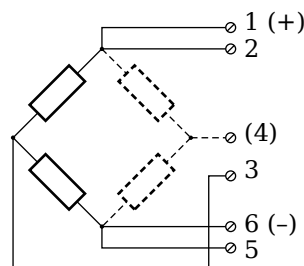

Fig. 5-26 A102, terminal wiring configurations for measurement with full and half bridges, available via Terminal 2 only

i Tip

Information regarding transducers and cables with sensing leads can be found in Chapter 7.1 on page 151.

5.8.4**Quarter-bridge Strain Gage**

For resistive *quarter bridge* (strain gage) measurements, you will need a special bridge completion terminal which will provide the necessary bridge completion resistance; 120Ω or 350Ω. The bridge completion terminal can be obtained under the designation *Q.bloxx Terminal B4/120-A102* for 120Ω completion or *Q.bloxx Terminal B4/350-A102* for 350Ω completion from Gantner Instruments or your domestic Gantner Instruments Sales and Service location.

The bridge excitation voltage provided by Q.series XE A102 modules is configurable via *GI.bench* between 1V, 2.5V, 5V and 10V.

! IMPORTANT

The bridge completion terminals used must have the same resistance values as the strain gages used for measurement. All the necessary completion resistances are located within the *Q.bloxx Terminal B4/120-A102* or *Q.bloxx Terminal B4/350-A102* provided by Gantner Instruments. For all channel configurations where these terminals are used, in *GI.bench*, you must select **Bridge, Resistive Full (4- or 6-Wire)** as **Analog input type**.

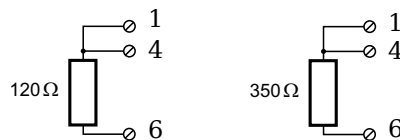

Fig. 5-27 A102, terminal wiring configurations for measurement with strain gage quarter bridge using either *Q.bloxx Terminal B4/120-A102* or *Q.bloxx Terminal B4/350-A102*, available via Terminal 2 only

5.8.5**IEPE/ICP®**

For IEPE/ICP® measurements, the connected sensor is provided a current supply of 4.5mA from the Q.series XE A102 module. Such measurements are only available via Terminal 2.

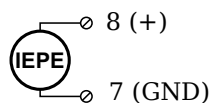

Fig. 5-28 A102, terminal wiring configuration for measurement with IEPE or ICP® sensors, available via Terminal 2 only

5.8.6

Analog Output

For analog output, two output configurations are available to you via Terminal 1 only: voltage or current. Select the preferred output variant in *GI.bench* (**Analog output type** field in *General* settings).



Fig. 5-29 A102, terminal wiring configuration for analog output of voltage or current, available via Terminal 1 only

5.8.7

Digital Input and Output

On Terminal 1 of the Q.series XE A102, contacts are available for four digital inputs and two digital outputs. You can use the appropriate function(s) depending on the terminal wiring configurations shown in the following diagram.

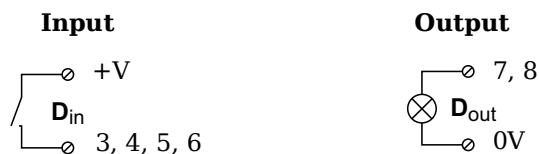

Fig. 5-30 A102, terminal wiring configurations for digital input and output, available via Terminal 1 only

The digital input is active (high level) when the applied voltage signal exceeds the threshold of 10V.

5.9

Q.series XE A103: Connecting Sensors and I/O

The Q.series XE A103 has eight electrically isolated analog inputs and two digital inputs and outputs. The pin assignments of the two blue connector strips below are identical. Connection terminals are associated to numbers to help in identifying connections. The designation GND identifies the measurement ground of an input while 0V and +V designate the (external) supply voltage connections. Measurement ground and (external) supply voltage are electrically isolated in the module.

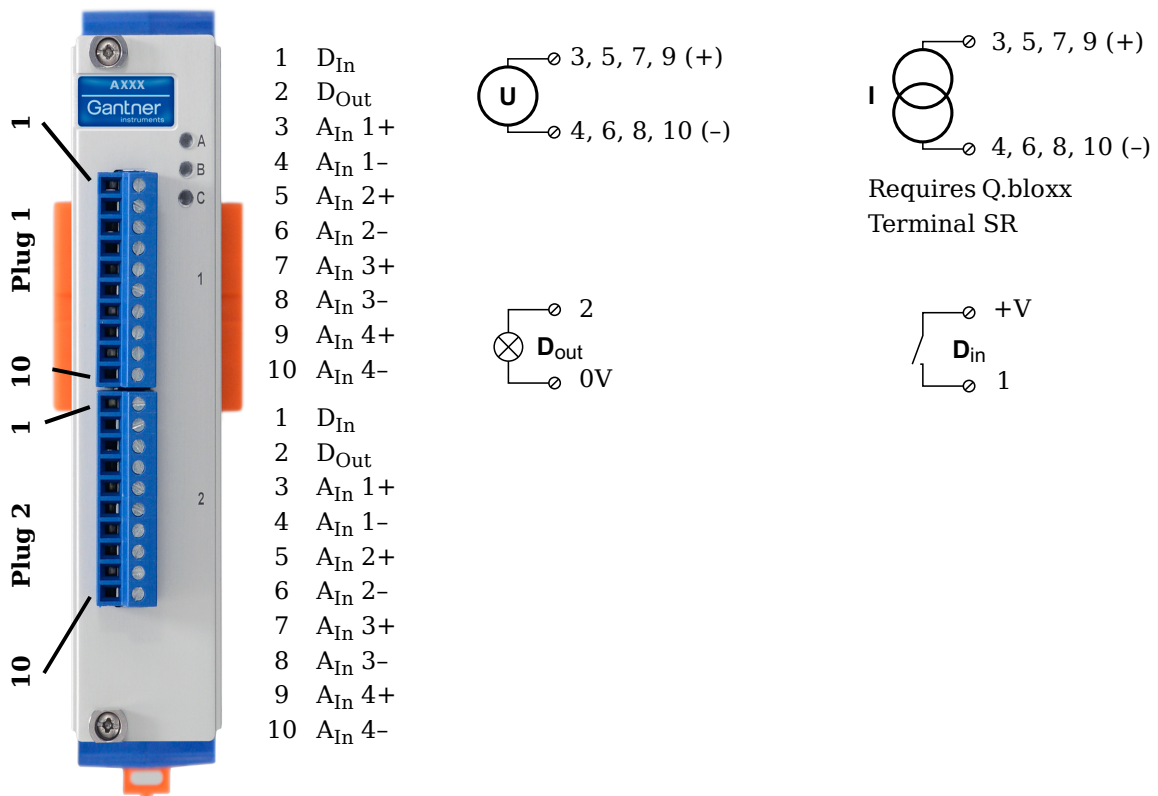

Fig. 5-31 Pin assignments for Q.series XE A103

i Tip

Information regarding transducers and cables with sensing leads can be found in Chapter 7.1 on page 151.

5.9.1

Voltage

For voltage measurements, you can connect signals of up to $\pm 10V$.

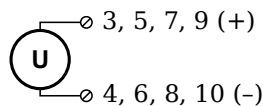

Fig. 5-32 A103, terminal wiring configuration for measurement of voltage

! IMPORTANT

Attempting to measure voltages which exceed the admissible limitations will produce incorrect measurement data as inputs are protected against overvoltage and will therefore limit the input voltage to prevent damage.

5.9.2

Current

For current measurements, an external shunt resistance terminal is needed. The external shunt resistance terminal is obtained under the designation *Q.bloxx Terminal SR* from Gantner Instruments or your domestic Gantner Instruments Sales and Service location. The *Q.bloxx Terminal SR* facilitates the measurement of currents up to 25mA for the Q.series XE A103 module.

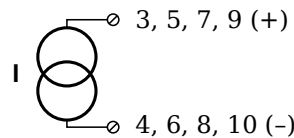

Fig. 5-33 A103, terminal wiring configurations for measurement of current using the *Q.bloxx Terminal SR*

5.9.3

Digital Input and Output

On each Q.series XE A103 terminal, there are two contacts available for a digital input and digital output. You can use the appropriate function(s) depending on the terminal wiring configurations shown in the following diagram.

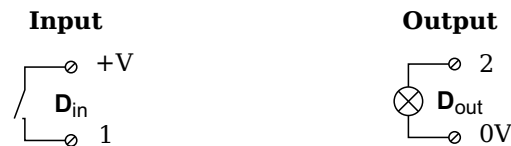

Fig. 5-34 A103, terminal wiring configurations for digital input and output

The digital input is active (high level) when the applied voltage signal exceeds the threshold of 10V.

5.10

Q.series XE A104 TCK: Connecting sensors

The Q.series XE A104 has eight electrically isolated analog inputs for thermocouples or voltages. The pin assignments of the two blue connector strips below are identical. Connection terminals are associated to numbers to help in identifying connections. A TCK variant of the Q.series XE A104 is also available (Fig. 5-35). Measurement ground and (external) supply voltage are electrically isolated within the module.

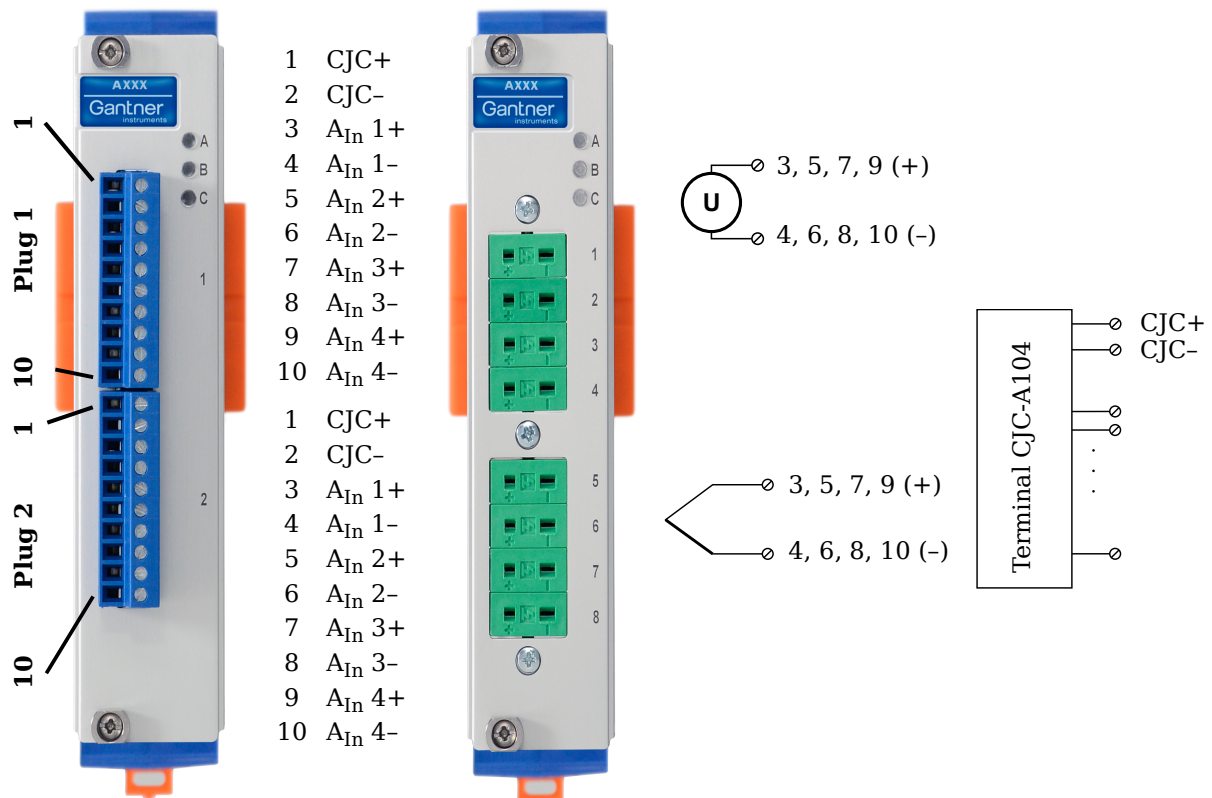

Fig. 5-35 Pin assignments for Q.series XE A104 and TCK variant

i Tip

Information regarding measuring with thermocouples can be found in Chapter 7.4 on page 159.

5.10.1

Voltage

For voltage measurements, you can connect signals of up to ±80mV.

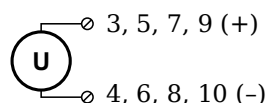

Fig. 5-36 A104, terminal wiring configurations for measurement of voltage

! **IMPORTANT**

Attempting to measure voltages which exceed the admissible limitations will produce incorrect measurement data as inputs are protected against overvoltage and will therefore limit the input voltage to prevent damage.

5.10.2

Thermocouple

For thermocouple measurements with *internal* cold junction compensation, you will need to use special cold junction compensation (CJC) terminals which will provide the necessary comparative measuring point for accurate measurement. The CJC terminals can be obtained under the designation *Q.bloxx Terminal CJC-A104* from Gantner Instruments or your domestic Gantner Instruments Sales and Service location. The TCK variant of the Q.series XE A104 module does not require the *Q.bloxx Terminal CJC-A104* for temperature measurements.

Alternatively, for thermocouple measurements with *external* cold junction compensation, you can also use two thermocouples per temperature measurement or a reference temperature source.

You may connect the following types of thermocouples to the Q.series XE A101 module: B, E, J, K, L, N, R, S, T and U.

i **Tip**

You can find additional information regarding the necessity of a comparative measuring point for thermocouple measurements as well as additional information on thermocouple measurements with a reference temperature source in.

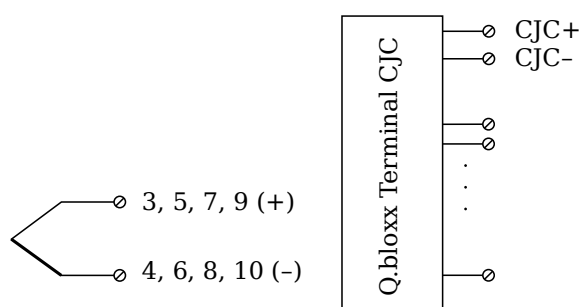

Fig. 5-37 A104, terminal wiring configurations for measurement with thermocouples using *Q.bloxx Terminal CJC-A104*

5.11

Q.series XE A105: Connecting Sensors

The Q.series XE A105 has four electrically isolated analog inputs. The pin assignments of the two blue connector strips below are identical. Connection terminals are associated to numbers to help in identifying connections.

The designation GND identifies the measurement ground of an input. Measurement ground and (external) supply voltage are electrically isolated in the module.

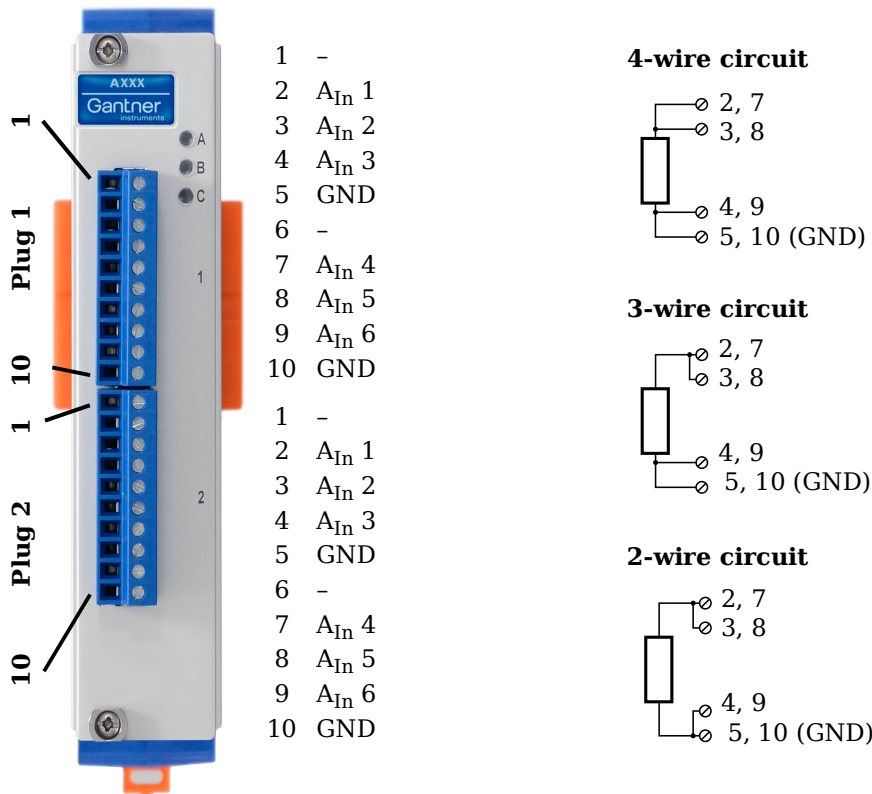

Fig. 5-38 Pin assignments for Q.series XE A105

i Tip

For additional information regarding functional procedures for various measurements, refer to Chapter 7 on page 151.

5.11.1

Resistance, Pt100, Pt1000

For resistance type and RTD (Pt100/1000) measurements, you may connect sensors using either a two-wire, three-wire or four-wire configuration. You can specify the type of configuration you wish to use while configuring the channel within *GI.bench* (**Analog input type** in settings).

In addition to configuring the channel in *GI.bench*, you must also ensure for each configuration type that all terminations are connected (i.e. for two- and three-wire configurations, unused terminations must be bridged).

4-wire circuit

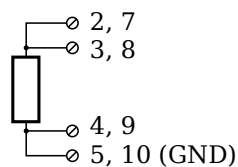

2-wire circuit

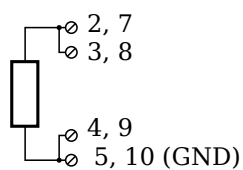

3-wire circuit

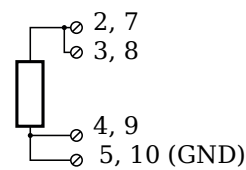

Fig. 5-39 A105, terminal wiring configurations for measurement with resistance and Pt100/1000 probes

i Tip

For additional important information regarding using resistive type transducer measurements, see Section 7.1, page 151.

5.12

Q.series XE A106: Connecting Sensors and I/O

The Q.series XE A106 has two electrically isolated analog inputs, two analog outputs and four digital inputs and outputs. The pin assignments of the two connector strips are identical and the connection terminals have numbers for identifying connections. The designation GND identifies the ground for the analog output while 0 V and +V designate the (external) supply voltage connections. The ground and (external) supply voltage connections are electrically isolated in the module.

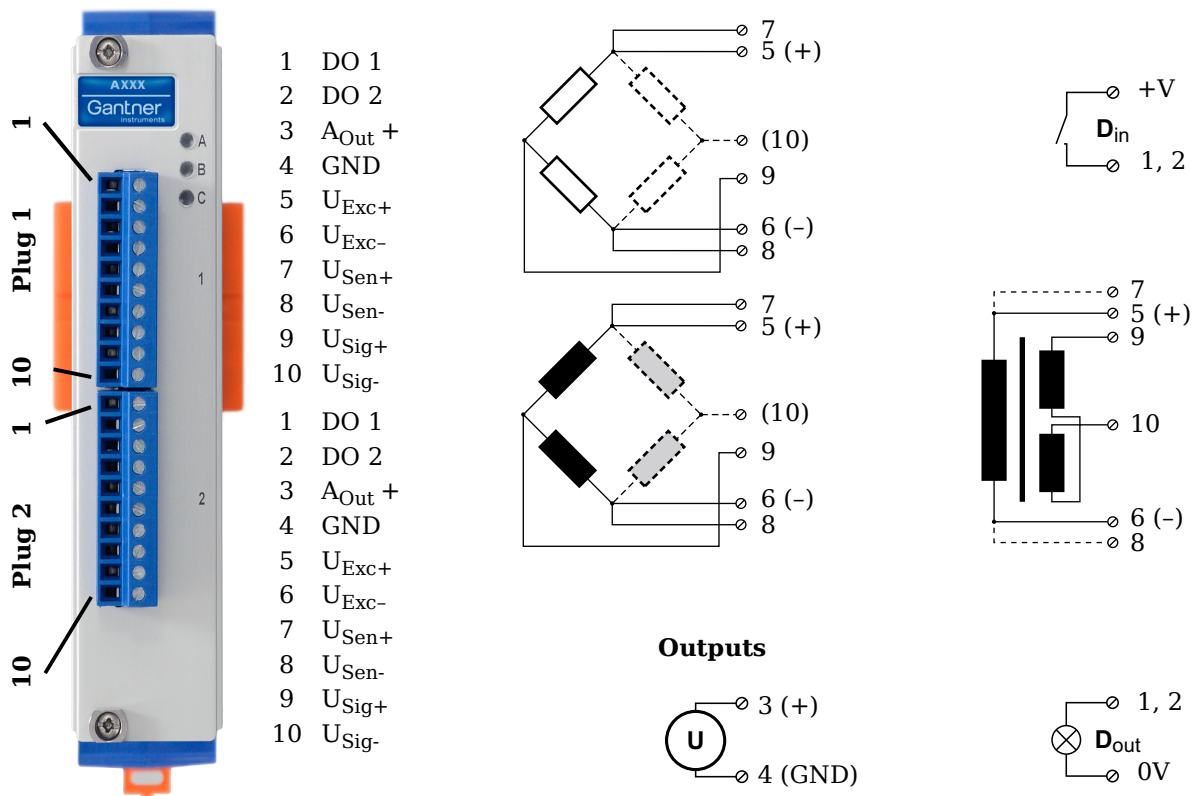

Fig. 5-40 Pin assignment for Q.series XE Module A106

i Tip

For additional information regarding functional procedures for various measurements, refer to Chapter 7 on page 151.

5.12.1

Full and Half-bridge Transducer

For resistive *full bridge* (strain gage) measurements, all connections to the Q.series XE A106 terminal shown in the diagram below are necessary. If you are not utilizing a sensor with sensing leads, you must specify this during module configuration in *GI.bench* (**Analog input type** in settings). In this case, inputs 7 and 8 remain open in the diagram below.

For resistive *half bridge* (strain gage) measurements, the dotted sides and connection 10 shown in the diagram below are omitted. The bridge excitation voltage provided by the Q.series XE A106 module can be either 2.5V or 5V (DC or CF). In *GI.bench*, you can specify the supply voltage and carrier frequency in the **Sensor** and **Analog input type** fields in *Variable settings*, respectively.

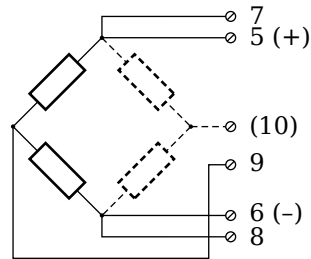

Fig. 5-41 A106, terminal wiring configurations for measurement with full and half bridges

i Tip

For additional important information regarding using resistive type transducer measurements, see Section 7.1, page 151.

5.12.2

Quarter-bridge Strain Gage

For resistive quarter bridge (strain gage) measurements, you will need a special bridge completion terminal which will provide the necessary bridge completion resistance; 120Ω or 350Ω. The bridge completion terminal can be obtained under the designation *Q.bloxx Terminal B4/120-A106* for 120Ω completion or *Q.bloxx Terminal B4/350-A106* for 350Ω completion from Gantner Instruments or your domestic Gantner Instruments Sales and Service location.

The bridge excitation voltage provided by the Q.series XE A106 module can be either 2.5V or 5V (DC or CF). In *GI.bench*, you can specify the supply voltage and carrier frequency in the **Sensor** and **Analog input type** fields in *Variable settings*, respectively.

! IMPORTANT

The bridge completion terminals used must have the same resistance values as the strain gages used for measurement. All the necessary completion resistances are located within the *Q.bloxx Terminal B4/120-A106* or *Q.bloxx Terminal B4/350-A106* provided by Gantner Instruments. Due to this, in *GI.bench*, select *Bridge, Resistive Half (3- or 5-Wire)* as the **Analog input type** for all channel configurations where these terminals are used.

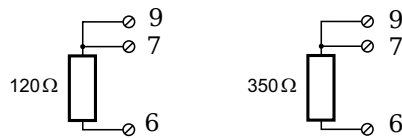

Fig. 5-42 A106, terminal wiring configurations for measurement with strain gage quarter bridge using either Q.bloxx Terminal B4/120-A106 or Q.bloxx Terminal B4/350-A106

5.12.3

Inductive Full and Half-bridge Transducer

For inductive *full bridge* (strain gage) measurements, all connections to the Q.series XE A106 module shown in the diagram below are necessary. If you are not utilizing a sensor with sensing leads, you must specify this during module configuration in *GI.bench* (**Analog input type** in settings).

For resistive *half bridge* (strain gage) measurements, the dotted sides and connection 10 in the diagram shown below are omitted. The bridge excitation voltage provided by the Q.series XE A106 module can be either 2.5V or 5V. In *GI.bench*, you can specify the supply voltage in the **Sensor** field in *Variable settings*.

! IMPORTANT

Inductive sensors can only be configured as **CF 4800Hz** (carrier frequency) for the **Analog input type** field in *Variable settings* in *GI.bench*. This is because inductive sensors cannot operate using direct voltage (DC) or a 600Hz carrier frequency.

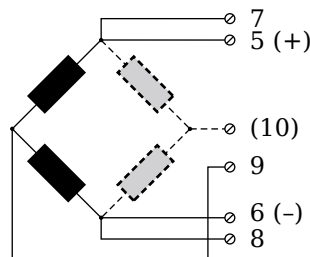

Fig. 5-43 A106, terminal wiring configurations for measurement with inductive full and half bridges

5.12.4

LVDT, RVDT

For inductive LVDT or RVDT measurements, sensor connections to the Q.series XE A106 module are shown in the diagram below. If you are not utilizing a sensor with sensing leads, you must specify this during module configuration in *GI.bench* (**Analog input type** in settings).

The bridge excitation voltage provided by the Q.series XE A106 module can be either 2.5V or 5V. In *GI.bench*, you can specify the supply voltage in the **Sensor** field in *Variable settings*.

! **IMPORTANT**

Inductive sensors can only be configured as **CF 4800Hz** (carrier frequency) for the **Analog input type** field in *Variable settings* in *GI.bench*. This is because inductive sensors cannot operate using direct voltage (DC) or a 600Hz carrier frequency.

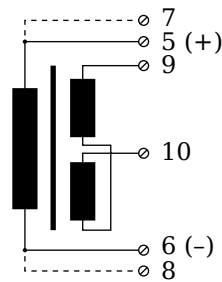

Fig. 5-44 A106, terminal wiring configurations for measurement with LVDT and RVDT

5.12.5

Analog Output

For analog output, both terminals are capable of analog voltage output. Select the preferred output terminal in *GI.bench* (**Terminal** field in *Variable settings*).

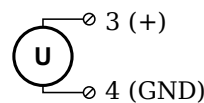

Fig. 5-45 A106, terminal wiring configuration for analog voltage output

5.12.6

Digital Input and Output

On each Q.series XE A106 terminal, there are two contacts available for either a digital input or digital output. You can use the appropriate function(s) depending on the terminal wiring configurations shown in the following diagram.



Fig. 5-46 A106, terminal wiring configurations for digital input and output

The digital input is active (high level) when the applied voltage signal exceeds the threshold of 10V.

5.13

Q.series XE A107: Connecting Sensors

The Q.series XE A107 has four electrically isolated analog inputs. The pin assignment of the two connector strips is identical and the connection terminals have numbers for identifying the connections.

The designation GND identifies the measurement ground of an input. The four inputs (UF to GND) and (external) supply voltage are also electrically isolated from each other in the module.

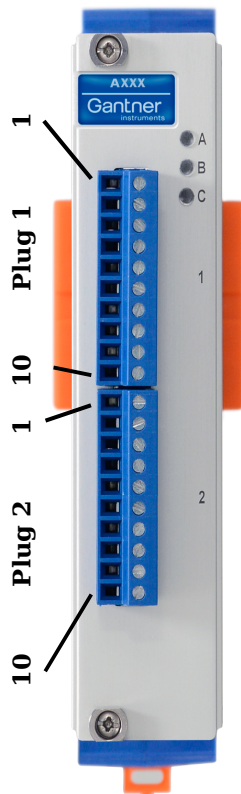

- 1 UF
 - 2 A_{In} 1
 - 3 A_{In} 2
 - 4 A_{In} 3
 - 5 GND
 - 6 UF
 - 7 A_{In} 1
 - 8 A_{In} 2
 - 9 A_{In} 3
 - 10 GND
-
- 1 UF
 - 2 A_{In} 1
 - 3 A_{In} 2
 - 4 A_{In} 3
 - 5 GND
 - 6 UF
 - 7 A_{In} 1
 - 8 A_{In} 2
 - 9 A_{In} 3
 - 10 GND

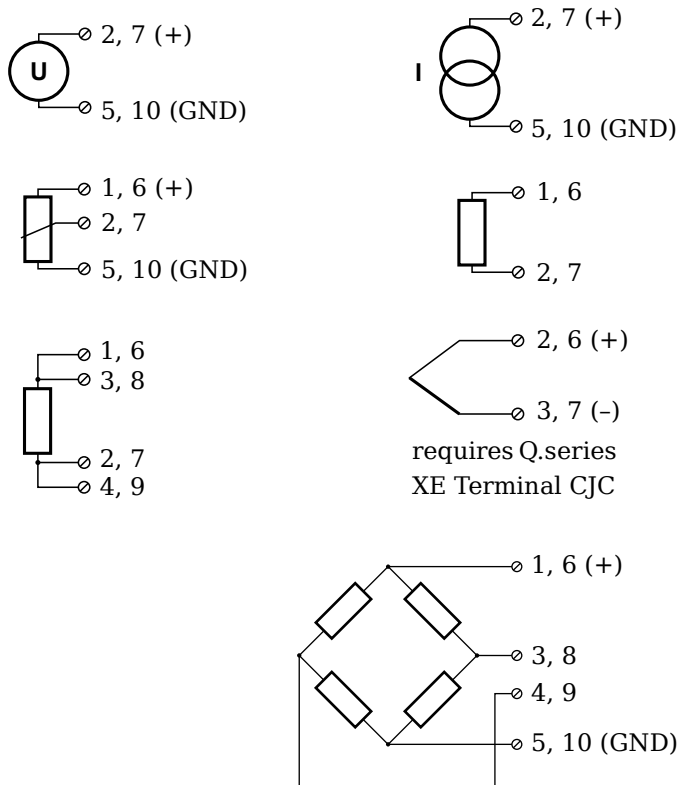

Fig. 5-47 Pin assignments for Q.series XE A107

i Tip

For additional information regarding functional procedures for various measurements, refer to Chapter 7 on page 151.

5.13.1

Voltage

For voltage measurements, you can connect signals of up to ±10V.

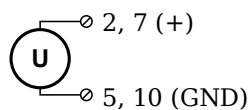

Fig. 5-48 A107, terminal wiring configurations for measurement of voltage

! IMPORTANT

Attempting to measure voltages which exceed the admissible limitations will produce incorrect measurement data as inputs are protected against overvoltage and will therefore limit the input voltage to prevent damage.

5.13.2

Current

For current measurements, an internal shunt resistance of 50Ω is integrated into the Q.series X A107 module. The internal shunt resistor will facilitate the measurement of currents of up to 25mA. For current measurements higher than 25mA, configure the module for voltage measurement and use an external shunt resistance terminal. The external shunt resistance terminal can be obtained under the designation *Q.bloxx Terminal SR* from Gantner Instruments or your domestic Gantner Instruments Sales and Service location; refer to Section 7.3, *Current Measurements with External Shunt*, page 158.

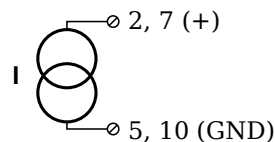

Fig. 5-49 A107, terminal wiring configurations for measurement of current, *Q.bloxx Terminal SR* necessary for signals exceeding 25mA

5.13.3

Potentiometer

For potentiometer measurements, resistances between 1k Ω and 10k Ω can be connected using a three-wire configuration.

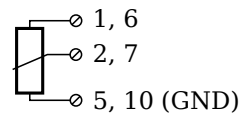

Fig. 5-50 A107, terminal wiring configurations for measurement with potentiometers

5.13.4

Resistance, Pt100, Pt1000

For resistance type and RTD (Pt100/1000) measurements, you may connect sensors using either a two-wire or four-wire configuration. You can specify the type of configuration you wish to use while configuring the channel within *GI.bench* (**Analog input type** in settings).



Fig. 5-51 A107, terminal wiring configurations for measurement with resistance and Pt100/1000 probes

i Tip

Information about the types of configurations available to you and their respective advantages and disadvantages can be found in Section 7.1, *Connecting Transducers with Sensing Leads*, page 151.

5.13.5

Thermocouple

For thermocouple measurements with *internal* cold junction compensation, you will need to use special cold junction compensation (CJC) terminals which will provide the necessary comparative measuring point for accurate measurement. The CJC terminals can be obtained under the designation *Q.bloxx Terminal CJC-A107* from Gantner Instruments or your domestic Gantner Instruments Sales and Service location. The TCK variant of the Q.series XE A107 module does not require the *Q.bloxx Terminal CJC-A107* for temperature measurements.

Alternatively, for thermocouple measurements with *external* cold junction compensation, you can also use two thermocouples per temperature measurement or a reference temperature source.

You may connect the following types of thermocouples to the Q.series XE A107 module: B, E, J, K, L, N, R, S, T and U.

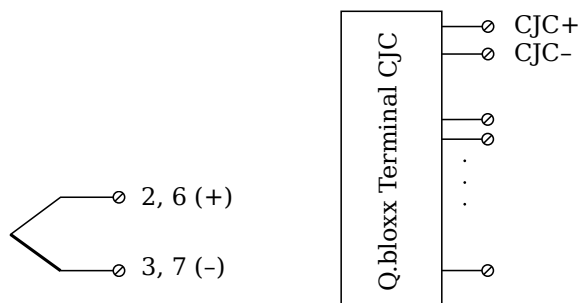

Fig. 5-52 A107, terminal wiring configurations for measurement with thermocouple using Q.bloxx Terminal CJC-A107

i Tip

You can find additional information regarding the necessity of a comparative measuring point for thermocouple measurements as well as additional information on thermocouple measurements with a reference temperature source in Section 7.4, *Measurements with Thermocouples*, page 159.

5.13.6

Full-bridge Transducer

For resistive *full bridge* (strain gage) measurements, the four connections to the Q.series XE A107 terminal shown in the diagram below are necessary. If your sensor has sensing leads, connect them to the relevant supply lines (1 and 5 or 6 and 10).

The bridge excitation voltage provided by the Q.series XE A107 module is 2.5V.

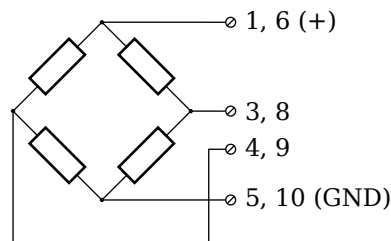

Fig. 5-53 A107, terminal wiring configurations for measurement with full bridges

5.13.7

Half and Quarter-bridge Strain gage

For resistive *half* and *quarter* bridge (strain gage) measurements, you will need a special bridge completion terminal which will provide the necessary bridge completion resistance; 120Ω or 350Ω. The bridge completion terminal can be obtained under the designation *Q.bloxx Terminal B4/120-A107* for 120Ω completion or *Q.bloxx Terminal B4/350-A107* for 350Ω completion from Gantner Instruments or your domestic Gantner Instruments Sales and Service location.

The bridge excitation voltage provided by Q.series XE A107 modules is 2.5V.

! IMPORTANT

The bridge completion terminals used must have the same resistance values as the strain gages used for measurement. All the necessary completion resistances are located within the *Q.bloxx Terminal B4/120-A107* or *Q.bloxx Terminal B4/350-A107* provided by Gantner Instruments. Due to this, in *GI.bench*, select *Bridge, Resistive Full (4-Wire)* as the **Analog input type** for all channel configurations where these terminals are used.

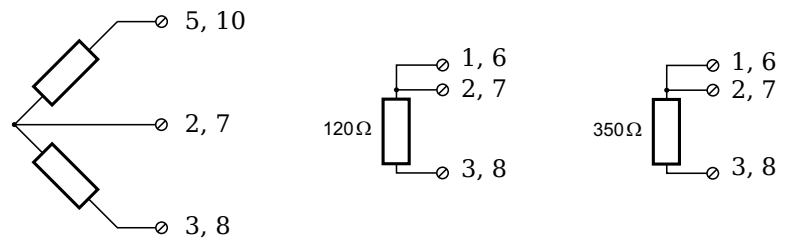

Fig. 5-54 A107, terminal wiring configurations for measurement with strain gage half and quarter bridge using either Q.bloxx Terminal B4/120-A107 or Q.bloxx Terminal B4/350-A107

5.14

Q.series XE A108: Connecting Sensors and I/O

The Q.series XE A108 has eight electrically isolated analog inputs and two digital inputs and outputs. Pin assignments of the two connector strips is identical and the connection terminals have numbers for identifying the connections.

The designations 0 V and +V represent the (external) supply voltage connections. Measurement connections and (external) supply voltage are electrically isolated in the module.

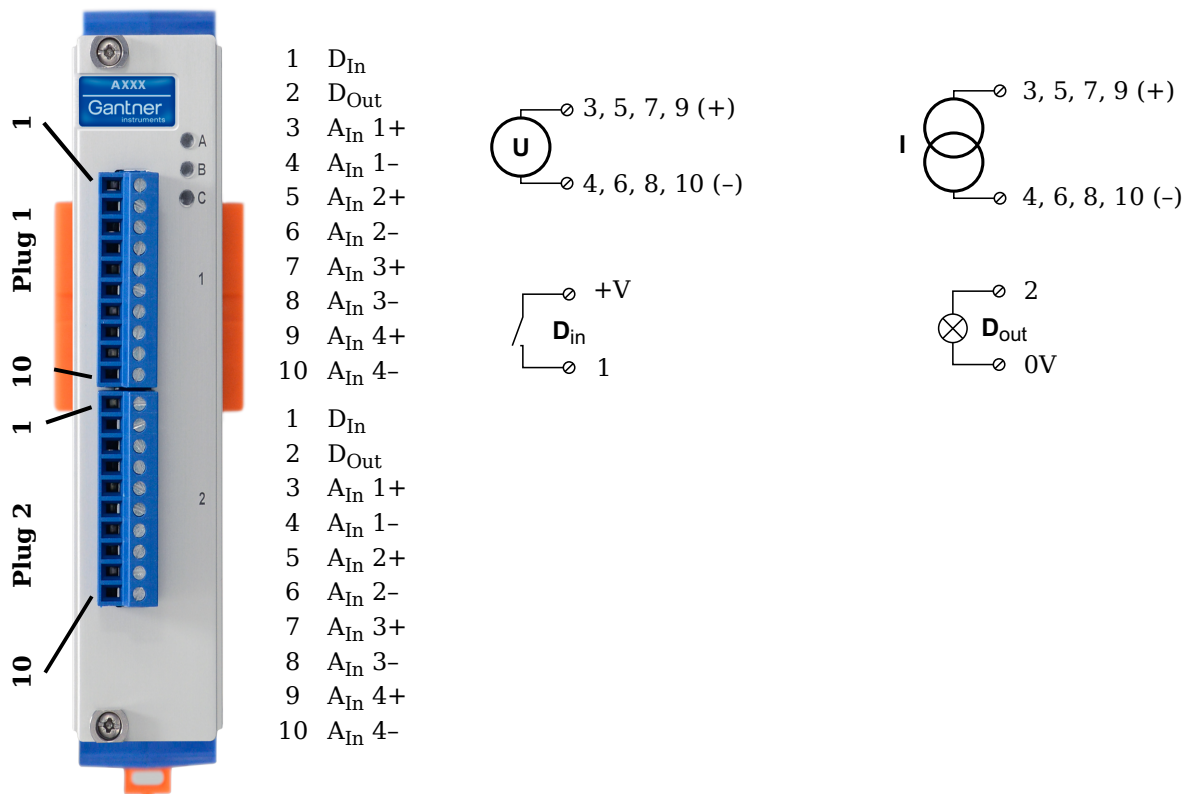

Fig. 5-55 Pin assignments for Q.series XE A108

i Tip

For additional information regarding functional procedures for various measurements, refer to Chapter 7 on page 151.

5.14.1

Voltage

For voltage measurements, you can connect signals up to ±10V.

! **IMPORTANT**

Attempting to measure voltages which exceed the admissible limitations will produce incorrect measurement data as inputs are protected against overvoltage and will therefore limit the input voltage to prevent damage.

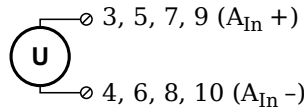

Fig. 5-56 A108, terminal wiring configurations for measurement of voltage (terminal version); for BNC variant, inner contact is A_{In+} and outer conductor is A_{In-}

5.14.2

Current

For current measurements, an external shunt resistance terminal is needed. The external shunt resistance terminal is obtained under the designation *Q.bloxx Terminal SR* from Gantner Instruments or your domestic Gantner Instruments Sales and Service location. The *Q.bloxx Terminal SR* facilitates the measurement of currents up to 25mA for terminal versions of the Q.series XE A108 module.

For the BNC version, you must use a suitable shunt resistance to determine the current from the voltage drop. For current measurements using BNC version of Q.series XE A108, configure the module for voltage measurement.

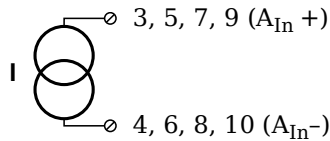

Fig. 5-57 A108, terminal wiring configurations for measurement of current using the *Q.bloxx Terminal SR*

5.14.3

Digital Input and Output

For terminal versions of the Q.series XE A108 module, two contacts are available for a digital input and digital output. You can use the appropriate function depending on the terminal wiring configurations shown in the following diagrams.



Fig. 5-58 A108, terminal wiring configurations for digital input and output, available for terminal versions only

The digital input is active (high level) when the applied voltage signal exceeds the threshold of 10V.

5.15

Q.series XE A109: Connecting I/O and Outputs

The Q.series XE A109 has four electrically isolated analog outputs, four digital inputs and four digital outputs. Pin assignments for the connector strips are *not* identical. The plug number is specified in the following. The connection terminals have numbers for identifying the connections.

The designations 0 V and +V designate the (external) supply voltage connections while NC indicates “Not Connected”. Analog ground (-) and (external) supply voltage are electrically isolated in the module.

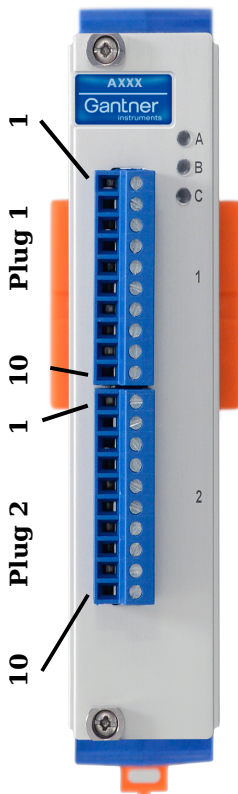

- | | |
|----|---------------------|
| 1 | +V |
| 2 | D _{Out} 1 |
| 3 | D _{Out} 2 |
| 4 | D _{Out} 3 |
| 5 | D _{Out} 4 |
| 6 | D _{In} 1 |
| 7 | D _{In} 2 |
| 8 | D _{In} 3 |
| 9 | D _{In} 4 |
| 10 | 0V |
| | |
| 1 | NC |
| 2 | NC |
| 3 | A _{Out} 1+ |
| 4 | A _{Out} 1- |
| 5 | A _{Out} 2+ |
| 6 | A _{Out} 2- |
| 7 | A _{Out} 3+ |
| 8 | A _{Out} 3- |
| 9 | A _{Out} 4+ |
| 10 | A _{Out} 4- |

Plug 1, Digital Inputs and Outputs

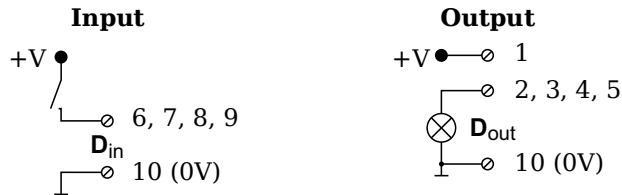

***Input:** Threshold can be programmed as TTL or 10V

***Output:** +V must be between 12V and 30V

Plug 2, Analog Outputs

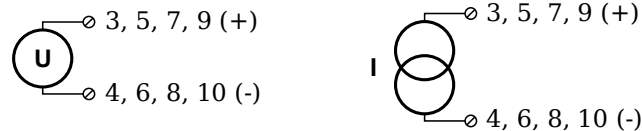

Fig. 5-59 Pin assignments for Q.series XE A109

5.15.1

Digital Input and Output, Terminal 1 Only

Four digital inputs and four digital outputs are available on the Q.series XE A109 via Terminal 1 only. Due to channel-to-channel electrical isolation, you must connect digital inputs to 0V and digital outputs to the supply voltage (+V).

The digital input is active (high level) when the applied voltage signal exceeds the programmable threshold.



Fig. 5-60 A109, terminal wiring configurations for digital input and output, available via Terminal 1 only

The total possible combinations of contact assignments for digital inputs using the Q.series XE A109 are shown in the following table; you may also refer to the block diagrams for the Q.series XE D101 module.

6	7	8	9
status	status	status	status
status	status	2-channel signal ¹⁾	
2-channel signal ¹⁾		2-channel signal ¹⁾	
4-channel signal ²⁾			

- 1) e.g. counter with additional input for counting direction, 2-phase counter signal or frequency measurement with direction detection (torque transducers)
- 2) e.g. counter with additional inputs for counting direction, zero reference and reset/enable for zero reference

5.15.2

Analog Output, Terminal 2 Only

For analog output, two output configurations are available to you via Terminal 2 only: voltage or current. Select the preferred output variant in *GI.bench* (**Analog output type** field in *Variable settings*).



Fig. 5-61 A109, terminal wiring configurations for analog output of voltage or current, available via Terminal 2 only

5.16

Q.series XE A111 BNC: Connect Sensors

The Q.series XE A111 has four electrically isolated analog inputs. The pin assignment of the two connector strips is identical and the connection terminals have numbers for identifying the connections. A BNC variant of the Q.series XE A111 is also available. The designations NC indicates “Not Connected”. Measurement ground (-) and (external) supply voltage are electrically isolated in the module.

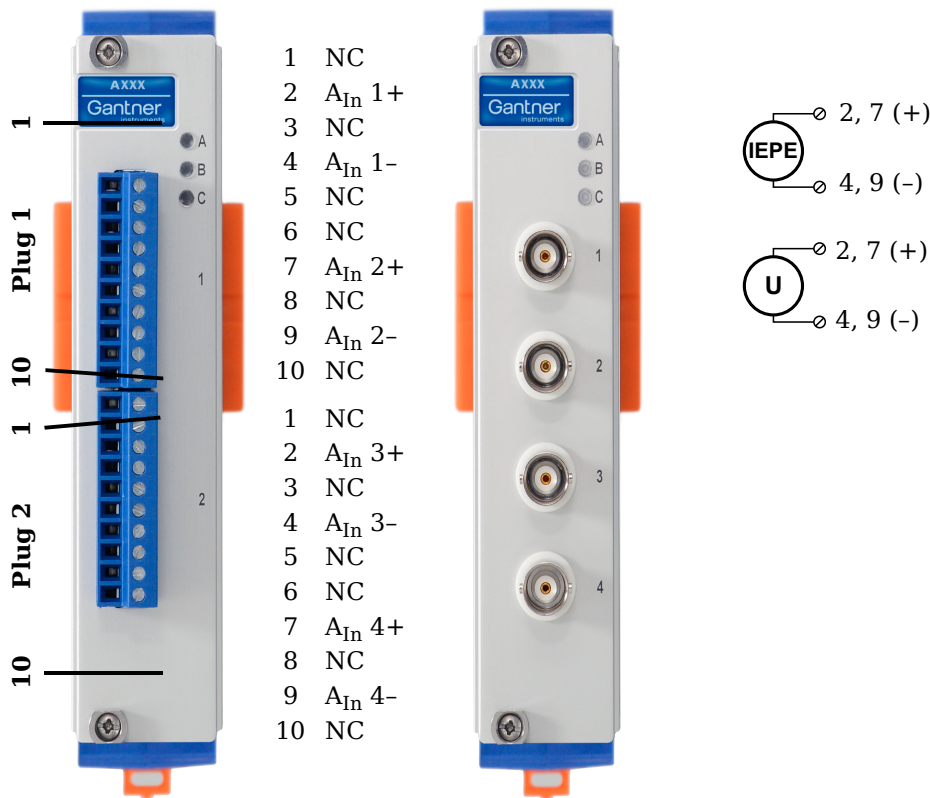

Fig. 5-62 Pin assignments for Q.series XE A111 and BNC variant

i **Tip**

For additional information regarding functional procedures for various measurements, refer to Chapter 7 on page 151.

5.16.1

Voltage

For voltage measurements, you can connect signals of up to ±10V.

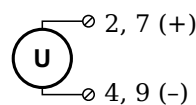

Fig. 5-63 A111, wiring configurations for measurement of voltage

! IMPORTANT

Attempting to measure voltages which exceed the admissible limitations will produce incorrect measurement data as inputs are protected against overvoltage and will therefore limit the input voltage to prevent damage.

5.16.2**IEPE/ICP®**

For IEPE/ICP® measurements, the connected sensor is provided a current supply of 4.5mA from the Q.series XE A111 module.

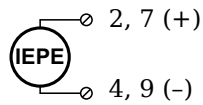

Fig. 5-64 A111, wiring configurations for measurement with IEPE or ICP® sensors

5.17

Q.series XE A116: Connecting Sensors

The Q.series XE A116 has eight analog inputs. We recommend that either the Q.series XE Connection Terminal A116 (Fig. 5-66) or the Cable A116 (Fig. 5-67) used with free ends for connection.

The measurement ground channels (-) are electrically isolated from the (external) supply voltage and the connection terminal.

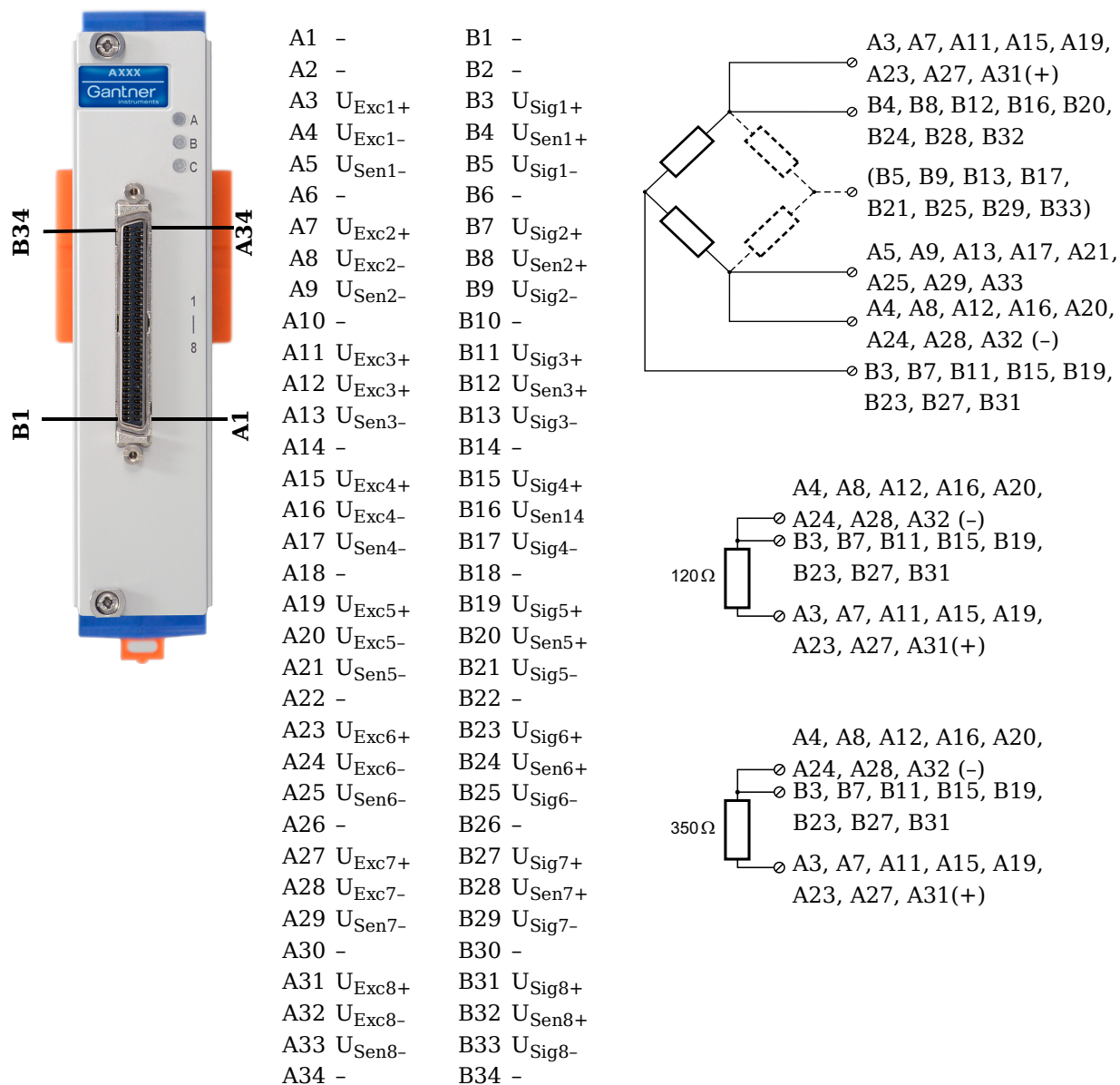

Fig. 5-65 Pin assignments for Q.series XE A116

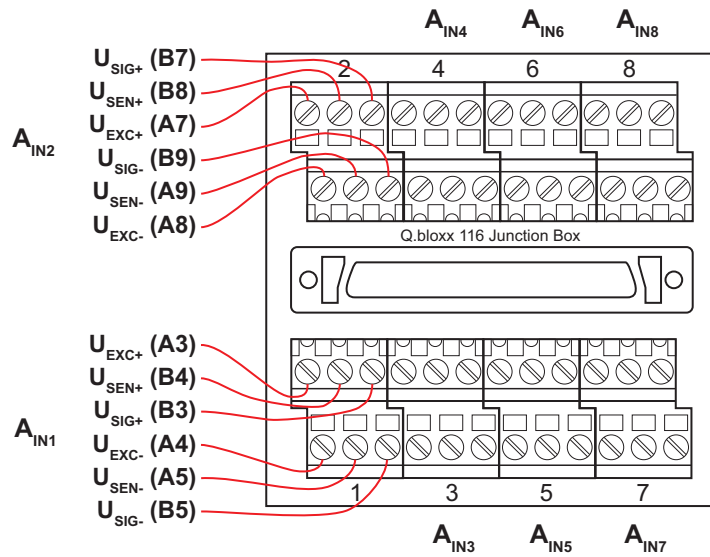

Fig. 5-66 Termination assignments for the Q.series XE Connection Terminal CT A116

Assignment of the cable cores for a cable termination with free ends Cable A116:

Input/ cable bundle	Pairing	Cable color	Sensor connection	Socket connection
1	Pair 1	Light brown	U_{Exc+}	A3
		Light brown/red	U_{Exc-}	A4
	Pair 2	Light green	U_{Sen+}	B4
		Light green/black	U_{Sen-}	A5
	Pair 3	White	U_{Sig+}	B3
		White/black	U_{Sig-}	B5
2	Pair 1	Red/white	U_{Exc+}	A7
		Red/blue	U_{Exc-}	A8
	Pair 2	Yellow/red	U_{Sen+}	B8
		Yellow/blue	U_{Sen-}	A9
	Pair 3	Grey/red	U_{Sig+}	B7
		Grey/blue	U_{Sig-}	B9

Input/ cable bundle	Pairing	Cable color	Sensor connection	Socket connection
3	Pair 1	Blue	U_{Exc+}	A11
		Blue/white	U_{Exc-}	A12
	Pair 2	Pink/red	U_{Sen+}	B12
		Pink/blue	U_{Sen-}	A13
	Pair 3	Light green/yellow	U_{Sig+}	B11
		Light green/green	U_{Sig-}	B13
4	Pair 1	Green/white	U_{Exc+}	A15
		Light green/white	U_{Exc-}	A16
	Pair 2	Light blue/blue	U_{Sen+}	B16
		Light blue/red	U_{Sen-}	A17
	Pair 3	Black	U_{Sig+}	B15
		Black/white	U_{Sig-}	B17
5	Pair 1	Pink	U_{Exc+}	A19
		Pink/black	U_{Exc-}	A20
	Pair 2	Orange/white	U_{Sen+}	B20
		Grey/white	U_{Sen-}	A21
	Pair 3	White/red	U_{Sig+}	B19
		White/blue	U_{Sig-}	B21
6	Pair 1	Light green/red	U_{Exc+}	A23
		Green/blue	U_{Exc-}	A24
	Pair 2	Red	U_{Sen+}	B24
		Red/black	U_{Sen-}	A25
	Pair 3	Purple	U_{Sig+}	B23
		Purple/white	U_{Sig-}	B25

Input/ cable bundle	Pairing	Cable color	Sensor connection	Socket connection
7	Pair 1	Green	U_{Exc+}	A27
		Green/black	U_{Exc-}	A28
	Pair 2	Light blue/green	U_{Sen+}	B28
		Light blue/yellow	U_{Sen-}	A29
	Pair 3	Light yellow	U_{Sig+}	B27
		Light yellow/red	U_{Sig-}	B29
8	Pair 1	Grey	U_{Exc+}	A31
		Grey/black	U_{Exc-}	A32
	Pair 2	White/yellow	U_{Sen+}	B32
		White/green	U_{Sen-}	A33
	Pair 3	Brown	U_{Sig+}	B31
		Brown/white	U_{Sig-}	B33

Fig. 5-67 Assignments while using Cable A116 with flying leads

i Tip

For additional information regarding functional procedures for various measurements, refer to Chapter 7 on page 151.

5.17.1

Full and Half-bridge Transducer

For resistive *full bridge* (strain gage) measurements, six signal connections to the Q.series XE A116 are necessary per channel; the configurations are shown in the diagram below. If you are not utilizing a sensor with sensing leads, you must specify this during module configuration in *GI.bench* (**Analog input type** in settings). In this case, the U_{Sen} inputs remain open. With half bridges the side drawn in dashes and the U_{Sig-} connection are omitted.

For resistive *half bridge* (strain gage) measurements, the dotted sides and connection U_{Sig-} shown in the diagram below are omitted. Internal 120W and 350W bridge completion resistors are available per channel and selectable in *GI.bench* in the **Analog input type** field in *Variable settings*.

The bridge excitation voltage provided by the Q.series XE A116 module is $2V_{DC}$. There is also a bridge excitation voltage of $4V_{DC}$ available for 350Ω sensors. In *Gl.bench*, you can specify the supply voltage in the **Analog input type** field in *Variable settings*.

The Q.series XE A116 also possesses integrated $100k\Omega$ shunt resistors that can be activated per channel. In *Gl.bench*, you can activate the shunt resistance per channel in the **Zero/Tare/Shunt** tab in *Variable settings*. For the activation of the integrated $100k\Omega$ shunt resistors refer to Section 5.17.3.

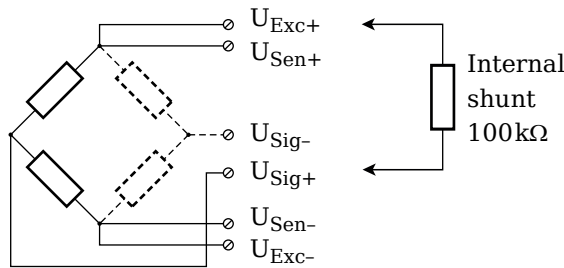

Input 1	
U_{Exc+}	A3
U_{Exc-}	A4
U_{Sen+}	B4
U_{Sen-}	A5
U_{Sig+}	B3
U_{Sig-}	B5

Input 2	
U_{Exc+}	A7
U_{Exc-}	A8
U_{Sen+}	B8
U_{Sen-}	A9
U_{Sig+}	B8
U_{Sig-}	B9

Input 3	
U_{Exc+}	A11
U_{Exc-}	A12
U_{Sen+}	B12
U_{Sen-}	A13
U_{Sig+}	B11
U_{Sig-}	B13

Input 4	
U_{Exc+}	A15
U_{Exc-}	A16
U_{Sen+}	B16
U_{Sen-}	A17
U_{Sig+}	B15
U_{Sig-}	B17

Input 5	
U_{Exc+}	A19
U_{Exc-}	A20
U_{Sen+}	B20
U_{Sen-}	A21
U_{Sig+}	B19
U_{Sig-}	B21

Input 6	
U_{Exc+}	A23
U_{Exc-}	A24
U_{Sen+}	B24
U_{Sen-}	A25
U_{Sig+}	B23
U_{Sig-}	B25

Input 7	
U_{Exc+}	A27
U_{Exc-}	A28
U_{Sen+}	B28
U_{Sen-}	A29
U_{Sig+}	B27
U_{Sig-}	B29

Input 8	
U_{Exc+}	A31
U_{Exc-}	A32
U_{Sen+}	B32
U_{Sen-}	A33
U_{Sig+}	B31
U_{Sig-}	B33

Fig. 5-68 A116, connection terminal wiring configurations for measurement with full and half bridges, direct connection as bridge completion resistors are integrated into module; U_{SIG} = signal voltage (output signal), U_{SEN} = sense lead, U_{EXC} = excitation voltage

For the Q.series XE A116, a special connection terminal is needed as there is insufficient area on the front of the module for the necessary terminations. Special connection terminal can be obtained under the designation *Q.bloxx CT A116* from Gantner Instruments or your domestic Gantner Instruments Sales and Service location.

The termination assignments for the *Q.bloxx CT A116* can be found in Fig. 5-66, page 71 and for the connecting cable with free ends, see Fig. 5-67, page 73 at the beginning of Section 5.17, *Q.series XE A116: Connecting Sensors*.

i Tip

For additional important information regarding using resistive type transducer measurements, refer to Section 7.1, page 151.

5.17.2

Quarter-bridge Strain Gage

For resistive quarter bridge (strain gage) measurements, up to three signal connections to the Q.series XE A116 are necessary per channel; the configurations are shown in the diagram below.

For the Q.series XE A116, a special connection terminal is needed as there is insufficient area on the front of the module for the necessary terminations. Connection terminal is obtained under the designation *Q.bloxx CT A116* from Gantner Instruments or your domestic Gantner Instruments Sales and Service location.

There is no need for a bridge completion connection terminal as the 120Ω and 350Ω bridge completion resistors are integrated into the module and selectable in *GI.bench* in the **Analog input type** field in *Variable settings*.

The bridge excitation voltage provided by the Q.series XE A116 module is 2V_{DC}. There is also a bridge excitation voltage of 4V_{DC} available for 350Ω sensors. In *GI.bench*, you can specify the supply voltage in the **Analog input type** field in *Variable settings*.

The Q.series XE A116 also possesses integrated 100kΩ shunt resistors that can be activated per channel. In *GI.bench*, you can activate the shunt resistance per channel in the **Zero/Tare/Shunt** tab in *Variable settings*. For the activation of the integrated 100kΩ shunt resistors refer to Section 5.17.3.

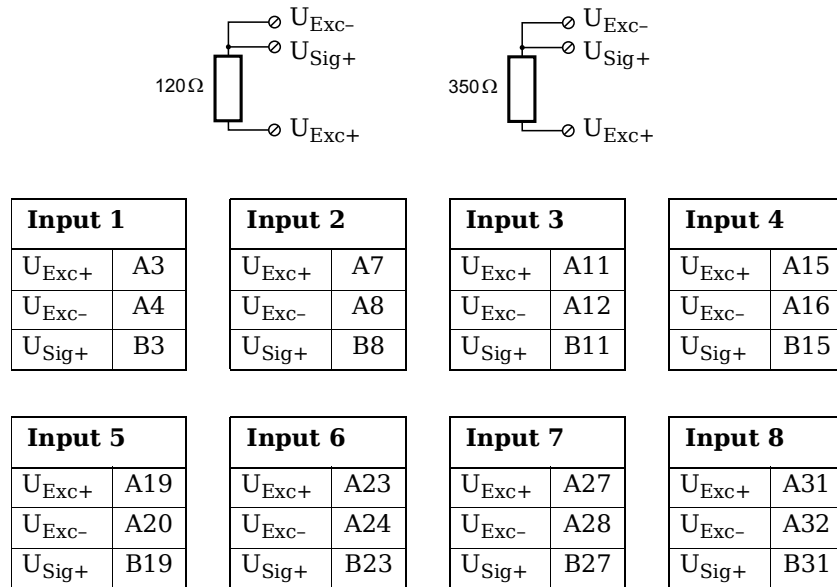

Fig. 5-69 A116, connection terminal wiring configurations for measurement with strain gage quarter bridge using Q.bloxx CT A116, direct connection as bridge completion resistors are integrated into module; U_{SIG} = signal voltage (output signal), U_{EXC} = excitation voltage

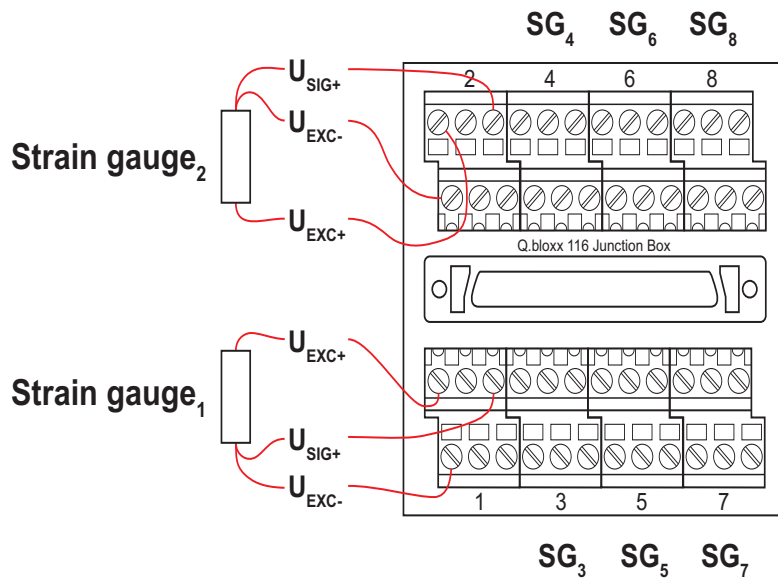

Fig. 5-70 A116, termination assignments for connection terminal Q.series XE CT A116 for measurement with a strain gage quarter bridge

The termination assignments for the Q.bloxx CT A116 can be found in Fig. 5-66, page 71 and for the connecting cable with free ends, see Fig. 5-67, page 73 at the beginning of Section 5.17, Q.series XE A116: Connecting Sensors. For measurement with quarter bridges, only U_{EXC+}, U_{EXC-} and U_{SIG+} are assigned.

For resistive quarter bridge (strain gage) measurements, the Q.series XE A116 utilizes the integrated 120Ω and 350Ω bridge completion resistances to determine the voltage drop over the cable and correct the resultant data accordingly. With this feature, the influence of temperature on the cable (normal three-wire circuit) is compensated for as well as the loss of sensitivity due to cable resistance over cable length.

5.17.3

Activating the Shunt Resistance

The shunted variable must be an analog input. Shunt resistors are only available in modules with bridge inputs.

There are two methods for activating the integrated 100kΩ shunt resistor: either by writing the value 16 to the output PDO (Process Data Object) of the appropriate channel or directly via the SDO (Service Data Object).

For the first method, scan the Q.series XE modules into *GI.bench* via **Import** (refer to Section 6.4, *Communication & Configuring Parameters*, page 112), and open the *Variable settings* window by double clicking on the desired variable in *GI.bench*.

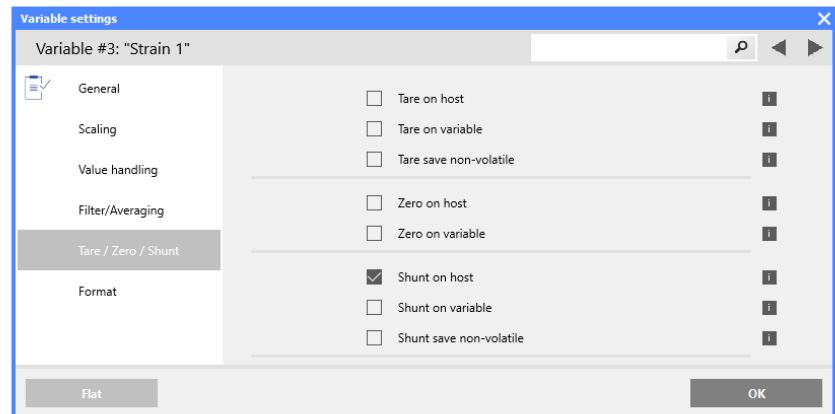

Fig. 5-71 Selecting host activation of shunt within *GI.bench*

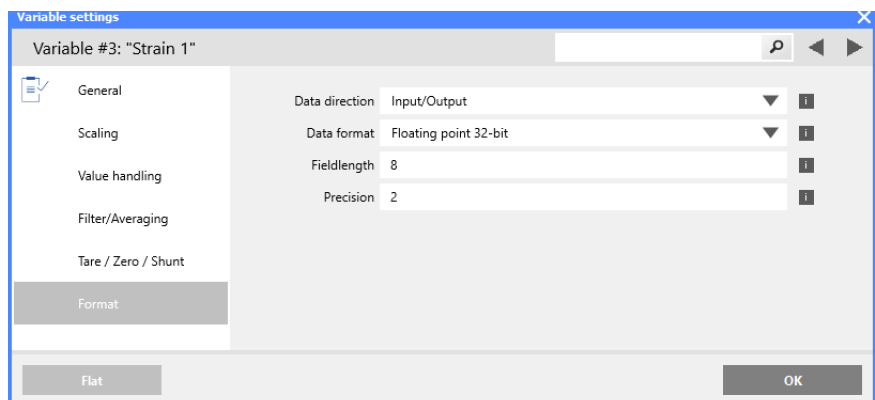

Fig. 5-72 Variable data direction setting in variable *Format* options

You can define **Shunt on host** or **Shunt on variable** in the **Tare/Zero/Shunt** settings. The **Data direction** set in the **Format** options of the analog input (variable) settings must be **Input/Output** if you configure **Shunt on Host** because the analog input needs to check the output PDO of itself. If the 4th bit (16) is activated, then the shunt resistor turns ON.

Alternatively, if you configure **Shunt on variable**, the **Data direction** of the analog input does not need to be **Input/Output** because the analog input only checks the value of the referenced variable. If the value of the referenced variable has the 4th bit (16) activated, then the shunt resistor turns ON.

If both options, **Shunt on host** and **Shunt on variable**, are activated, then both values are checked. If one or both values are 16, then the shunt resistor turns ON.

The second method is to configure the SDO `CfgNullTare 80?3:08` to 1 to turn ON the shunt, or set it to 0 to turn OFF the shunt.

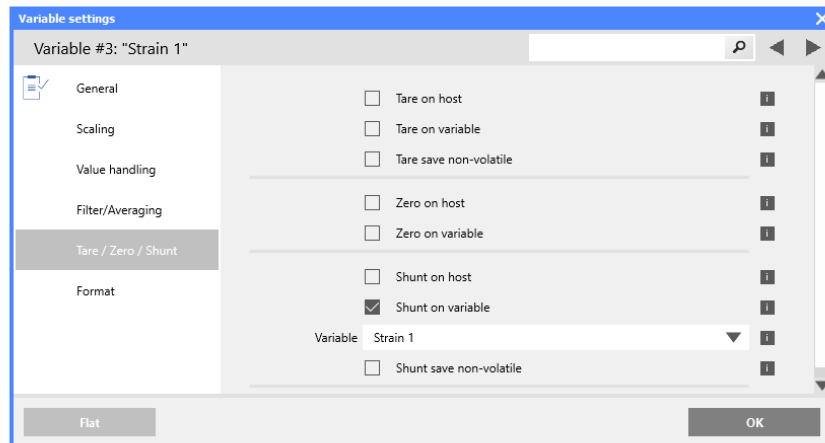

Fig. 5-73 Select a variable to activate the shunt in Tare/Zero/Shunt

Shunt Activation (via host)

In the **Format** tab of the *Variable settings* window, define the **Data direction** as **Input/Output** (Fig. 5-72).

In the **Tare/Zero/Shunt** tab of the *Variable settings* window, check the box for **Shunt on host** (Fig. 5-71).

The master must write the appropriate code to the output-PDO of the influenced variable, i.e., the channel being shunted. GI.bench cannot activate shunts during EtherCAT measurement mode because it is not communicating with the modules. To activate the shunt during EtherCAT measurement mode, define the output-PDO of the influenced (shunted) channel as the value 16.

Refer to Fig. 6-10, page 120 for a list of acceptable codes.

Shunt Activation (via variable)

In the **Tare/Zero/Shunt** tab of *Variable settings* window, check the box for **Shunt on variable** (Fig. 5-73).

An additional field will appear under the **Shunt on variable** check box for selecting the desired (referenced) variable that will activate the shunt resistance (Fig. 5-73).

GI.bench cannot activate the shunt during EtherCAT measurement mode because it is not communicating with the modules. To activate the shunt during EtherCAT measurement mode, define the value of the selected reference variable as 16.

Refer to Fig. 6-10, page 120 for a list of acceptable codes.

5.18

Q.series XE A121: Connecting Sensors

DANGER



Voltage inputs of up to 1200V may be connected to Q.series XE A121, A123, A124, A127 and A128 modules.

Before performing service to or with cables or the modules, ensure to *Lockout/Tagout* any connected power supplies.

The Q.series XE A121 can be used in the categories CAT II up to 1000V and CAT III up to 600V and has two electrically isolated analog inputs. The two 6-pole LEMO connectors are identical and their pinouts can be seen in the diagram below.

Measurement ground (-) and the (module) supply voltage are electrically isolated in the module.

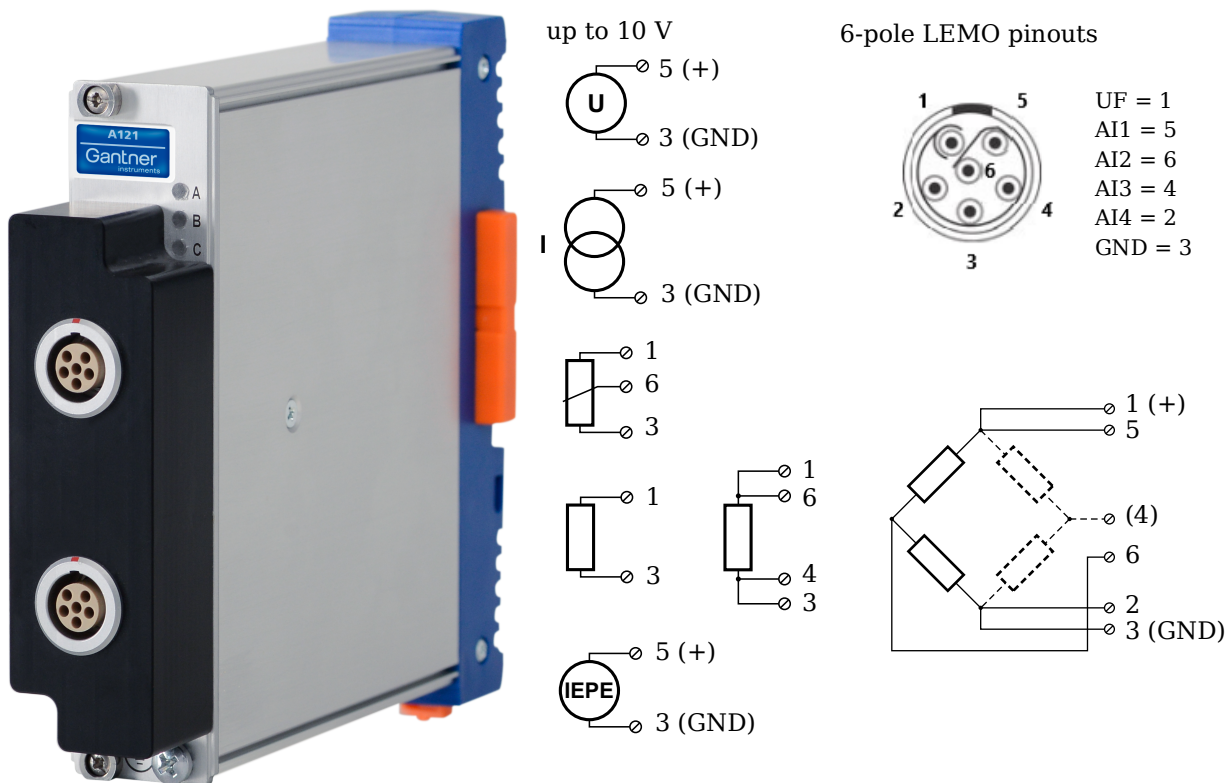

Fig. 5-74 LEMO connector assignments for the Q.series XE A121

5.18.1

Voltage

For voltage measurements, connection is the same regardless of the level of voltages measured: up to $\pm 10V$, $\pm 1V$, and $\pm 100mV$. You can specify the data range while configuring the channel using *GI.bench* (**Hardware defined** or **Maximum** and **Minimum** fields in *Value handling* settings). The voltage level (potential) of the connected signal may be up to $1200V_{DC}$.

! IMPORTANT

Attempting to measure voltages that exceed admissible limits will produce incorrect measurement data as inputs are protected against overvoltage and limit input voltage to prevent damage.

Voltages up to 10V

Fig. 5-75 A121, measurement of voltage

5.18.2**Current**

For current measurements, an internal shunt resistance of 50Ω is integrated into the Q.series X A121 module. The internal shunt resistor will facilitate the measurement of currents up to 25mA.

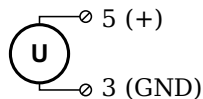
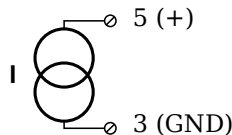

Fig. 5-76 A121, measurement of current

5.18.3**Potentiometer**

For potentiometer measurements, resistances between $1\text{ k}\Omega$ and $10\text{ k}\Omega$ can be connected using a three-wire configuration.

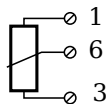

Fig. 5-77 A121, measurement with potentiometers

5.18.4**Resistance, Pt100, Pt1000**

For resistance type and RTD (Pt100/Pt1000) measurements, you may connect sensors using either a two-wire or four-wire configuration. You can specify the type of configuration you wish to use while configuring the channel within *GI.bench* (**Analog input type** in *General* settings).

2-wire circuit**4-wire circuit**

Fig. 5-78 A121, measurement with resistance and Pt100/Pt1000

i Tip

Information regarding transducers and cables with sensing leads can be found in Chapter 7.1 on page 151.

5.18.5

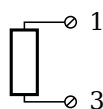
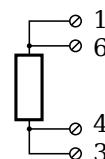
Full and Half-bridge Transducer

For resistive *full-bridge* (strain gage) measurements, all connections to the Q.series XE A121 shown in the diagram below are necessary. If you are not utilizing a sensor with sensing leads, you must specify this during module configuration in *GI.bench* (**Analog input type** in *General* settings). In this case, inputs 4 and 7 remain open in the diagram below.

For resistive *half-bridge* (strain gage) measurements, the dotted sides and connection 6 shown in the diagram below are omitted. The bridge excitation voltage provided by Q.series XE A121 modules is 2.5V.

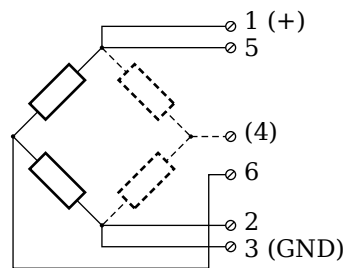

Fig. 5-79 A121, measurement with full- and half-bridges

i Tip

Information regarding transducers and cables with sensing leads can be found in Chapter 7.1 on page 151.

5.18.6

IEPE/ICP®

For IEPE/ICP® measurements, the connected sensor is provided a current supply of 4 mA from the Q.series XE A121 module.

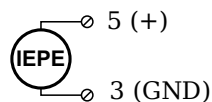

Fig. 5-80 A121, measurement with IEPE or ICP® sensors

5.19

Q.series XE A123: Connecting Sensors

DANGER

Voltage inputs of up to 1200V may be connected to Q.series XE A121, A123, A124, A127 and A128 modules.

Before performing service to or with cables or the modules, ensure to *Lockout/Tagout* any connected power supplies.

The Q.series XE A123 can be used in the categories CAT II up to 1000V and CAT III up to 600V and has four electrically isolated analog inputs. You will find multiple connection assignments listed in sequence in the circuit diagrams, i.e., each connection listed second in sequence belongs to the same sensor connection. Measurement ground (-) and the (module) supply voltage are electrically isolated in the module. The front connectors for the A123 module are security banana, i.e., it is recommended to use cables that also use security banana plugs.

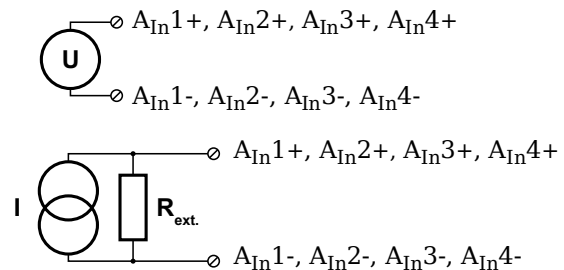
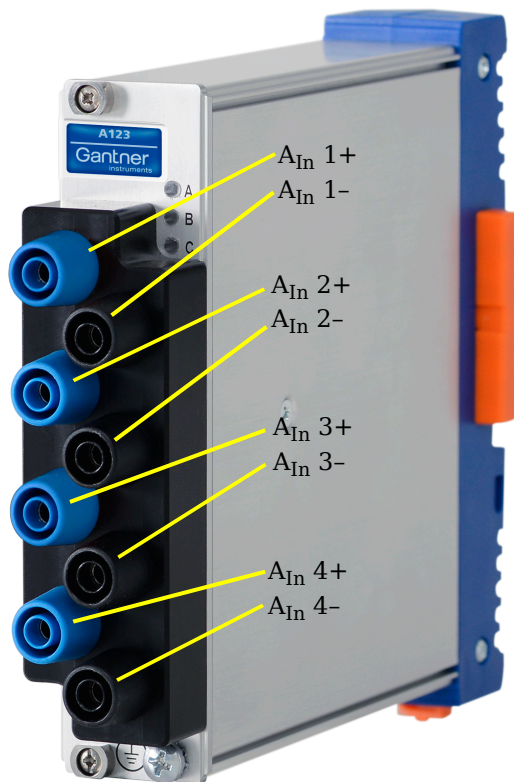

Fig. 5-81 Connection assignments for the Q.series XE A123

5.19.1

Voltage

For voltage measurements, you can connect signals of up to $\pm 10\text{V}$. The voltage level (potential) of the connected signal may be up to 1200V_{DC} .

! IMPORTANT

Attempting to measure voltages which exceed the admissible limitations will produce incorrect measurement data as inputs are protected against overvoltage and will therefore limit the input voltage to prevent damage.

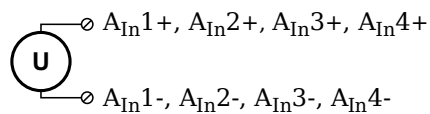

Fig. 5-82 A123, configuration for measurement of voltage using non-terminal version of Q.series XE A123

You need an (external) shunt resistance for the current measurement, refer also to Section 7.3, page 158.

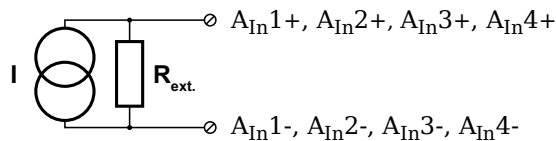

Fig. 5-83 A123, configuration for measurement of current using non-terminal version of Q.series XE A123 and an external shunt resistance

5.20

Q.series XE A124: Connecting Sensors

⚠ DANGER

Voltage inputs of up to 1200V may be connected to Q.series XE A121, A123, A124, A127 and A128 modules.

Before performing service to or with cables or the modules, ensure to *Lockout/Tagout* any connected power supplies.

The Q.series XE A124 can be used in the categories CAT II up to 1000V and CAT III up to 600V and has four electrically isolated analog inputs for thermocouples. You will find multiple connection assignments listed in sequence in the circuit diagrams, i.e., each connection listed second in sequence belongs to the same sensor connection.

Measurement ground (-) and the (module) supply voltage are electrically isolated in the module. The plugs for the A124 module are 2-way plugs with push-in spring technology, i.e. you can insert a solid wire or a fine-stranded wire with a wire-end sleeve directly without screwing (max. 1.5 mm²). The plugs are permanently joined to the housing and cannot be removed. With a screwdriver press on the white opener to remove the connection.



Fig. 5-84 Pin assignments for Q.series XE A124

i Tip

Information regarding transducers and cables with sensing leads can be found in Chapter 7.1 on page 151.

5.20.1

Voltage

For voltage measurements, you can connect signals of up to $\pm 80\text{mV}$. The voltage level (potential) of the connected signal may be up to 1200V_{DC} .

! IMPORTANT

Attempting to measure voltages which exceed the admissible limitations will produce incorrect measurement data as inputs are protected against overvoltage and will therefore limit the input voltage to prevent damage.

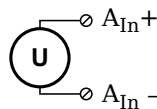

Fig. 5-85 A124, configuration for measurement of voltage using non-terminal version of Q.series XE A124

5.20.2

Thermocouple

For thermocouple measurements with *internal* cold junction compensation, you can connect thermocouples directly to the Q.series XE A124 as the comparative measuring points (cold junction compensation) are integrated into the module terminations. Alternatively, for thermocouple measurements with *external* cold junction compensation, you can use two thermocouples per temperature measurement or a reference temperature source.

You may connect the following types of thermocouples to the Q.series XE A124 module: B, E, J, K, L, N, R, S, T and U.

i Tip

You can find additional information regarding the necessity of a comparative measuring point for thermocouple measurements as well as additional information on thermocouple measurements with a reference temperature source in Section 7.4, *Measurements with Thermocouples*, page 159.

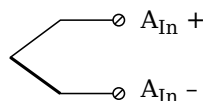

Fig. 5-86 A124, configuration for measurement with thermocouple using non-terminal version of Q.series XE A124

5.21

Q.series XE A127: Connecting Sensors

DANGER

Voltage inputs of up to 1200V may be connected to Q.series XE A121, A123, A124, A127 and A128 modules.

Before performing service to or with cables or the modules, ensure to *Lockout/Tagout* any connected power supplies.

The Q.series XE A127 can be used in the categories CAT II up to 1000V and CAT III up to 600V and has four electrically isolated analog inputs. You will find multiple connection assignments listed in sequence in the circuit diagrams, i.e., each connection listed second in sequence belongs to the same sensor connection. Measurement ground (-) and the (module) supply voltage are electrically isolated in the module. The front connectors for the A127 module are security banana, i.e., it is recommended to use cables that also use security banana plugs.

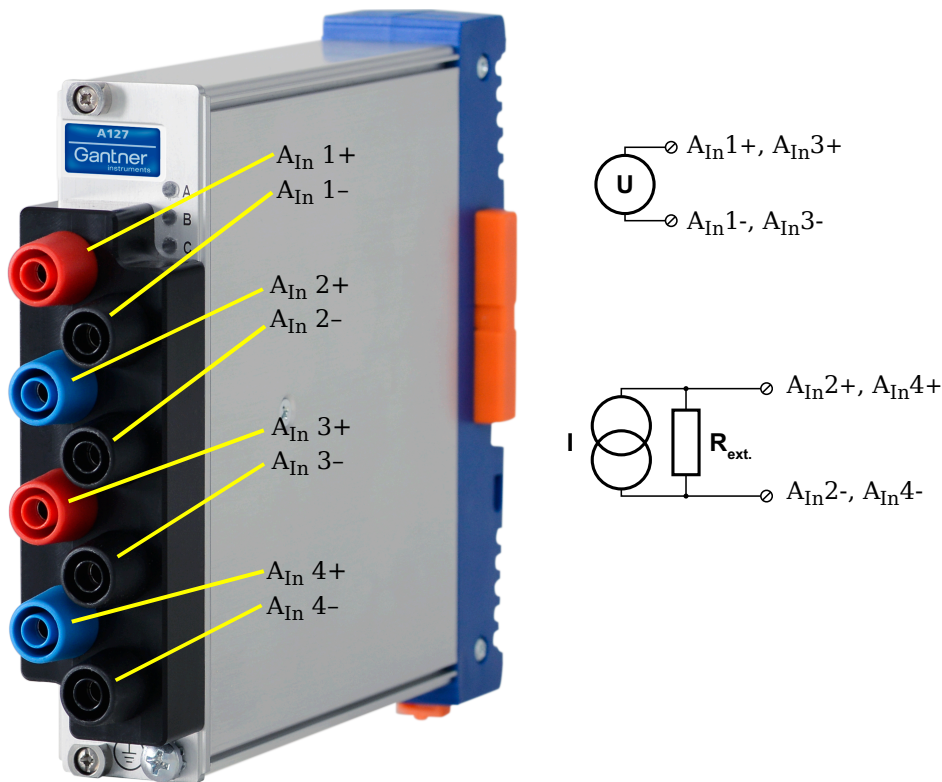

Fig. 5-87 Connection assignments for the Q.series XE A127

i Tip

Information regarding transducers and cables with sensing leads can be found in Chapter 7.1 on page 151.

5.21.1

Voltage

For voltage measurements, you can connect signals of up to $\pm 1200\text{V}$. There are various hardware defined input voltage ranges from $\pm 40\text{V}_{\text{DC}}$ to $\pm 1200\text{V}_{\text{DC}}$. You can specify the data range while configuring the channel in *GI.bench* (**Hardware defined or Maximum and Minimum fields** in *Value handling* settings). The voltage level (potential) of the connected signal may be up to 1200V_{DC} .

NOTICE

Attempting to measure voltages which exceed 1200V_{DC} may damage the Q.series XE A127 module.

Every Q.series XE A127 module is factory tested at 5kV_{DC} for a duration of one minute. Any longer durations or higher voltage levels can damage the module. In addition, every instance of overvoltage that the Q.series XE A127 is subjected to reduces the service life of the module.

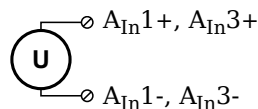

Fig. 5-88 A127, configuration for measurement of voltage using non-terminal version of Q.series XE A127

! IMPORTANT

Attempting to measure voltages which exceed the admissible limitations will produce incorrect measurement data as inputs are protected against overvoltage and will therefore limit the input voltage to prevent damage.

5.21.2

Current**NOTICE**

Incorrectly connecting voltage or current inputs can damage the module and/or the external load resistance. Therefore it is very important to not get the two inputs confused with one another.

Please ensure that high voltage levels are never applied to the current inputs. The voltage drop on current inputs must not exceed $\pm 2.4\text{V}$.

For current measurements, you must use a suitable shunt resistance to determine the current from the voltage drop; refer to Section 7.3, page 158.

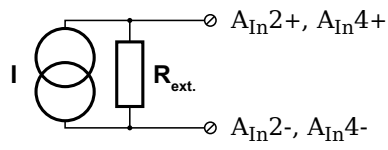

Fig. 5-89 A127, configuration for measurement of current using non-terminal version of Q.series XE A123 and an external shunt resistance

5.22

Q.series XE A128: Connecting sensors

DANGER



Voltage inputs of up to 1200V may be connected to Q.series XE A121, A123, A124, A127 and A128 modules.

Before performing service to or with cables or the modules, ensure to *Lockout/Tagout* any connected power supplies.

The Q.series XE A128 can be used in the categories CAT II up to 1000V and CAT III up to 600V and has four electrically isolated analog inputs. You will find multiple connection assignments listed in sequence in the circuit diagrams, i.e., each connection listed second in sequence belongs to the same sensor connection. Measurement ground (-) and the (module) supply voltage are electrically isolated in the module. The front connectors for the A128 module are security banana, i.e., it is recommended to use cables that also use security banana plugs.

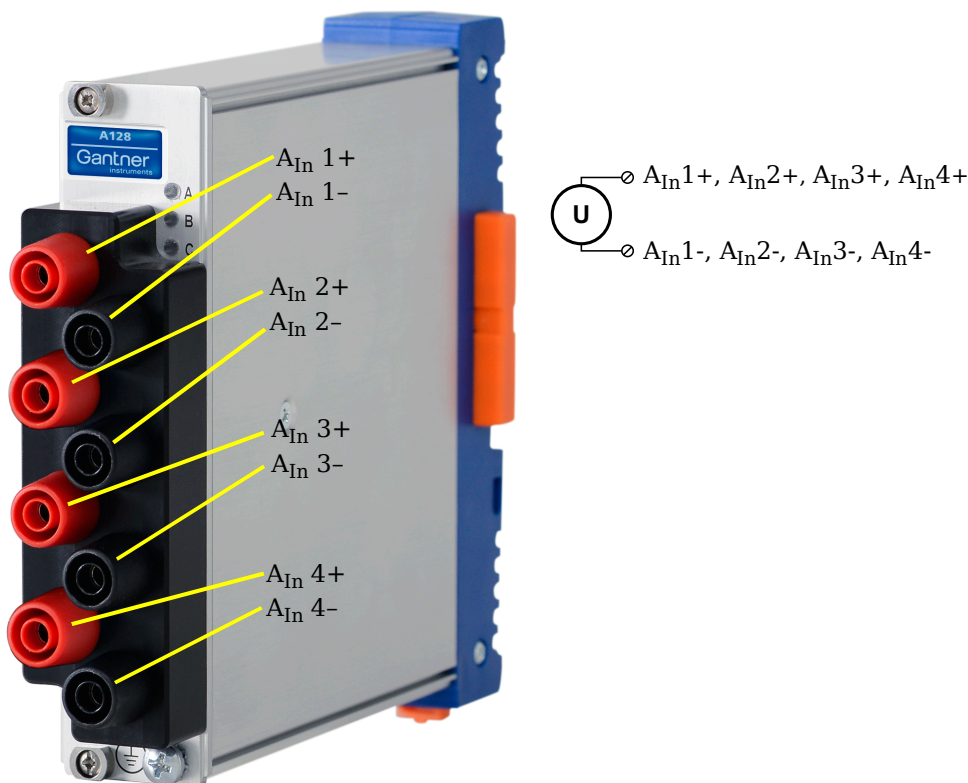

Fig. 5-90 Connection assignments for the Q.series XE A128

i Tip

Information regarding transducers and cables with sensing leads can be found in Chapter 7.1 on page 151.

5.22.1

Voltage

For voltage measurements, you can connect signals of up to $\pm 1200\text{V}$. There are various hardware defined input voltage ranges from $\pm 40\text{V}_{\text{DC}}$ to $\pm 1200\text{V}_{\text{DC}}$. You can specify the data range while configuring the channel in *GI.bench* (**Hardware defined or Maximum and Minimum fields** in *Value handling* settings). The voltage level (potential) of the connected signal may be up to 1200V_{DC} .

NOTICE

Attempting to measure voltages which exceed 1200V_{DC} may damage the Q.series XE A128 module.

Every Q.series XE A128 module is factory tested at 5kV_{DC} for a duration of one minute. Any longer durations or higher voltage levels can damage the module. In addition, every instance of overvoltage that the Q.series XE A128 is subjected to reduces the service life of the module.

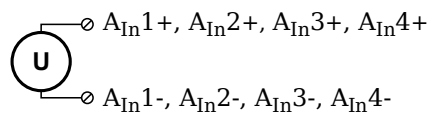

Fig. 5-91 A128, configuration for measurement of voltage using non-terminal version of Q.series XE A128

! IMPORTANT

Attempting to measure voltages which exceed the admissible limitations will produce incorrect measurement data as inputs are protected against overvoltage and will therefore limit the input voltage to prevent damage.

5.23

Q.series XE A141 BNC: Connect Sensors

The Q.series XE A141 has four electrically isolated analog inputs. The connection assignments of the four BNC connectors are identical and have numbers for identifying the connections.

Measurement ground (-) and the module's supply voltage are electrically isolated in the module.

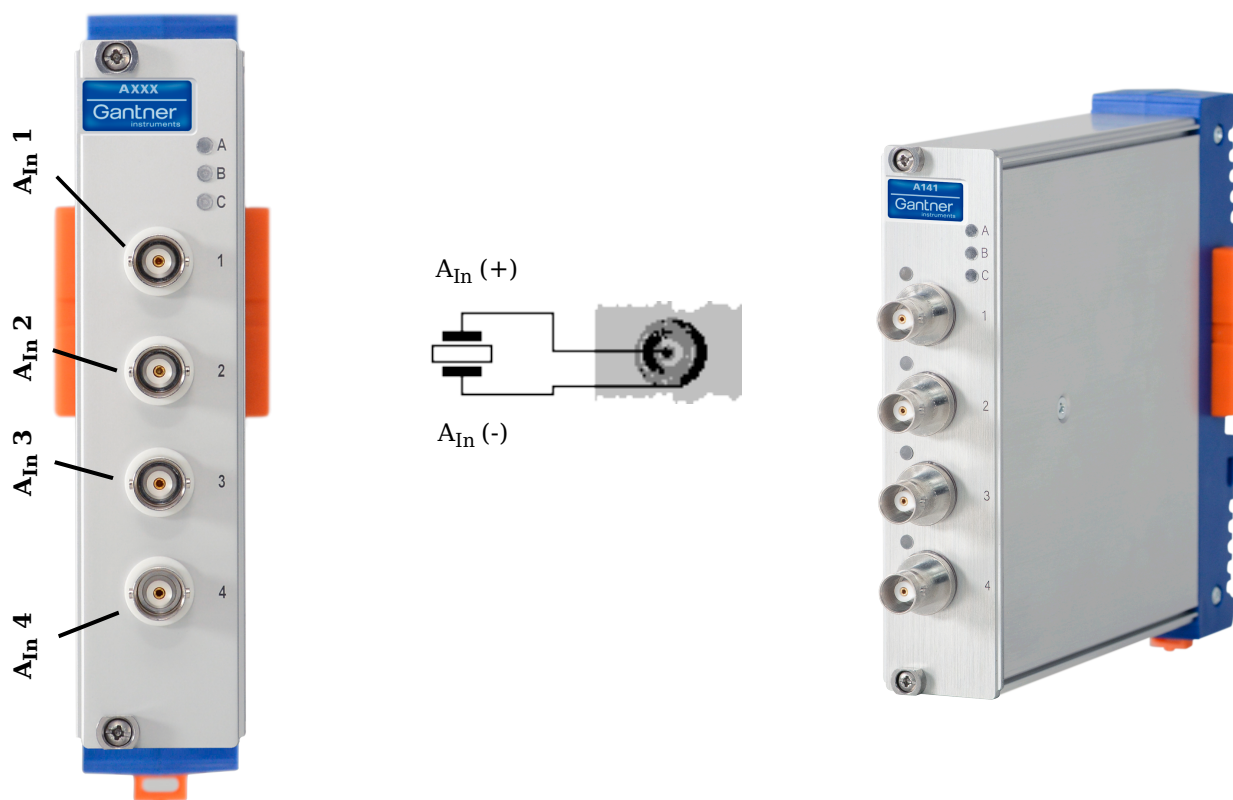

Fig. 5-92 BNC connector assignments for Q.series XE A141 BNC

i Tip

For additional information regarding functional procedures for various measurements, refer to Chapter 7 on page 151.

5.23.1

Piezoelectric, Charge

For piezoelectric measurement of physical quantities, the sensor produces an electric charge which changes in direct proportion with the load acting on it. The Q.series XE A141 module provides universal charge amplification needed for piezoelectric sensors.

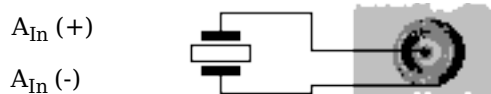
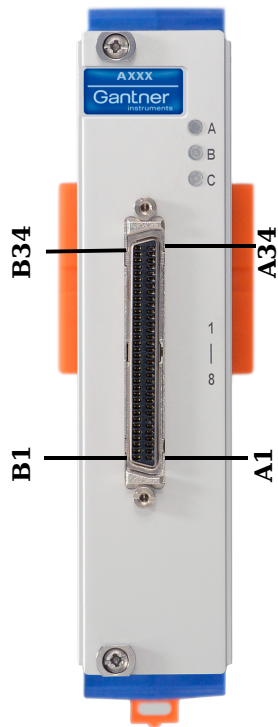

Fig. 5-93 A141, measurement with piezoelectric sensors

5.24

Q.series XE A146: Connecting Sensors

The Q.series XE A146 has sixteen analog inputs for quarter-bridge measurement. It is recommended to use either the 68-pin *Q.bloxx Connection Terminal (CT) A146* (Fig. 5-97, page 98) or *Cable A146* with flying leads (Fig. 5-95, page 96) for connection. All channel connections are electrically isolated from the module supply voltage and the connection terminal. The designation NC signifies “No Connection”.



A1	U _{Sig16}	B1	NC
A2	U _{Exc16+}	B2	U _{Exc16-}
A3	U _{Sig15}	B3	NC
A4	U _{Exc15+}	B4	U _{Exc15-}
A5	U _{Sig14}	B5	NC
A6	U _{Exc14+}	B6	U _{Exc14-}
A7	U _{Sig13}	B7	NC
A8	U _{Exc13+}	B8	U _{Exc13-}
A9	U _{Sig12}	B9	NC
A10	U _{Exc12+}	B10	U _{Exc12-}
A11	U _{Sig11}	B11	NC
A12	U _{Exc11+}	B12	U _{Exc11-}
A13	U _{Sig10}	B13	NC
A14	U _{Exc10+}	B14	U _{Exc10-}
A15	U _{Sig9}	B15	NC
A16	U _{Exc9+}	B16	U _{Exc9-}
A17	NC	B17	NC
A18	NC	B18	NC
A19	U _{Sig8}	B19	NC
A20	U _{Exc8+}	B20	U _{Exc8-}
A21	U _{Sig7}	B21	NC
A22	U _{Exc7+}	B22	U _{Exc7-}
A23	U _{Sig6}	B23	NC
A24	U _{Exc6+}	B24	U _{Exc6-}
A25	U _{Sig5}	B25	NC
A26	U _{Exc5+}	B26	U _{Exc5-}
A27	U _{Sig4}	B27	NC
A28	U _{Exc4+}	B28	U _{Exc4-}
A29	U _{Sig3}	B29	NC
A30	U _{Exc3+}	B30	U _{Exc3-}
A31	U _{Sig2}	B31	NC
A32	U _{Exc2+}	B32	U _{Exc2-}
A33	U _{Sig1}	B33	NC
A34	U _{Exc1+}	B34	U _{Exc1-}

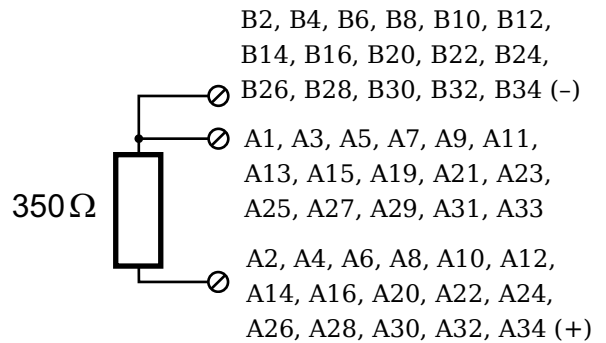

Fig. 5-94 Pin assignments for Q.series XE A146 module

i Tip

For additional information regarding functional procedures for various measurements, refer to Chapter 7 on page 151.

Q.bloxx X Cable A146 with flying leads connection assignments:

Channel	Pairing	Cable color	Sensor connection	Socket connection
16	Pair 1	Light brown	U _{Sig16+}	A1
		Light brown/red	NC	B1
	Pair 2	Light green	U _{Exc16+}	A2
		Light green/black	U _{Exc16-}	B2
15	Pair 1	White	U _{Sig15+}	A3
		White/black	NC	B3
	Pair 2	Red/white	U _{Exc15+}	A4
		Red/blue	U _{Exc15-}	B4
14	Pair 2	Yellow/red	U _{Sig14+}	A5
		Yellow/blue	NC	B5
	Pair 3	Grey/red	U _{Exc14+}	A6
		Grey/blue	U _{Exc14-}	B6
13	Pair 1	Blue	U _{Sig13+}	A7
		Blue/white	NC	B7
	Pair 2	Pink/red	U _{Exc13+}	A8
		Pink/blue	U _{Exc13-}	B8
12	Pair 1	Light green/yellow	U _{Sig12+}	A9
		Light green/green	NC	B9
	Pair 2	Green/white	U _{Exc12+}	A10
		Light green/white	U _{Exc12-}	B10
11	Pair 1	Light blue/blue	U _{Sig11+}	A11
		Light blue/red	NC	B11
	Pair 2	Black	U _{Exc11+}	A12
		Black/white	U _{Exc11-}	B12

Channel	Pairing	Cable color	Sensor connection	Socket connection
10	Pair 1	Pink	$U_{\text{Sig}10+}$	A13
		Pink/black	NC	B13
	Pair 2	Orange/white	$U_{\text{Exc}10+}$	A14
		Grey/white	$U_{\text{Exc}10-}$	B14
9	Pair 1	White/red	$U_{\text{Sig}9+}$	A15
		White/blue	NC	B15
	Pair 2	Light green/red	$U_{\text{Exc}9+}$	A16
		Green/blue	$U_{\text{Exc}9-}$	B16
NC	Pair 1	Red	NC	A17
		Red/black	NC	B17
	Pair 2	Purple	NC	A18
		Purple/white	NC	B18
8	Pair 1	Green	$U_{\text{Sig}8+}$	A19
		Green/black	NC	B19
	Pair 2	Light blue/green	$U_{\text{Exc}8+}$	A20
		Light blue/yellow	$U_{\text{Exc}8-}$	B20
7	Pair 1	Light yellow	$U_{\text{Sig}7+}$	A21
		Light yellow/red	NC	B21
	Pair 2	Grey	$U_{\text{Exc}7+}$	A22
		Grey/black	$U_{\text{Exc}7-}$	B22
6	Pair 1	White/yellow	$U_{\text{Sig}6+}$	A23
		White/green	NC	B23
	Pair 2	Brown	$U_{\text{Exc}6+}$	A24
		Brown/white	$U_{\text{Exc}6-}$	B24
5	Pair 1	Light yellow/green	$U_{\text{Sig}5+}$	A25
		Light yellow/blue	NC	B25
	Pair 2	Yellow	$U_{\text{Exc}5+}$	A26
		Yellow/black	$U_{\text{Exc}5-}$	B26

Channel	Pairing	Cable color	Sensor connection	Socket connection
4	Pair 1	Pink/white	U_{Sig4+}	A27
		Pink/yellow	NC	B27
	Pair 2	Orange	U_{Exc4+}	A28
		Orange/black	U_{Exc4-}	B28
3	Pair 1	Light blue	U_{Sig3+}	A29
		Light blue/black	NC	B29
	Pair 2	Grey/green	U_{Exc3+}	A30
		Grey/yellow	U_{Exc3-}	B30
2	Pair 1	Light yellow/black	U_{Sig2+}	A31
		Yellow/white	NC	B31
	Pair 2	Purple/red	U_{Exc2+}	A32
		Blue/red	U_{Exc2-}	B32
1	Pair 1	Purple/green	U_{Sig1+}	A33
		Purple/blue	NC	B33
	Pair 2	Orange/green	U_{Exc1+}	A34
		Orange/red	U_{Exc1-}	B34

Fig. 5-95 Connection assignments for Cable A146 with flying leads

5.24.1

Quarter-bridge Strain Gage

For resistive quarter-bridge (strain gage) measurements, up to three connections to the Q.series XE A146 are necessary per channel; the configurations are shown in the diagram below.

A special connection terminal is needed due to insufficient area on the front of the Q.series XE A146 module to accommodate all of the necessary terminations. The connection terminal can be obtained under the designation *Q.bloxx CT A146* from your domestic Gantner Instruments Sales and Service location.

There is no need for external bridge completion due to the 350Ω bridge completion resistors integrated in the module.

The bridge excitation voltage provided by the Q.series XE A146 module is $2V_{DC}$.

The Q.series XE A146 possesses integrated 100kΩ shunt resistors that can be activated per channel. In *GI.bench*, you can activate the shunt resistance per channel in the **Zero/Tare/Shunt** tab in *Variable settings*. For the activation of the integrated 100kΩ shunt resistors refer to Section 5.17.3, *Activating the Shunt Resistance*, page 77.

Input 1		Input 2		Input 3		Input 4	
U_{Exc+}	A34	U_{Exc+}	A32	U_{Exc+}	A30	U_{Exc+}	A28
U_{Exc-}	B34	U_{Exc-}	B32	U_{Exc-}	B30	U_{Exc-}	B28
U_{Sig+}	A33	U_{Sig+}	A31	U_{Sig+}	A29	U_{Sig+}	A27

Input 5		Input 6		Input 7		Input 8	
U_{Exc+}	A26	U_{Exc+}	A24	U_{Exc+}	A22	U_{Exc+}	A20
U_{Exc-}	B26	U_{Exc-}	B24	U_{Exc-}	B22	U_{Exc-}	B20
U_{Sig+}	A25	U_{Sig+}	A23	U_{Sig+}	A21	U_{Sig+}	B19

Input 9		Input 10		Input 11		Input 12	
U_{Exc+}	A16	U_{Exc+}	A14	U_{Exc+}	A12	U_{Exc+}	A10
U_{Exc-}	B16	U_{Exc-}	B14	U_{Exc-}	B12	U_{Exc-}	B10
U_{Sig+}	A15	U_{Sig+}	A13	U_{Sig+}	A11	U_{Sig+}	A9

Input 13		Input 14		Input 15		Input 16	
U_{Exc+}	A8	U_{Exc+}	A6	U_{Exc+}	A4	U_{Exc+}	A2
U_{Exc-}	B8	U_{Exc-}	B6	U_{Exc-}	B4	U_{Exc-}	B2
U_{Sig+}	A7	U_{Sig+}	A5	U_{Sig+}	A3	U_{Sig+}	A1

Fig. 5-96 A146, terminal wiring for measurement with strain gage quarter bridge using Q.bloxx CT A146, bridge completion resistors are integrated into module; U_{SIG} = signal voltage (output signal), U_{EXC} = excitation voltage

Q.bloxx CT A146 is shown in Fig. 5-97, page 98 and the assignments for connecting *Cable A146* with free ends can be found in Fig. 5-95, page 96. For measurement with quarter bridges, only U_{Exc+} , U_{Exc-} and U_{Sig+} are assigned.

For resistive quarter-bridge (strain gage) measurements, the Q.series XE A146 utilizes integrated 350Ω bridge completion resistors to determine the voltage drop over the sensor cable and corrects the resultant data accordingly. With this feature, the influence of temperature on the cable (normal three-wire circuit) is compensated for as well as the loss of sensitivity due to cable resistance over cable length.

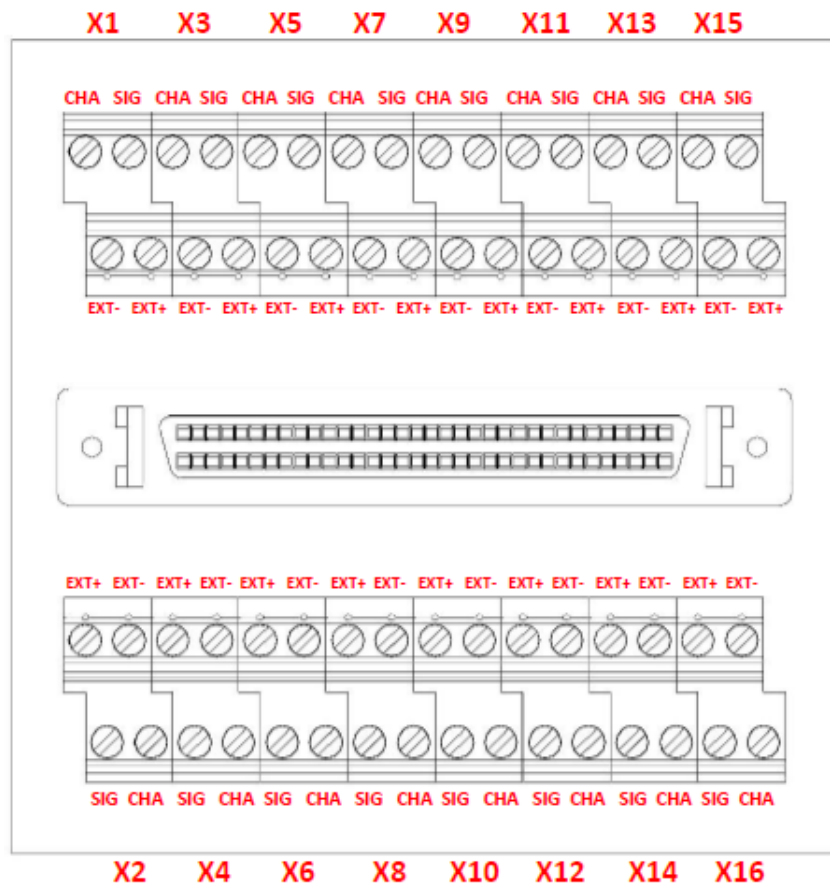

Fig. 5-97 A146, termination assignments for connection terminal Q.series XE CT A146 for measurement with a strain gage quarter bridge

5.25

Q.series XE D101: Connecting I/O

The Q.series XE D101 has eight digital inputs and eight digital outputs. The pin assignment of the two connector strips is identical and the connection terminals have numbers for identifying the connections. You will find the associated figures in each case at the same place in the circuit diagrams, for example each of the figures quoted in the second place belong to one possible connection method. The designations 0 V and +V refer to the (external) supply voltage connections.

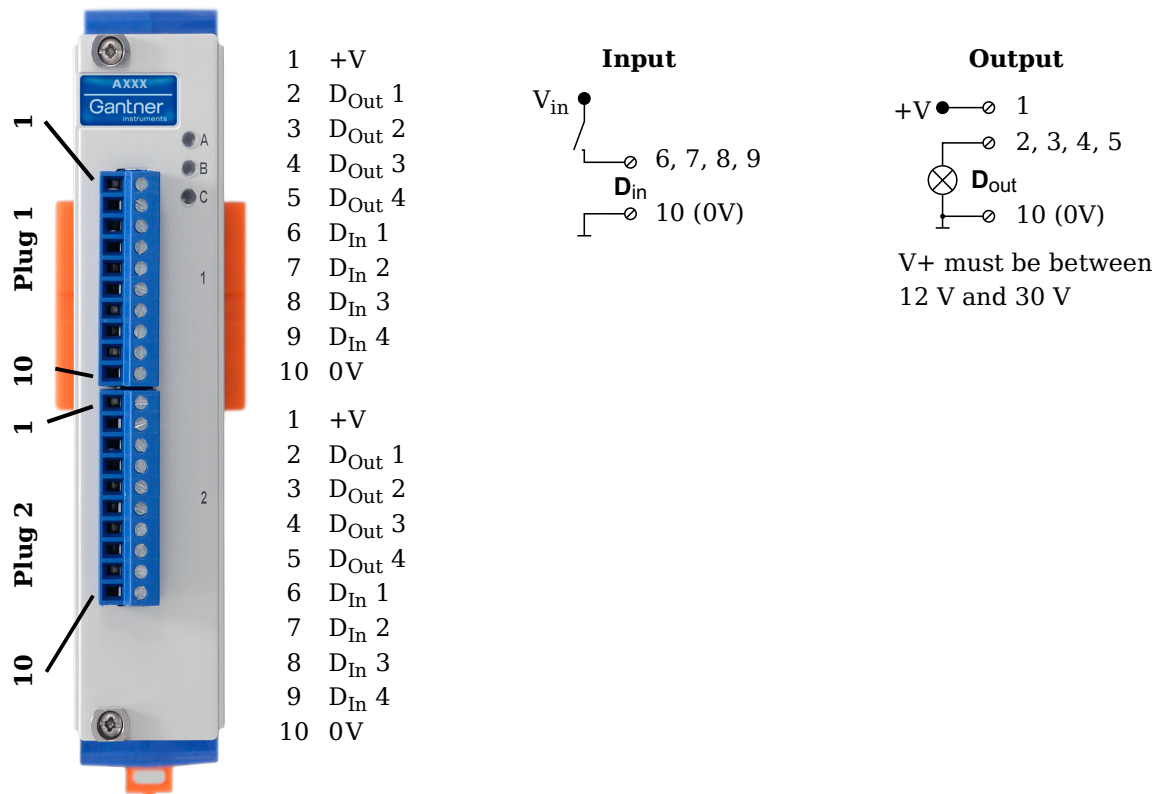

Fig. 5-98 Pin assignments for Q.series XE D101

5.25.1

Digital Input and Output

On each Q.series XE D101 terminal, there are four contacts available for digital inputs and four contacts available for digital outputs. You can use the appropriate function(s) depending on the terminal wiring configurations shown in the following diagram. Due to channel-to-channel electrical isolation, you must connect digital inputs to 0V and digital outputs to the supply voltage (+V).

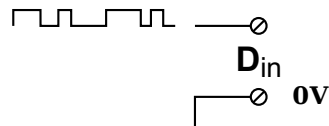

Fig. 5-99 D101, wiring configurations for digital input and output

The digital input is active (high level) when the applied voltage signal exceeds the programmable threshold.

The following block diagrams provide an overview of the possible circuit configurations.

Measurement of status, time, frequency or PWM (Pulse-Width Modulation), 1 signal



Up/down counter or measurement of frequency and direction with static direction signal, 2 signals

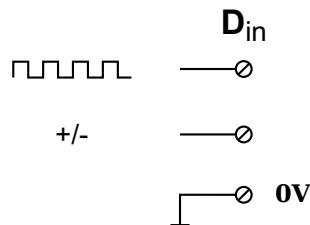

Measurement of frequency and direction or up/down counter with 2-channel frequency signal (90° phase delay)

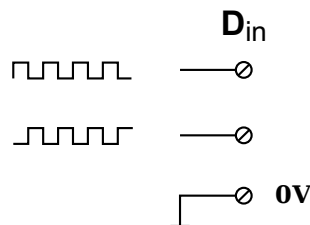

Measurement of frequency and direction or up/down counter with 4-channel frequency signal

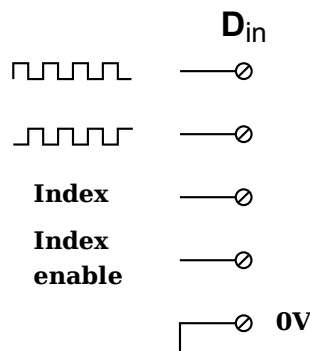

5.26

Q.series XE D104: Connecting Digital Inputs

The Q.series XE D104 has sixteen digital inputs. The pin assignment of the two connector strips is identical and the connection terminals have numbers for identifying the connections. You will find the associated figures in each case at the same place in the circuit diagrams, for example each of the figures quoted in the second place belong to one possible connection method.

The designations 0 V and +V refer to the digital input voltage connections (10V or TTL) while NC indicates “Not Connected”.

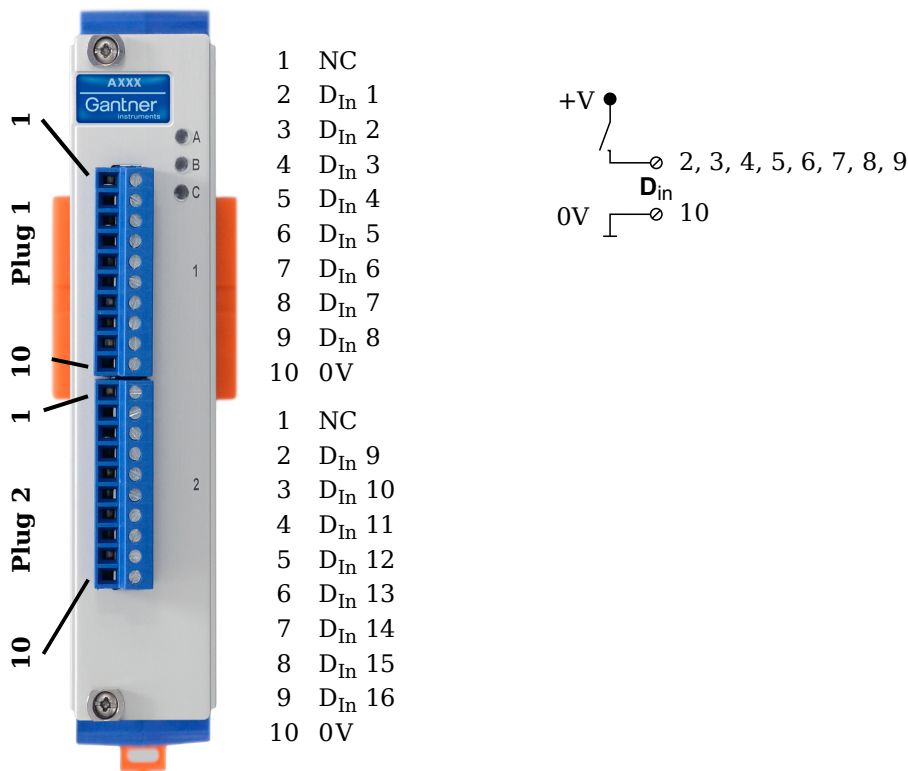

Fig. 5-100 Pin assignments for Q.series XE D104

5.26.1

Digital Input

On each Q.series XE D104 terminal, there are eight contacts available for digital inputs. Due to channel-to-channel electrical isolation, you must connect digital inputs to 0V.

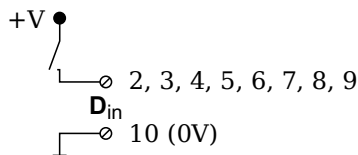

Fig. 5-101 D104, terminal wiring configurations for digital input

The digital input is active (high level) when the applied voltage signal exceeds the programmable threshold, TTL or 10V.

5.27

Q.series XE D105: Connecting Digital Outputs

The Q.series XE D105 has sixteen digital outputs. The pin assignment of the two connector strips is identical and the connection terminals have numbers for identifying the connections. You will find the associated figures in each case at the same place in the circuit diagrams, for example each of the figures quoted in the second place belong to one possible connection method.

The designations 0 V and +V refer to the (external) supply voltage connections.

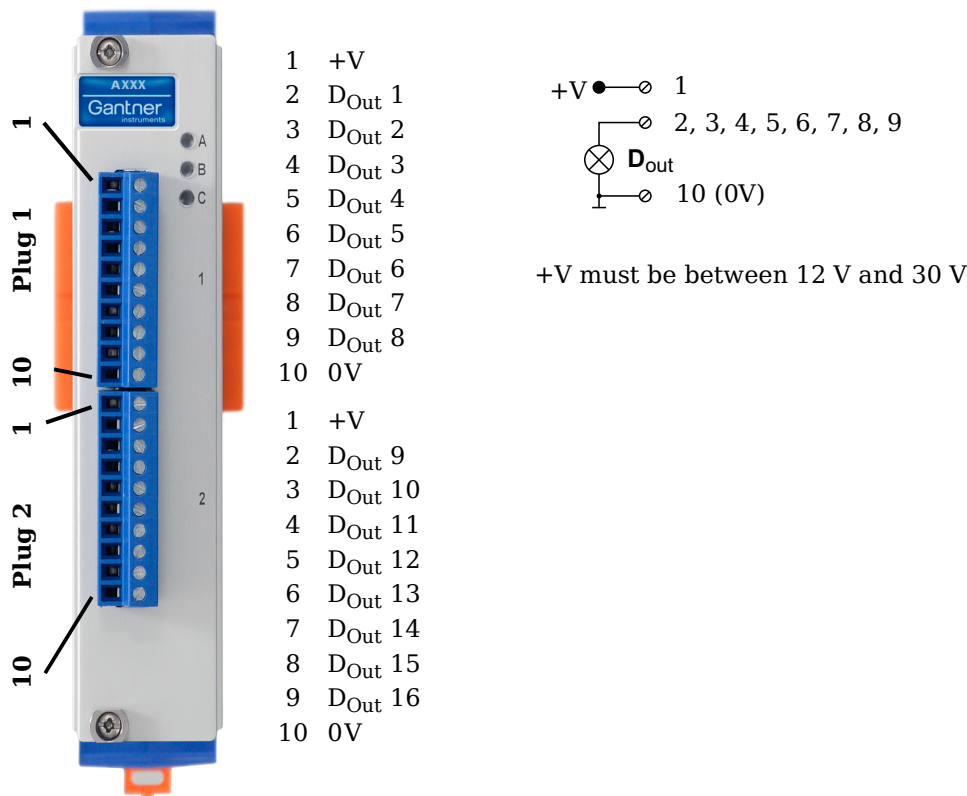

Fig. 5-102 Pin assignments for Q.series XE D105

5.27.1

Digital Output

On each Q.series XE D105 terminal, there are eight contacts available for digital outputs. Due to channel-to-channel electrical isolation, you must connect digital inputs to 0V and digital outputs to the supply voltage (+V).

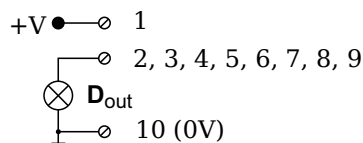

Fig. 5-103 D105, terminal wiring configurations for digital output

5.28

Q.series XE D107: Connecting Digital Inputs

The Q.series XE D107 has six digital inputs. The pin assignment of the two connector strips is identical and the connection terminals have numbers for identifying the connections. You will find the associated figures in each case at the same place in the circuit diagrams, for example each of the figures quoted in the second place belong to one possible connection method.

The designations 0 V (GND) and +V refer to the supply voltage connections for supplying the sensors. NC signifies "No Connection". Both terminals are electrically isolated from one another and from the module supply voltage.

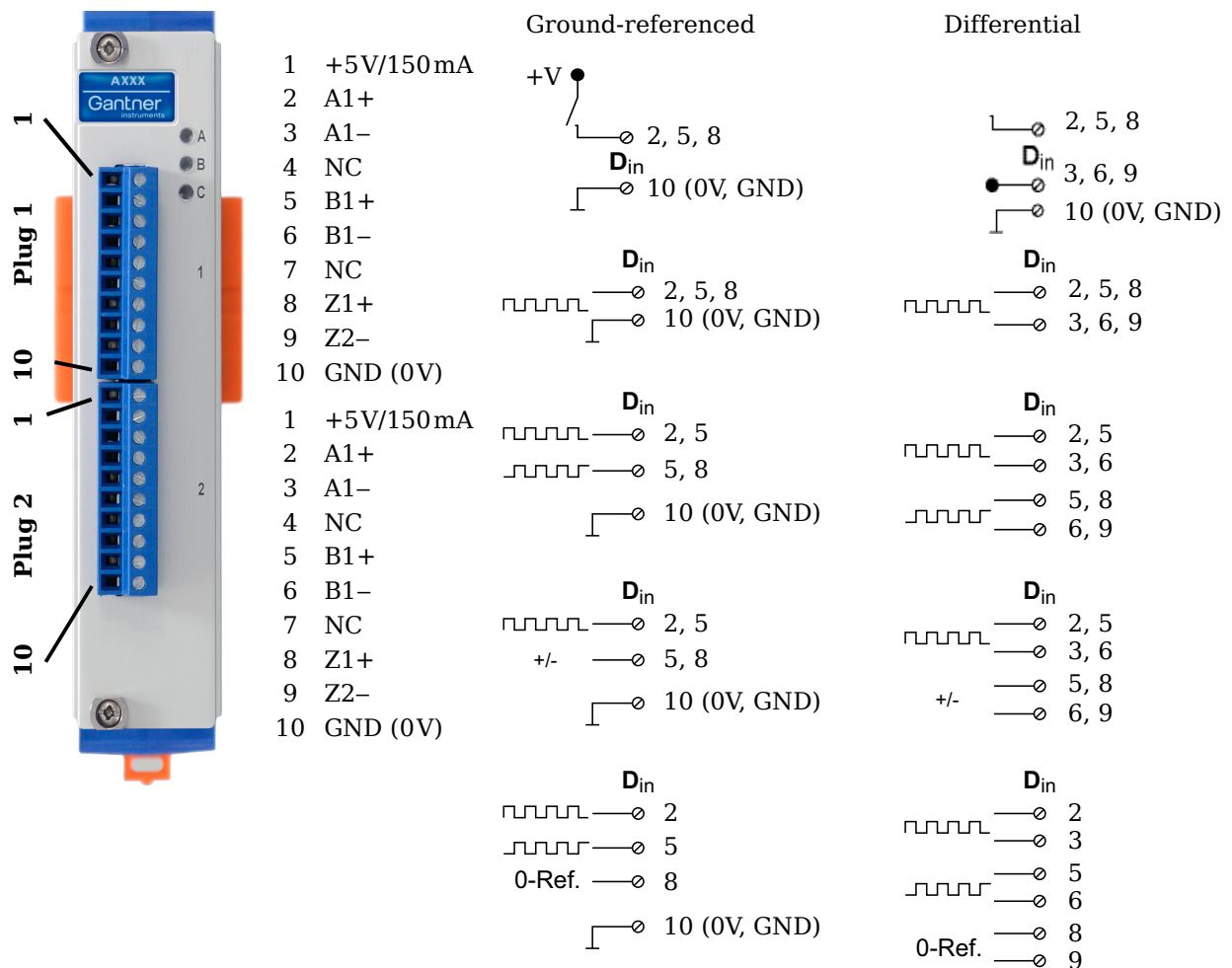

Fig. 5-104 Pin assignments & circuit variants for Q.series XE D107

5.28.1

Digital Input

On each Q.series XE D107 terminal, there are three contacts available for digital inputs. The connected digital inputs can be differential or ground referenced (single-ended). Due to channel-to-channel electrical isolation, you must connect digital inputs to 0V and the supply voltage (+V), even when using differential digital inputs.

The supply voltage (+V) is 5V and maximum 150mA per terminal on the Q.series XE D107.

The digital input is active (high level) when the applied voltage signal exceeds the programmable thresholds. The thresholds can be configured in the *Variable settings* window in *GI.bench* under the **Digital input** tab. For differential measurements, the threshold can be configured as any of 256 steps between $\pm 20V$, otherwise the threshold range is typically between 0V and +26V.

The total possible combinations of contact assignments for digital inputs via Terminal 1 of the Q.series XE D107 are shown in the following table (Dx = Sensor x):

Operating mode	Terminal.Contact						
	1.2 (A1+)	1.3 (A1-)	1.5 (B1+)	1.6 (B1-)	1.8 (Z1+)	1.9 (Z1-)	1.10 (0V)
3 x standard ¹⁾ , differential	D1 ₁₊	D1 ₁₋	D2 ₁₊	D2 ₁₋	D3 ₁₊	D3 ₁₋	GND
3 x standard, single-ended	D1 ₁₊	—	D2 ₁₊	—	D3 ₁₊	—	GND
1 x 2 sensor signals ²⁾ + 1 x standard, differential	D1 ₁₊	D1 ₁₋	D1 ₂₊	D1 ₂₋	D2 ₁₊	D2 ₁₋	GND
1 x 2 sensor signals + 1 x standard, single-ended	D1 ₁₊	—	D1 ₂₊	—	D2 ₁₊	—	GND
1 x 3 sensor signals ³⁾ , dif- ferential	D1 ₁₊	D1 ₁₋	D1 ₂₊	D1 ₂₋	D1 ₃₊	D1 ₃₋	GND
1 x 3 sensor signals, sin- gle-ended	D1 ₁₊	—	D1 ₂₊	—	D1 ₃₊	—	GND

1) e.g. status input, frequency measurement or counter

2) e.g. counter with additional input for counting direction (forwards/reverse counter) or 2-phase counter signals (quadrature counter) or frequency measurement with direction detection (torque transducers)

3) e.g. 2-phase counter signal or angle sensor with additional input for zero reference

The following diagrams are examples of connections of various types of sensors to the Q.series XE D107. For each example, only one sensor and one variant is shown. The connection of a single digital input is not considered in the diagrams (e.g. the sensors in Fig. 5-106 and Fig. 5-107 can be connected at 5/6 and 8/9, and still allow for connections 2/3 which can be an additional standard sensor or digital input). The Q.series XE D107 allows for the mixture of ground-referenced and differential sensor connections on each terminal assuming there is enough room for additional connections to be made.

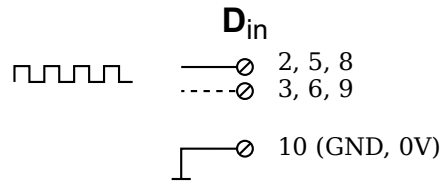

Fig. 5-105 D107, example of sensor with one signal, single-ended or differential input (dotted line)

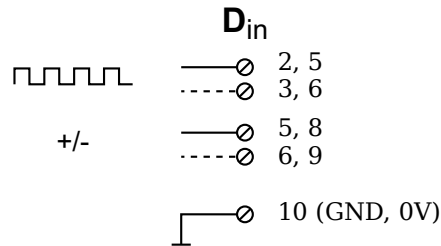

Fig. 5-106 D107, example of sensor with two signals (counting direction), single-ended or differential input (dotted line)

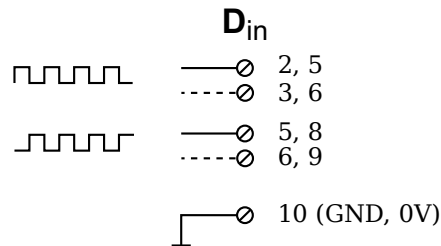

Fig. 5-107 D107, example of sensor with two signals (90° offset), single-ended or differential input (dotted line)

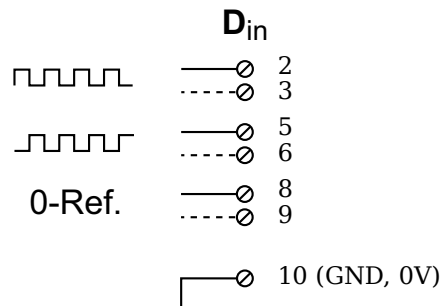

Fig. 5-108 D107, example of sensor with three signals (2 x 90° offset and zero ref.), single-ended or differential input (broken line)

6

System Configuration

Q.series XE system configuration is most easily carried out with the software *GI.bench*. You can also carry out a configuration via an EtherCAT master. With an EtherCAT master, terms are kept short, e.g. **Cfg: Ch1 > MeasTyp** for the selection of sensor type, therefore we recommend configurations are performed with the graphically guided configuration software *GI.bench*.

6.1

EtherCAT Slave Configuration

To add an EtherCAT slave device to the Process Image (Input/Output PDO configuration) of an EtherCAT master, the PDO mapping information of all connected EtherCAT slave devices has to be made available to the EC master.

There are several options to provide this information:

- Read PDO mapping Online via CoE (dynamic PDO config.)
- Read PDO mapping from an ESI file (static PDO config.)
- Setup the EC master PDO configuration manually

Typically EtherCAT slave devices have a fixed PDO configuration. In such case, the EC master could simply read the PDO configuration from an ESI file (static PDO configuration). However, the Q.series XE slave devices do not have a fixed PDO configuration. Therefore it is recommended to use dynamic PDO configuration via CoE (CANopen over EtherCAT).

6.1.1

Dynamic PDO Configuration

Since Gantner Instruments' EtherCAT slave devices have a very flexible configuration, the PDO configuration of a slave device could vary from module to module, even the same module types. In this case, most EC masters have to be forced to read the configuration specific PDO mapping via CoE. This is done by providing a default ESI file that only includes some general information (no PDO information), but it includes the instruction to read the PDO mapping Online via CoE.

Advantages of dynamic PDO configuration:

- Benefit from the maximum flexibility of Gantner Instruments' EtherCAT slave devices
- Slave configuration is always consistent with the EC master configuration

Disadvantages of dynamic PDO configuration:

- When using multiple slave devices, the init process will take more time to complete
- Not all EtherCAT masters currently support CoE functionality

Startup Time

When an EtherCAT master goes into operational state, the PDO configuration is created for all connected slave devices. When using dynamic PDO configuration, all connected slave devices are read via CoE. The init process can be more time consuming when there are a lot of slave devices connected at once.

The solution is to check whether the EC master and slave configurations are identical or not. If identical, then the PDO configuration via CoE can be skipped. A new PDO configuration will only be uploaded for slave devices that have a different PDO configuration than currently set in the master. This saves time during system init.

EC masters without CoE support

Most EtherCAT masters can read the PDO mapping Online via CoE, however some EC masters still only support slave configuration using an ESI file. Since there is an unlimited number of possible configuration combinations (especially when using complex EtherCAT slave modules like the Q.station XB), it is not easy (or simply not possible) to create a fixed ESI file for such setups.

Solutions:

- The simple master (application) gets the whole PDO configuration from a different master/tool that is able to read the configuration via CoE (this is usually done when using a real-time system containing only a basic master and a full featured configuration system with CoE support).
- The master is configured manually by an overlaying system that knows how the PDO mapping has to be built up.
- The master gets a static PDO configuration from the ESI files, which represents the exact module configuration.

6.1.2

Static PDO Configuration

Since the PDO configuration of simple EtherCAT slave devices is not configurable, loading the PDO mapping from an ESI file is a common way to configure the EtherCAT master. Most masters select the correct ESI file by vendor/type information from the attached slave device using a standard procedure.

It is possible to create a fixed configuration for a single Gantner EtherCAT slave device.

- ➔ In this case, it is not possible to benefit from the flexibility offered by Gantner Instruments' Q.series XE slave devices (modules).

Limitations:

- For each new module type that is connected to the EtherCAT bus, a new ESI file is required.
- Because the product code for each module is always the same, only 1 file per type may be included into an ESI library.
- A new ESI file is necessary if the PDO mapping of the module changes include the number of variables, data type of the variables, or data direction of the variables.
- The variable names in the ESI file are “anonymous”.

! IMPORTANT

The standard procedure for selecting slave PDO configurations based on vendor/type information is impossible if using differing ESI files for PDO configurations for the same slave device type.

Most EtherCAT masters can not deal with static PDO configuration and different PDO configurations for the same slave device.

If a master is able to differentiate between different ESI files for the same slave device type, then:

- A specific configuration can be identified by a MD5 checksum
- The mapping between a configuration specific ESI file and the corresponding configuration is up to master implementation (e.g., append the MD5 checksum to the file name or maintain a custom database)
- Creating ESI files based on a module configurations is simple

6.1.3

Configuration Check During Init

The EtherCAT standard does not describe a general rule to identify different device configurations. All Q.series XE modules have a MD5 checksum identifier via the SDO protocol.

The SDO 0x2000 (first SDO in the vendor specific range) shows the MD5 hash value. The MD5 checksum is available for the files:

- 0x01: MD5 configuration file
- 0x02: MD5 interface file
- 0x03: MD5 calibration file

The MD5 checksum calculation is done by the slave modules during init/startup or after a configuration change. The MD5 checksum is calculated based on the configuration file that is downloaded via RS485 or EtherCAT/FoE.

- Only a single SDO has to be read
- Identification or verification of a specific configuration is independent from how the EC master configuration is done

- Slave configuration could be read via CoE, but stored along with the MD5 checksum in a user defined manner
- A set of specific configurations can be stored on the EtherCAT master and selected Online after identifying the MD5 checksum of the attached module(s)

More vendor specific module information is available via SDOs (see Section 6.13, *Q.series XE Module SDO Information*, page 141).

6.2

Configuration via *GI.bench*

GI.bench is the recommended software for the configuration of all Q.series X products and it can be used to configure almost any other product developed by Gantner Instruments, excluding the e.series product line.

You may define Q.series XE configurations from within *GI.bench*. Projects in *GI.bench* are user-defined Gantner system templates, which contain the majority, if not all of the necessary settings for configuring a Gantner system or network of systems for specific operations per the unique needs of the user. The user can also define inputs from and outputs to external systems or other non-Gantner devices if a compatible method of communication is supported by the Q.series X system.

IMPORTANT

In *GI.bench*, each item within a project configuration tree can be clicked (i.e., to select), double-clicked (i.e., to open settings also accessible via context menu), and right-clicked (i.e., to access the context menu for all available options). Some settings are only accessible via the context menu. Use the context menu to either **Append**, **Insert**, or **Delete variable(s)** as needed.

Open the *Module settings* window by double-clicking on the desired Q.series XE module within the *GI.bench* project configuration tree or by right-clicking on the desired module and selecting **Edit module** in the context menu.

Open the *Variable settings* window by double-clicking on the desired variable within the *GI.bench* project configuration tree or by right-clicking on the desired variable and selecting **Edit variable** in the context menu.

6.3

Installing *GI.bench*

- ➔ We recommend closing all open programs before installation. Administrator rights will be required for the installation.

The latest version of *GI.bench* is available on our website www.gantner-instruments.com via **Resources > Downloads and Support Tools**. Scroll down to the *Downloads* section and in the *All types* drop-down menu, select **Software**, then in the search field to the right, type in “GI”. Click the **Download** link next to the relevant version of *GI.bench*, i.e., *32-bit* or *64-bit*.

Procedure

- Determine if your Operating System (OS) is *32-bit* or *64-bit*. Right click **Computer (or My PC) > Properties** (Fig. 6-1).
- Download the appropriate version based on your OS and unzip the contents.
- Follow the instructions in the setup program to select the installation directory for the software (Fig. 6-2).

The first time you start *GI.bench*, you may need to specify the language for the program interface. To change language at any time, select **Settings > Language**.

GI.bench requires a license in order to utilize the full software package. If you require a license for *GI.bench*, contact your local Gantner Instruments Sales & Service location for assistance.

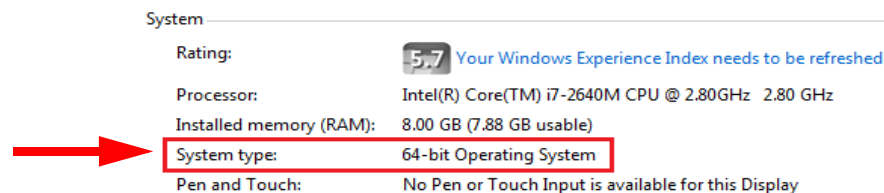

Fig. 6-1 Determine the type of operating system of connected PC

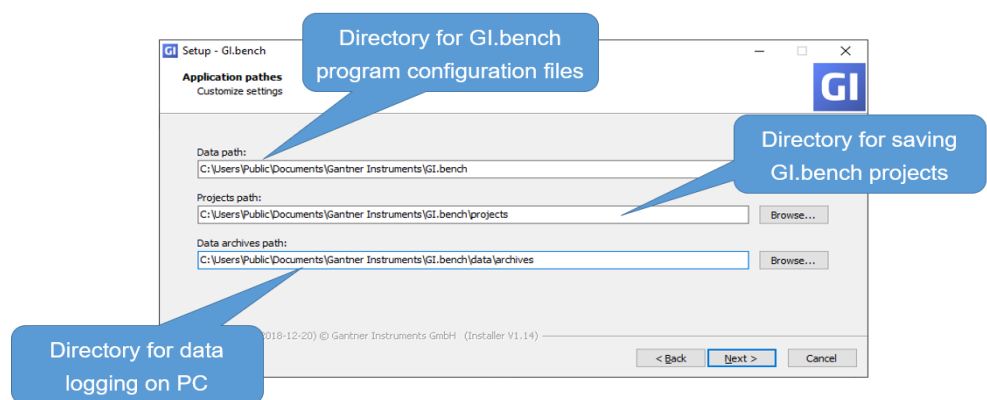

Fig. 6-2 Specifying *GI.bench* directories during initial program installation; can edit via the *GI.service* context menu

6.4

Communication & Configuring Parameters

You must first establish a connection between the Q.series XE BC and the PC before you can configure connected modules. Use *GI.bench* to establish a connection with the EtherCAT master.

A *GI.bench* license code is needed to use the full program. During the installation of *GI.bench*, the user can request a license of *GI.bench* via email. If the request is valid, then a license code is sent back to the user via email that activates *GI.bench*.

Once you have connected the bus coupler to the PC via EtherCAT RJ45 cable and have the *GI.bench* program running, perform the following steps:

1. Right-click on the GI icon in the Windows taskbar to bring up the context menu. Activate ***GI.TwincatFoE*** or ***GI.KpaFoE*** in the context menu depending on the EtherCAT master used.

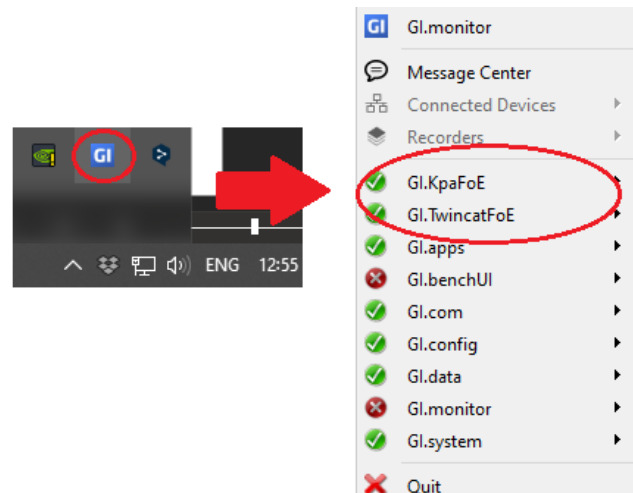

Fig. 6-3 Specifying the EtherCAT master interface with *GI.bench*

2. The modules can be imported in *GI.bench* by clicking on the ***Import*** button in the toolbar (Fig. 6-4).



Fig. 6-4 Importing module configuration files into *GI.bench*

3. In the pop-up prompt, select the desired method of import. Directly import module configurations from either *TwinCAT* or *KPAmaster*, or import using pre-existing Gantner external module configuration files (i.e., file extension: ***@e_*_c.gcf***).

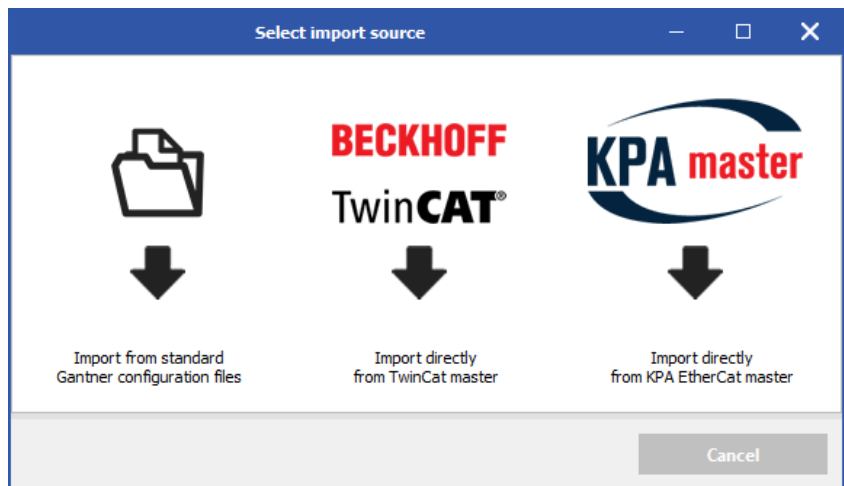

Fig. 6-5 Specify the desired module configuration import source

If you have a Gantner external module configuration file (i.e., file extension: **@e_*_c.gcf**) with the required settings available to you, select **Import** in GI.bench and select the folder icon that appears in Fig. 6-5 above, and navigate to the file as shown in Fig. 6-6 below.

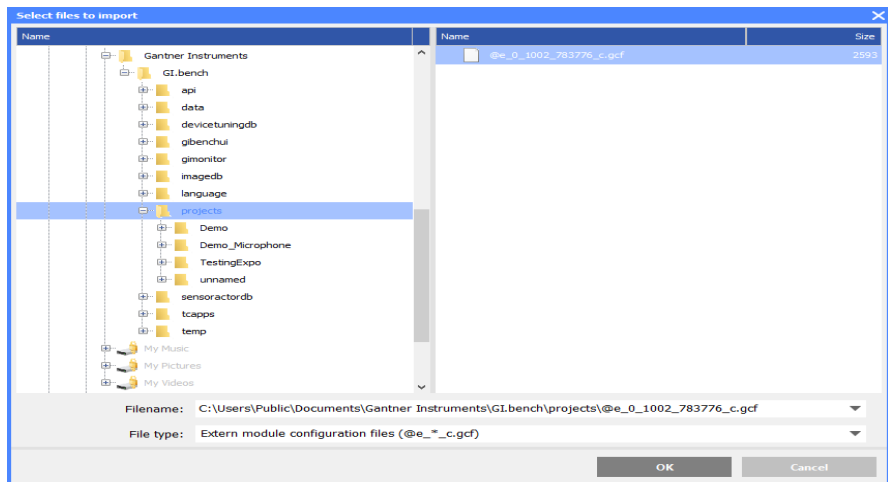

Fig. 6-6 Navigate to (and open) a previously saved .gcf file

If you use *TwinCAT* by Beckhoff Automation GmbH or *KPAmaster* by Koenig-pa GmbH, and wish to directly import configurations from the connected modules, select the appropriate EtherCAT master from within the pop-up prompt seen in Fig. 6-5 above.

4. Leave the upcoming window blank if the EtherCAT master is the PC you are working on. Otherwise, enter the NetID of EtherCAT master. Click **OK** to continue.

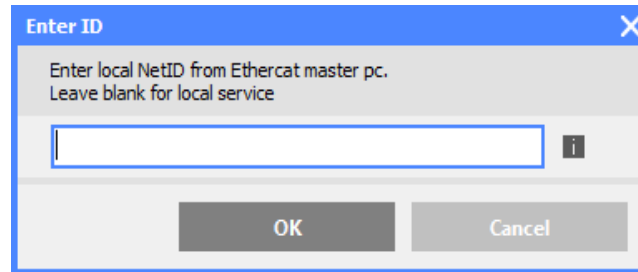

Fig. 6-7 Leave the Enter NetID window blank for a local network

! **IMPORTANT**

When combining used modules from previous applications with recently purchased modules, ensure that all devices are updated with the latest firmware.

The following describes the most important steps in configuring a system suitable for acquiring measurements.

Basic Procedure

- Establish a connection between the EtherCAT master on the PC and the module(s) via a Q.series XE BC using *GI.bench*;
- Import all configurations from the Q.series XE system.
- Define the modules, sensors, and the scaling used to obtain quality measurements of a physical quantities.
- Define arithmetic computations, digital inputs/outputs, alarm monitoring, etc.
- Export all configurations to the Q.series XE system.

i **Tip**

In *GI.bench*, you can call setting dialogs via the context menu of an entry. You call the context menu with the right mouse key.

6.5

Configuring Analog Inputs in *GI.bench*

6.5.1

Sensor Parameters in *GI.bench*

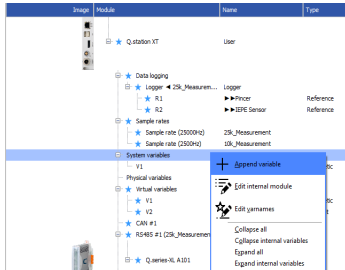

In order to adjust channel configurations for analog variables, the modules should be physically connected to the Q.series XE BC and the configuration program, *GI.bench*, should be installed and licensed, i.e., ready for measurement. For more information on the installation of *GI.bench*, refer to Section 6.3, *Installing GI.bench*, page 111 for detailed instructions.

Right-click on a module and select **Append Variable** from the context menu to add a new variable to the module. Note that double-clicking on a module will bring up the *Module settings* window instead. From the *Module settings* window, the module **Location**, **Address**, and **Data-transfer** status are configured.

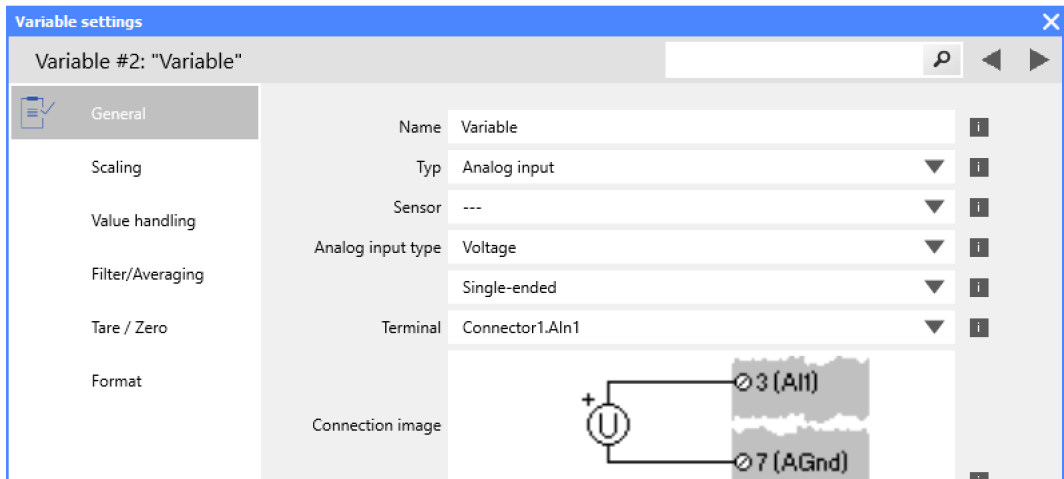

Fig. 6-8 Variable settings for single-ended voltage input via A101

All module signals are defined as *variables*. Double-click on any variable or right-click on any variable and select **Edit variable** to open the *Variable settings* window for configuration.

Procedure

1. Double-click on any variable or right-click on any variable and select **Edit variable** to open the *Variable settings* window for configuration.
2. Define the **Name** of the variable, e.g., Voltage Input 1.
3. Define the **Sample rate** of the Analog input variable.
4. Select the variable **Type** as **Analog input**.
5. Define the **Sensor** type to be used.

Depending on the type of module, you have various options available, e.g. **Bridge** for strain gage full and half-bridges, **Pt100/500/1000** or **Resistance** for resistors, and **Voltage** for voltage measurements. Selecting a **Sensor** may update **Analog input type**, **Scaling**, or **Value handling** accordingly.

6. Define the **Analog input type** and specify a type of circuit or additional variation of the selected sensor type if available.

Depending on the selected sensor type, you have various options available, e.g. **2-wire** or **4-wire** (circuit) for resistive transducers and **Resistive Full 3-, 4-, 5-, 6-wire** (circuit) for strain gage full bridges.

The **Connection image** shows you the pin assignment to be used. With more than one input, inputs are to be connected from first to last (i.e., Input 1 on Plug 1, to Input n on Plug 2, etc.). Check that all sensors are connected correctly.

7. Click on **Scaling** to define the scaling settings for the sensor.

Depending on the type of sensor selected, you have various options available (refer also to Section 7.2, *Sensor Scaling in GI.bench*, page 144):

- For voltage signals, specify a conversion of the measured voltage to a desired physical quantity. By default, sensor inputs are measured without conversion (scaling).
- For thermocouples or Pt100 sensors, no additional scaling is required as the conversion into °C occurs automatically. The scaling is only needed when you want to convert to °F or K. In this case, define the **Unit** and **Scaling method**. Default method is **Factor and offset**. For a display in °F enter the factor **1.8** and **32** as the offset. For a display in °K enter the factor **1** and **-273.15** as the offset.
- For full and half-bridge transducers, obtain the necessary information from a data sheet or a transducer calibration certificate. E.g., for a force transducer (2.03mV/V at 5kN), enter the **Unit (kN)** and then click on **Scaling method**. Use the method **2-point calibration**. Enter in each case **0** for **Point 1** for **Interm.(ediate) [mV/V]** and **Eng.(ineering) [kN]**. Then enter **2.03** as **Interm.(ediate) [mV/V]** and **5** as **Eng.(ineering) [kN]** for **Point 2**.
Alternatively, you can also define **N** for **Unit** and then **5000** as **Eng.(ineering) [kN]** for **Point 2**.
- For strain gages, an additional tool called **Strain gage calculator** is available. Here, the unit is automatically changed to **µm/m**. In the *Variable settings* window, enter the **k factor** of your strain gage and the **Bridge factor (B)** for the circuit.

8. Floating point numbers are always transferred as 4-byte values, therefore, no further changes to **Format** will be needed.

For the formats **Signed integer 16-bit** (2 bytes) and **Signed integer 32-bit** (4 bytes), ensure to specify the **Precision** and the total number of places to be output (**Fieldlength**). The **Fieldlength** is calculated including the initial decimal point and is displayed without commas in thousandths positions, e.g., specifying three decimal places displays the value 1234 (i.e., as opposed to 1,234).

After defining the settings above, the number of transferred decimal places are displayed in the *Format* column within the project **Configuration** tree, e.g. #####.##.

If negative numbers occur, the displayed value in this example is limited to -9999.99 (seven characters without the comma).

9. In the **Value handling** options, you may adjust the **Range** and **Error handling** to manually limit the admissible value range and to define the reaction in the case of an error (optional).
10. Specify filtering of the sensor signal in the options **Filter/Averaging**.
11. Save configurations by clicking **OK** once you have made all the necessary changes to *Variable settings*.
If changes to the project are complete, click **Export** to upload the configuration files to the scanned Q.series XE modules.
A file is created within the project folder and bears the same name as the project.

IMPORTANT

In *GI.bench*, a  is displayed next to any items within the project configuration tree that have received changes. To commit updated settings, select **Export** button from the toolbar.

6.5.2

Carrier Frequency Synchronization (Q.series XE A106)

The A106 module supports the supply of sensors with direct voltage (**DC**) or carrier frequency (**CF 600 Hz** and **CF 4800 Hz**).

- ➔ If you are using several modules of this type and define a carrier frequency supply (**CF 600 Hz** or **CF 4800 Hz**), synchronize the carrier frequencies of the modules otherwise crosstalk can occur between the supply line and signal inputs of the modules.

After selecting a carrier frequency, you have three methods of supply:

1. **No sync.**(hronization)

This setting is only practical when you are using one module with carrier frequency supply. Within a single module all carrier frequency generators are automatically synchronized.

2. **Internal sync.**(hronization)

Set this type of synchronization for *one* module. The module becomes the master to which all other modules synchronize.

3. **External sync.**(hronization)

Specify this type of synchronization for *all* other modules that are to be synchronized to the master module.

For synchronization, the CF-SYNC interfaces on the front of the Q.series XE BC are utilized.

i Tip

We recommend that only one variant of the carrier frequency is used, i.e. do not mix 600 Hz and 4800 Hz with multiple modules.

6.5.3

Zeroing and Taring Sensor Measurements

You have two ways of adjusting a measurement offset to zero, e.g., for applications involving pre-loaded sensors:

- **Zero**

With this method, measurement takes place over a certain time period and the mean is computed. This mean value is then subtracted from all the following measurements.

- **Tare**

With this method, a (single) measurement present at a certain point in time is subtracted from all following measurements.

Zeroing and taring are performed manually as needed during test setup and are triggered manually or automatically via variables. Gl.bench cannot activate zeroing and taring during EtherCAT measurement because it cannot communicate with the modules.

Manual Activation (via host)

In the *Variable settings* window of the influenced variable (the variable to be zeroed or tared), access the **Format** tab and define the **Data direction** as **Input/Output** (Fig. 6-9, page 119).

In the **Tare/Zero** tab of the *Variable settings* window, check the box for **Zero on host** or **Tare on host** (Fig. 6-9, page 119).

The master must write the appropriate code(s) to the output-PDO of the influenced variable. The output value is checked to activate either Zero, Tare or both. Refer to Fig. 6-10, page 120 for the list of acceptable codes.

Automatic/Manual Activation (via variable)

In the **Tare/Zero** tab of *Variable settings* window, check the box for **Zero on variable** or **Tare on variable** (Fig. 6-11, page 120).

An additional field will appear under the **Zero on variable** or **Tare on variable** options to select a reference variable that is checked to activate the desired operation (Fig. 6-11, page 120).

The master must change the value of this referenced variable to the appropriate code(s) for the desired operation(s) to activate. The codes can be referenced from Fig. 6-10, page 120.

Procedure (via variable)

1. Create a new reference variable and specify a **Name** for the variable, e.g., the purpose of the signal such as Zero_tare.
2. Within the *Variable settings* of the influenced variable, go to the **Tare/Zero** tab and select the desired condition(s), i.e., **Tare on variable** or **Zero on variable** (Fig. 6-11, page 120).
3. Select the referenced variable (e.g., Zero_tare) to be checked to activate the desired operation (Fig. 6-11, page 120).
4. Close the *Variable settings* window by clicking **OK**.
5. Change the value of this referenced variable to the appropriate code(s) to trigger the desired operation(s).

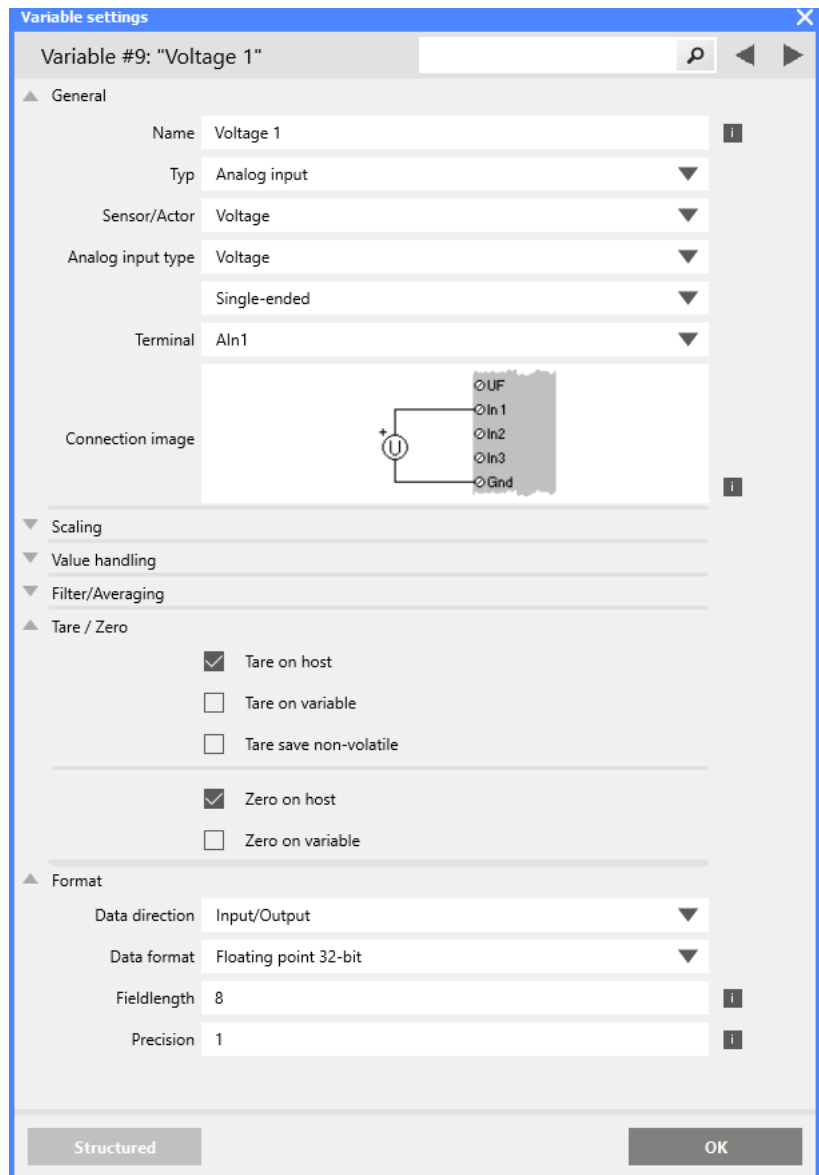

Fig. 6-9 Define on host activation for Zero and/or Tare

Code	Function
1	Perform taring
2	Reset tare (delete stored tare value)
4	Perform zeroing. The mean of the measurement value is calculated until the value 0 is written to the variable.
8	Reset zero balance (delete stored zero value)
16	Activate Shunt Resistor or Reset charge input

Fig. 6-10 Codes for activating Zero/Tare/Shunt Resistor



Variable settings

Variable #9: "Voltage 1"

General

Name: Voltage 1

Typ: Analog input

Sensor/Actor: Voltage

Analog input type: Voltage

Single-ended

Terminal: Aln1

Connection image

Scaling

Value handling

Filter/Averaging

Tare / Zero

Tare on host

Tare on variable

Variable: Zero_tare

Tare save non-volatile

Zero on host

Zero on variable

Variable: Zero_tare

Format

Data direction: Input

Data format: Floating point 32-bit

Fieldlength: 8

Precision: 1

Structured OK

Fig. 6-11 Define on variable activation for Zero and/or Tare

6.6

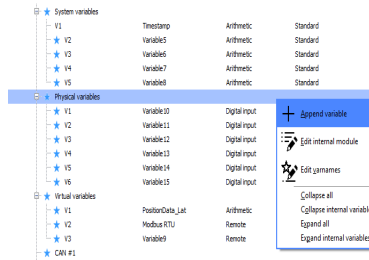
Defining Digital Inputs & Outputs in *GI.bench*

In order to adjust channel configurations for digital variables, the modules should be physically connected to the Q.series XE BC and the configuration program, *GI.bench*, should be installed and licensed, i.e., ready for measurement. For more information on the installation of *GI.bench*, refer to Section 6.3, *Installing GI.bench*, page 111 for detailed instructions.

Right-click on a module and select **Append Variable** from the context menu to add a new variable to the module. Note double-clicking on a module will bring up the *Module settings* window instead. In the *Module settings* window, the module **Location**, **Address**, and **Data-transfer** status are configured.

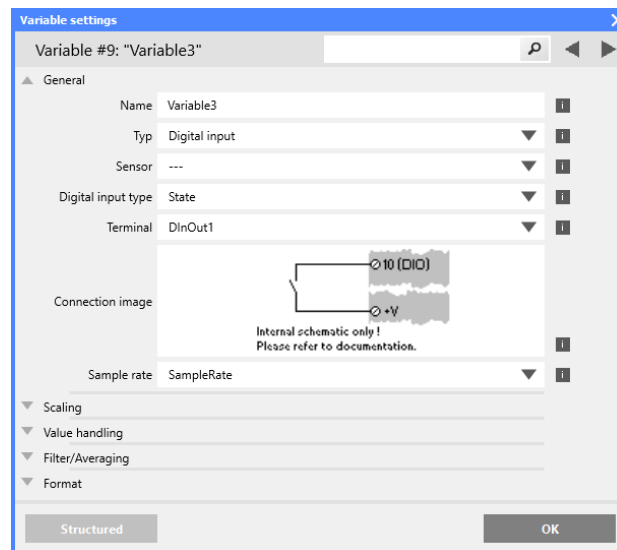



Fig. 6-12 Configuring a digital input via *Variable settings*

Procedure

1. Double-click on any variable or right-click on any variable and select **Edit variable** to open the *Variable settings* window for configuration.
2. Define the **Name** of the variable, e.g., Digital Output 1.
3. Define **Sample rate** for the digital input.
4. Select the variable **Type** as **Digital input** or **Digital output**. The **Connection image** shows you the pin assignment to be used. With more than one input, inputs are to be connected from first to last (i.e., Input 1 on Plug 1, to Input n on Plug 2, etc.). Check that all sensors are connected correctly.
5. For **Digital output**, click on **Digital output type** and specify whether you want to use the output as **State**, **Output set**, **Process output**, or **PWM/Frequency**.
Process output: The output monitors a module signal and changes the output level under certain conditions. Click on **Threshold (OR combined)** and specify alarm conditions.

- You can specify up to four alarm conditions. When one of the conditions is satisfied, the alarm signal is triggered.
 - Select the desired alarm monitoring switching behavior and the levels at which switching is to occur.
 - Enter the variable based switching level (for **Value type: *Is variable***) or the constant based switching level (for **Value type: *Is constant***).
6. Click on **Format** to configure the data transfer.
Since digital signals do not require any decimal places, you can enter **0** for **Precision**. An entry of **1** is sufficient for the **Fieldlength**. With a digital input you can also specify a Unit within the **Scaling** options (optional).
7. Save configurations by clicking **OK** once you have made all the necessary changes to *Variable settings*.
Once all changes to the project are complete, click **Export** to upload the configuration files to the Q.series XE system.

! **IMPORTANT**

In *GI.bench*, a  is displayed next to any items within the project configuration tree that have received changes. To commit the updated settings, select **Export** button from the toolbar.

6.7

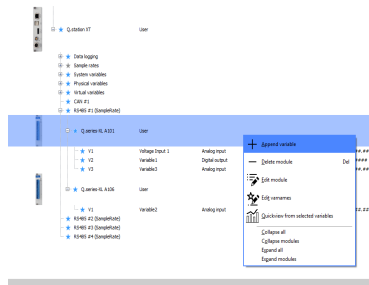
Configuring Analog Outputs in *GI.bench*

In order to adjust channel configurations for analog variables, the modules should be physically connected to the Q-series XE BC and the configuration program, *GI.bench*, should be installed and licensed, i.e., ready for measurement. For more information on the installation of *GI.bench*, refer to Section 6.3, *Installing GI.bench*, page 111 for detailed instructions.

Once the Q-series XE modules are scanned into *GI.bench* via **Import** (refer to Section 6.4, *Communication & Configuring Parameters*, page 112), right-click on a module and select **Append Variable** from the context menu to add a new variable to the module. Note that double-clicking on a module will bring up the *Module settings* window instead. From the *Module settings* window, the module **Location**, **Address**, and **Data-transfer** status are configured.

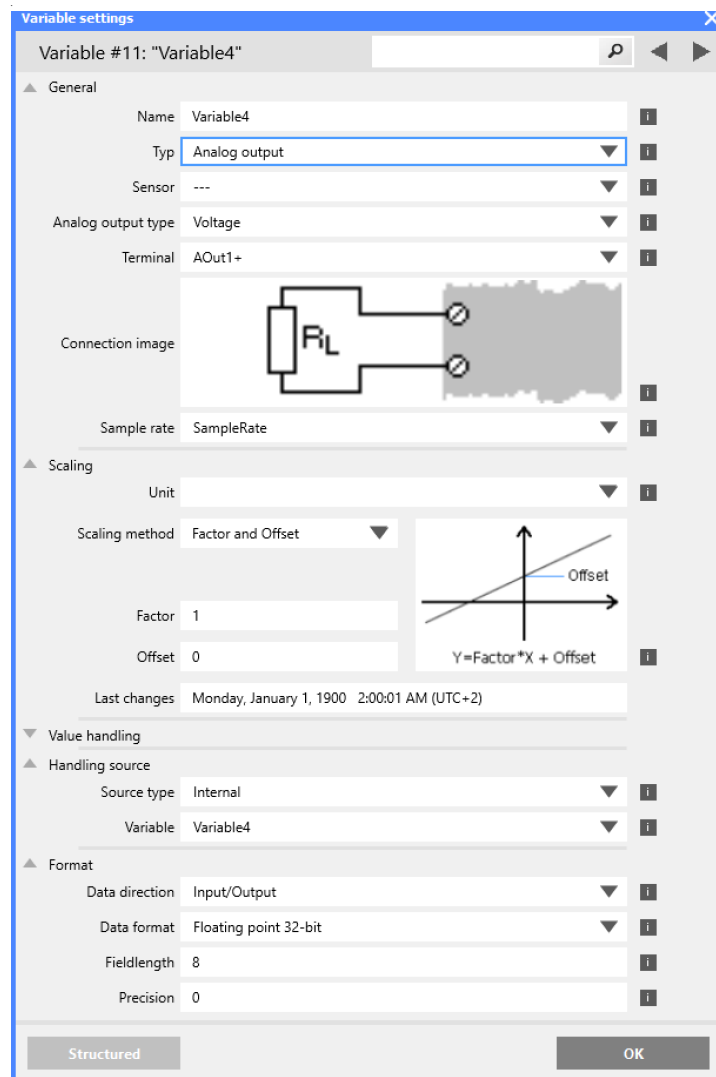

Fig. 6-13 Variable settings for the configuration of analog outputs

Procedure

1. Double-click on any variable or right-click on any variable and select **Edit variable** to open the *Variable settings* window for configuration.
2. Define the **Name** of the variable, e.g. Analog Output 1.
3. Select the variable **Type** as **Analog output**.
The **Connection image** shows you the pin assignment to be used. With more than one input, inputs are to be connected from first to last (i.e., Input 1 on Plug 1, to Input *n* on Plug 2, etc.). Check that all sensors are connected correctly.
4. Click on **Analog output type** and specify whether you want to use the output as **Voltage** or **Current**.
5. Select the desired **Terminal** for the analog output variable.
6. In the **Format** options, the output format is shown however changes are not necessary.
7. Click on **Value handling** to define the range **Minimum** and **Maximum**), **Overflow** and **Underflow values**, and **Error handling**.
8. Click on **Handling Source** to specify the signal source (**Source type** and **Variable**) used for the output.
9. Save configurations by clicking **OK** once you have made all the necessary changes to *Variable settings*.
Once all changes to the project are complete, click **Export** to upload the configuration files to the Q.series XE system.
A file is created within the project folder and bears the same name as the project.

! **IMPORTANT**

In *GI.bench*, a ★ is displayed next to any items within the project configuration tree that have received changes. To commit the updated settings, select **Export** button from the toolbar.

6.8

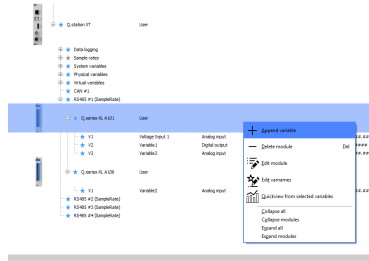
Defining Arithmetic Channels in *GI.bench*

In order to adjust channel configurations for virtual variables, the modules should be physically connected to the Q-series XE BC and the configuration program, *GI.bench*, should be installed and licensed, i.e., ready for measurement. For more information on the installation of *GI.bench*, refer to Section 6.3, *Installing GI.bench*, page 111 for detailed instructions.

Once the Q-series XE modules are scanned into *GI.bench* via **Import** (refer to Section 6.4, *Communication & Configuring Parameters*, page 112), right-click on a module and select **Append Variable** from the context menu to add a new variable to the module.

Note that double-clicking on a module will bring up the *Module settings* window instead. From the *Module settings* window, the module **Location**, **Address**, and **Data-transfer** status are configured.

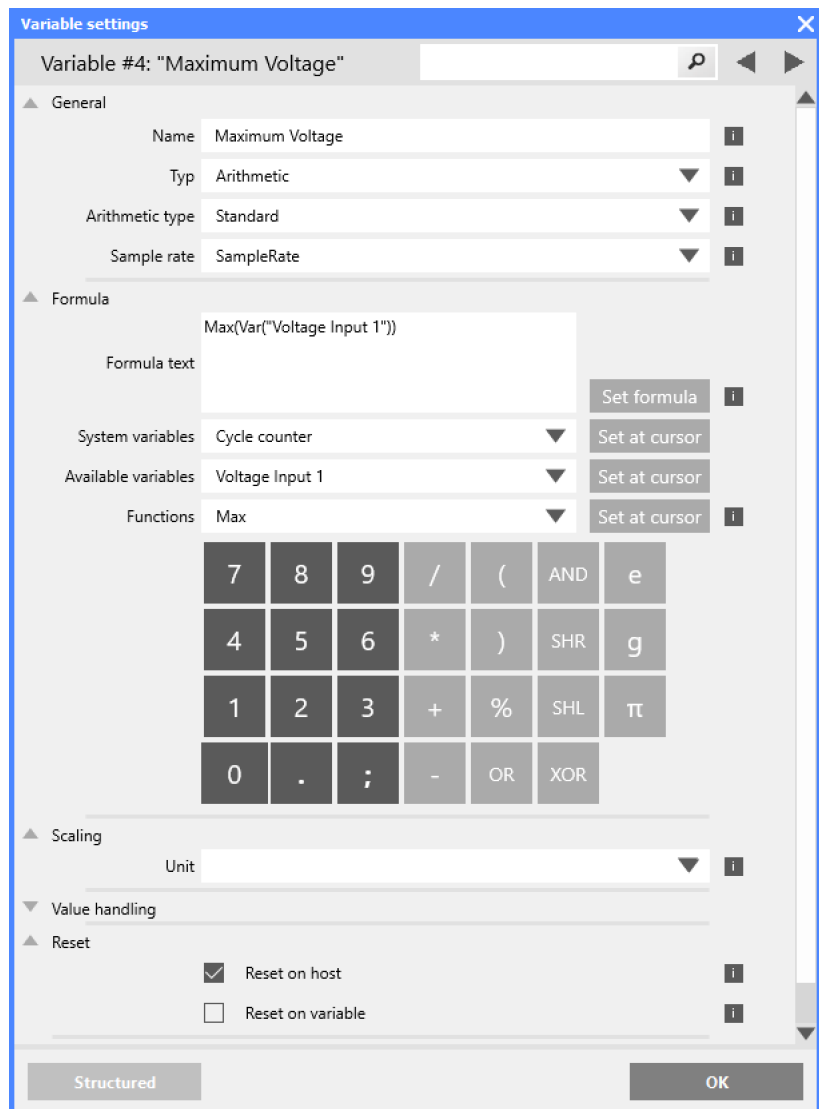

Fig. 6-14 Dialog with configuration for a computation

Procedure

1. Double-click on any variable or right-click on any variable and select **Edit variable** to open the *Variable settings* window for configuration.
2. Define the **Name** of the variable, e.g. Maximum Voltage.
3. Select the variable **Type** as **Arithmetic**.
4. In the **Formula** tab, click on the **Functions** drop-down menu and specify the required computation.

In the upper dialog field you can enter, as on a pocket calculator, a formula which can use existing module variables. Create functions via the **Set at cursor** buttons and commit changes to a formula via **Set formula**. Click on **OK** once you have defined the required computation.

5. Floating point numbers are always transferred as 4-byte values, therefore, no changes to **Format** settings are necessary. For the formats **Signed integer 16-bit** (2 bytes) and **Signed integer 32-bit** (4 bytes), ensure to specify the **Precision** and the total number of places to be output (**Fieldlength**). The **Fieldlength** is calculated including the initial decimal point and is displayed without commas in thousandths positions, e.g., specifying three decimal places displays the value 1234 (i.e., as opposed to 1,234).

After defining the settings above, the number of transferred decimal places are displayed in the *Format* column within the project **Configuration** tree, e.g. #####.##.

If negative numbers occur, the displayed value in this example is limited to -9999.99 (seven characters without the comma).

6. Save configurations by clicking **OK** once you have made all the necessary changes to *Variable settings*.
Once all changes to the project are complete, click **Export** to upload the configuration file to the Q.series XE BC.
A file is created within the project folder and bears the same name as the project.

IMPORTANT

In *GI.bench*, a  is displayed next to any items within the project configuration tree that have received changes. To commit the updated settings, select **Export** button from the toolbar.

6.9

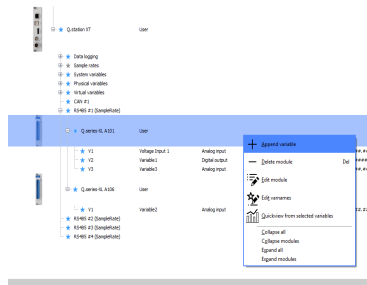

Configuring Alarm Monitoring in *GI.bench*

In order to adjust channel configurations for alarm monitoring, modules should be physically connected to the Q.series XE BC and the configuration program, *GI.bench*, should be installed and licensed, i.e., ready for measurement. For more information on the installation of *GI.bench*, refer to Section 6.3, *Installing GI.bench*, page 111 for detailed instructions.

Once the Q.series XE modules are scanned into *GI.bench* via **Import** (refer to Section 6.4, *Communication & Configuring Parameters*, page 112), right-click on a module and select **Append Variable** from the context menu to add a new variable to the module. Note that double-clicking on a module will bring up the *Module settings* window instead. From the *Module settings* window, the module **Location**, **Address**, and **Data-transfer** status are configured.

➔ In order to monitor a limit and to output a level on a digital output when an alarm occurs, you can directly use the function of the digital output. You do not need to set up alarm monitoring via a separate variable. Alarm monitoring is used to monitor signals for modules and to make the result available to the PC or PLC as a preconditioned signal.

Procedure

1. Double-click on any variable or right-click on any variable and select **Edit variable** to open the *Variable settings* window for configuration.
2. Define the **Name** of the variable, e.g. Input 1 High Level.
3. Select the variable **Type** as **Alarm**.
4. Select the desired **Sample rate** for the virtual variable. Click on **Threshold (OR combined)** and specify conditions.
 - You can specify up to four alarm conditions. When one of the conditions is satisfied, the alarm signal is triggered.
 - Select the desired alarm monitoring switching behavior and the levels at which switching is to occur.
 - Enter the variable based switching level (for **Value type: Is variable**) or the constant based switching level (for **Value type: Is constant**).
5. Click in the column **Format/balance** to specify the transfer format.

Since the alarm signal, like digital signals, does not require any **Decimal** places, you can enter **0** here. **1** is sufficient for the **Field length**.

When the dialog is closed, the number of transferred places and the unit in the column **Format/balance**, e.g. **f**, are displayed.

6. Save configurations by clicking **OK** once you have made all the necessary changes to *Variable settings*.
Once all changes to the project are complete, click **Export** to upload the configuration file to the Q.series XE system.
A file is created within the project folder and bears the same name as the project.

! IMPORTANT

In *GI.bench*, a ★ is displayed next to any items within the project configuration tree that have received changes. To commit the updated settings, select **Export** button from the toolbar.

6.10

Setting Oversampling (XFC)

As explained in Section 4.6, page 21, the Q.series XE modules support the XFC Technology (*eXtreme Fast Control Technology*) from Beckhoff Automation GmbH. It is used to transfer several measurements per telegram for certain channels. You can adjust the setting in the Variable settings window in the **Oversampling** tab. In this tab double-click on the relevant channel to call the setup dialog (Fig. 6-15).

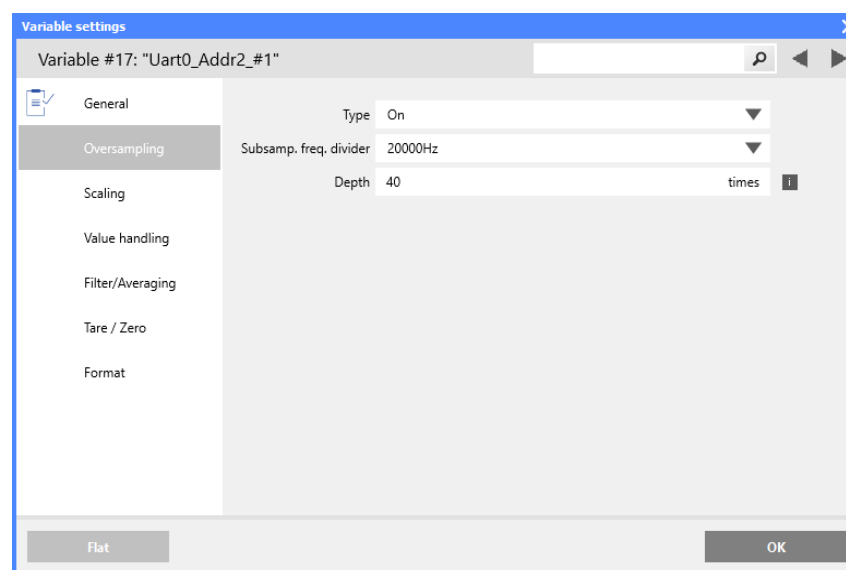

Fig. 6-15 Setting oversampling in the Variable settings window

In Fig. 6-15 the oversampling is set for the first channel (V1) of an A101 module. The module A/D converter operates at 100kHz. In this example, the measurements are to be transferred at 20,000 values per second, i.e. every 5th value (**subsample frequency**). In order to be able to transfer these values with a master cycle time of 2 ms (500 Hz sample rate), the **Depth** of values to be transferred per telegram is set to 40. Consequently, 40 values are transferred every 2 ms, i.e. in total 20,000 values per second. With a cycle time of 1 ms the **Depth** could be reduced to 20.

- ➔ The **Async. buffered** mode is intended for angular synchronous measurements. If required, please contact Gantner Support (www.gantner-instruments.com) for additional assistance.

6.11

Module Firmware Updates via ICP100

Recently purchased modules always contain the latest firmware, i.e. the software in the modules is the current version. However, if you want to combine these modules with older modules, you should update all older modules and your software to the latest version, to avoid disturbances in operation.

The current firmware is in each case included in the latest installations of the programs *ICP100*. If required, download the latest versions from our web site: www.gantner-instruments.com via **Resources > Downloads and Support Tools**. Scroll down to the *Downloads* section and in the *All types* drop-down menu, select **Software**, then in the search field to the right, type in "ICP". Click the **Download** link next to the relevant version of *ICP100*.

Procedure

1. In the program *ICP100* select **Utilities > Download > Firmware update**.
2. Select the required menu (Fig. 6-16) and click on **OK**.

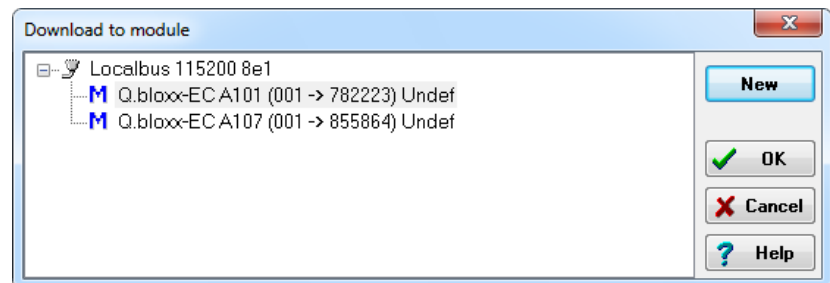

Fig. 6-16 Selecting the module for firmware update.

3. Select the file with the firmware (there is only one suitable for the module and where several are available the relevant latest version is displayed) and click on **Open** (Fig. 6-17).

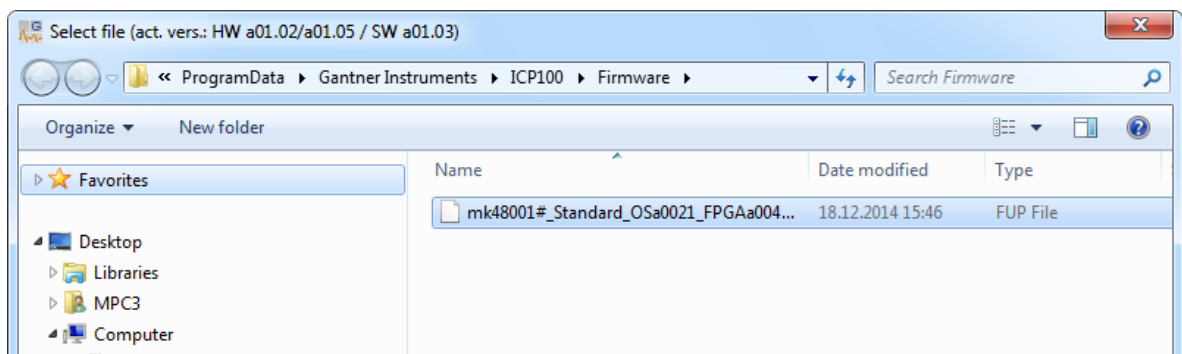

Fig. 6-17 Selecting the firmware.

6.12

Communication & Configuration with *TwinCAT*

The following descriptions apply to EtherCAT package *TwinCAT 3* from Beckhoff Automation GmbH. For use with other EtherCAT masters, different terms may be used, but the basic methods in this manual are the same.

To configure the measurement modules, the EtherCAT master must support CoE and FoE. If your EtherCAT master does not support CoE and FoE, contact your local Gantner Instruments Sales & Service location for further assistance.

Basic Procedure

- “GantnerInstruments.xml” has to be made available to the master. This file decodes the product-code sent by the slave during system scan. The module can be identified by this code and the abilities of the module is defined by the file’s content.
- Configure the EtherCAT master for the interface to be used.
- Find the devices connected to the interface – the Q.series XE BC (bus coupler) and any connected measurement modules.
- Configure the Q.series XE system.

You will find examples for the configuration of the modules in Section 6.12.4, page 136.

6.12.1

Module Configuration Files for EtherCAT Masters

1. In Windows Explorer, type “%ProgramData%” in the address line (Fig. 6-18).

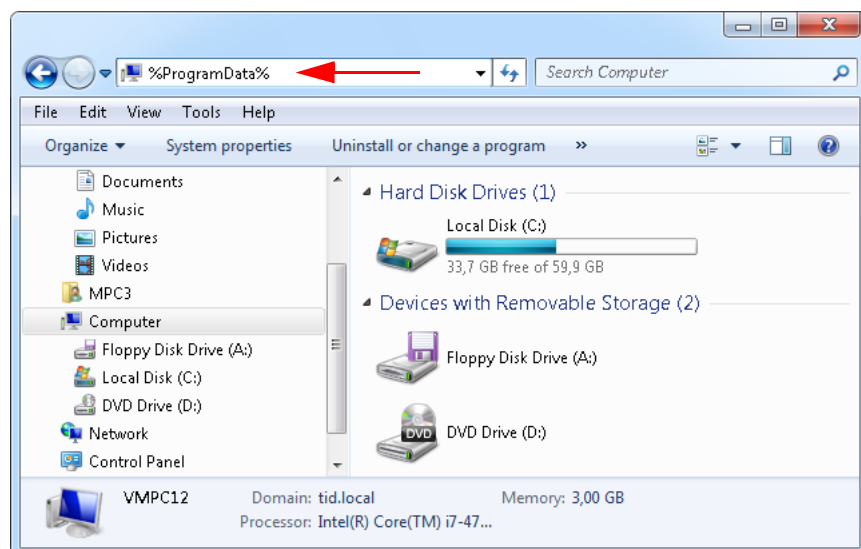

Fig. 6-18 Navigate to the (hidden) directory ProgramData

- Open the directory **Gantner Instruments > ICP100 > EtherCAT** and copy the file “Gantner Instruments.xml”

➔ The file contains the information about the possible settings for the Gantner modules for EtherCAT.

- Insert the XML file into the *TwinCAT* installation directory or into the appropriate subdirectory, e.g., **Io > EtherCAT**.

The configuration file is read in and processed during the next start of the program.

6.12.2

Defining an Interface

- For *TwinCAT 3*, select **TwinCAT > Show Realtime Ethernet Compatible Devices** (Fig. 6-19).

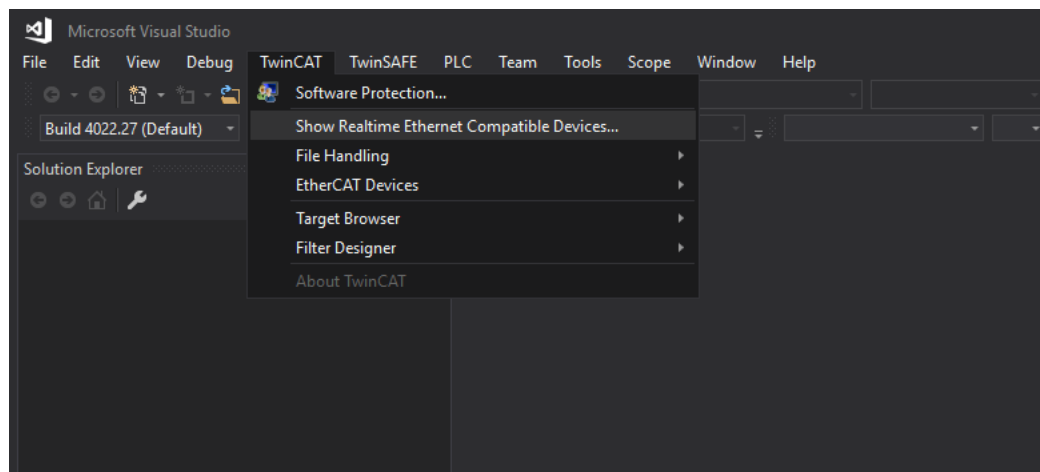

Fig. 6-19 Setting up the interface adapter with TwinCAT 3

- Select the appropriate interface adapter that appears under **Compatible devices** and click **Install** to install the real-time driver for the adapter (Fig. 6-20).

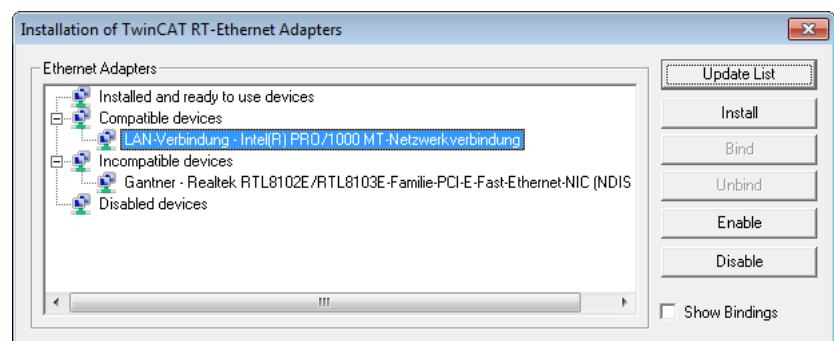

Fig. 6-20 Selecting the interface adapter

Once the driver is installed, the adapter appears under **Installed and ready to use devices (realtime capable)** (Fig. 6-21, page 132).

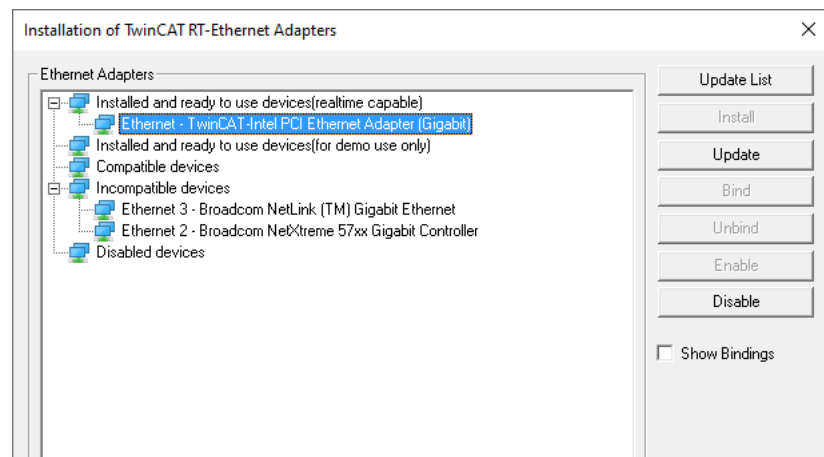

Fig. 6-21 Interface adapter with installed driver.

6.12.3

Linking Q.series XE Modules in TwinCAT

1. For *TwinCAT 3*, in the Solution Explorer, highlight **Devices** under **I/O**, and select **TwinCAT > Scan** (Fig. 6-22) in menu.

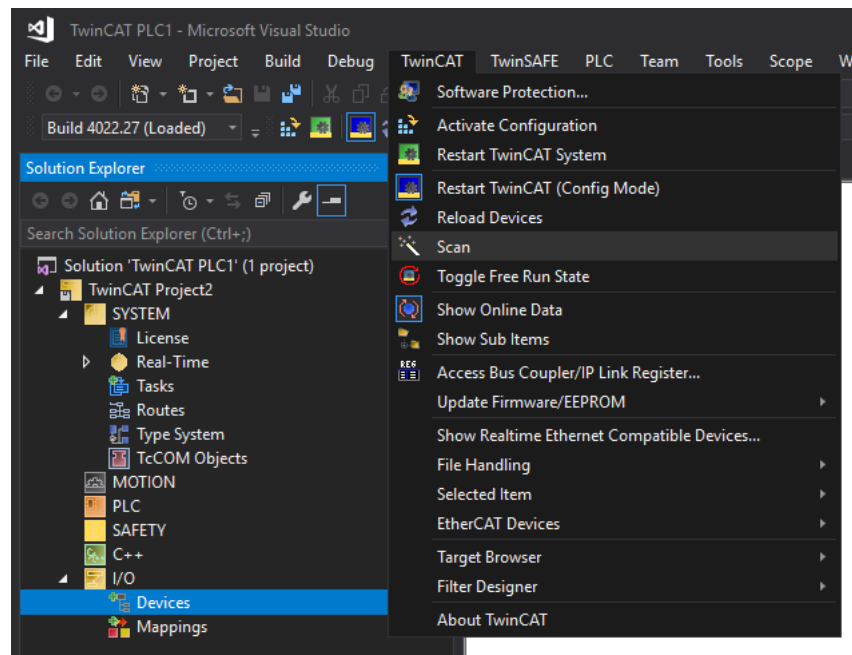

Fig. 6-22 Scanning for Gantner measurement devices (TwinCAT 3)

2. A dialog will appear hinting that not all device types can be automatically detected (Fig. 6-23). Click **OK** to continue.

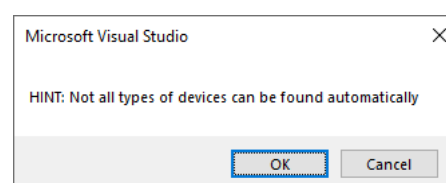

Fig. 6-23 Notice from TwinCAT when scanning for devices

- The device scan will attempt to find new Ethernet adapters with the EtherCAT driver (Fig. 6-24). Click **OK** to continue.

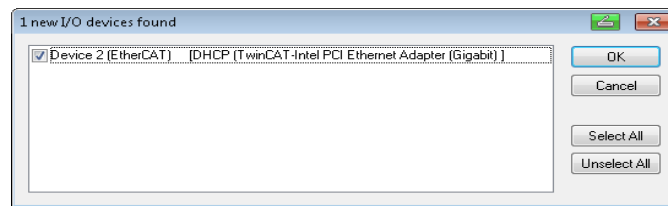

Fig. 6-24 Ethernet adapter with EtherCAT driver

- A dialog will ask whether you want to scan for devices (boxes) connected to the interface (Fig. 6-25). Click **Yes**.

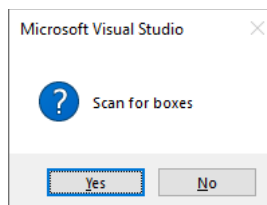

Fig. 6-25 Searching the connected devices (or boxes)

- In the next dialog window, click on **Yes** when asked whether “Free Run” operating mode should be activated (Fig. 6-26).

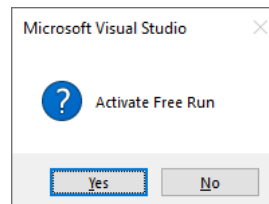

Fig. 6-26 Activating the “Free Run” operating mode

If there aren't any new I/O devices connected to the interface or if new I/O devices cannot be found for some reason, a dialog will appear notifying you accordingly (Fig. 6-27).

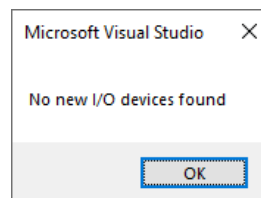

Fig. 6-27 Activating the “Free Run” operating mode in TwinCAT 3

TwinCAT reads parts of the ET1100 configuration files from the bus coupler and the different connected modules. Through this, the types of modules are detected. The read codes are transferred to readable information with the Gantner Instruments.xml file. Once read, the devices appear in the tree (Fig. 6-28, page 134).

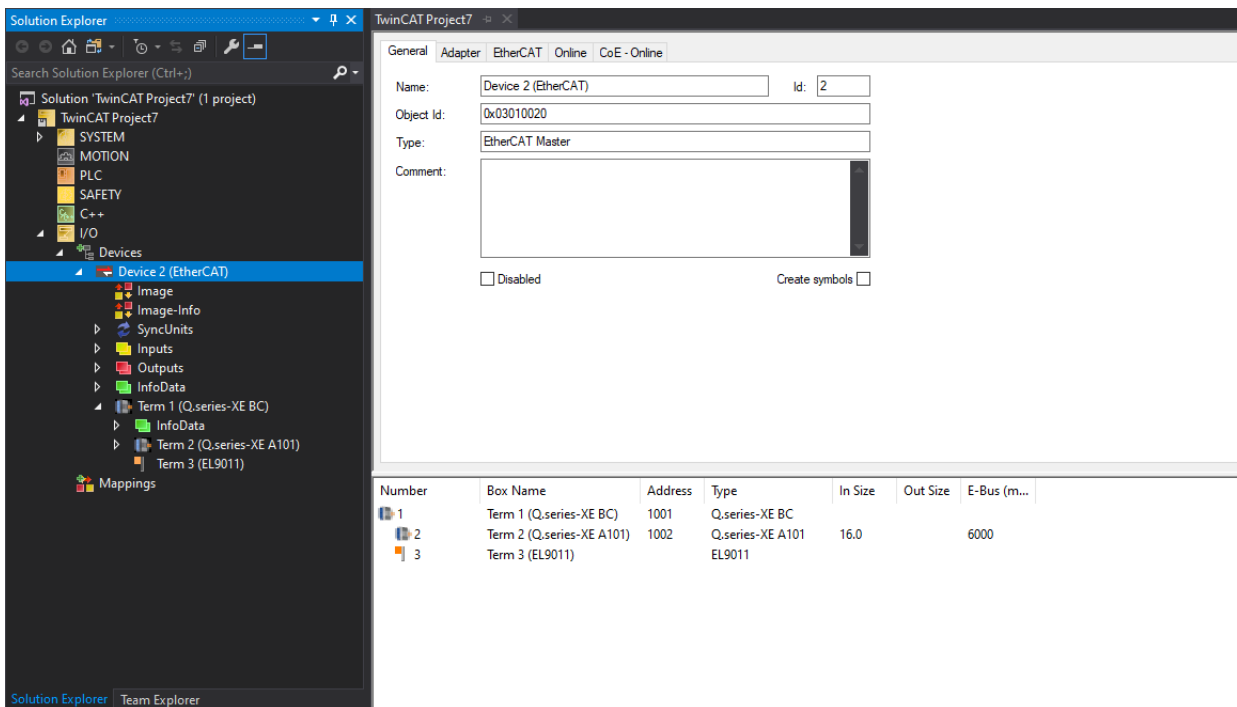

Fig. 6-28 Scanned EtherCAT device listed in the Solution Explorer

Expand “Term 1” (i.e., Q.bloxx XE BC) in the Solution Explorer tree to view connected modules (Term 2 and so on). In Fig. 6-29, the module Q.bloxx XE A101 is listed in the tree as Term 2. To view inputs and outputs, select or expand the module in the tree.

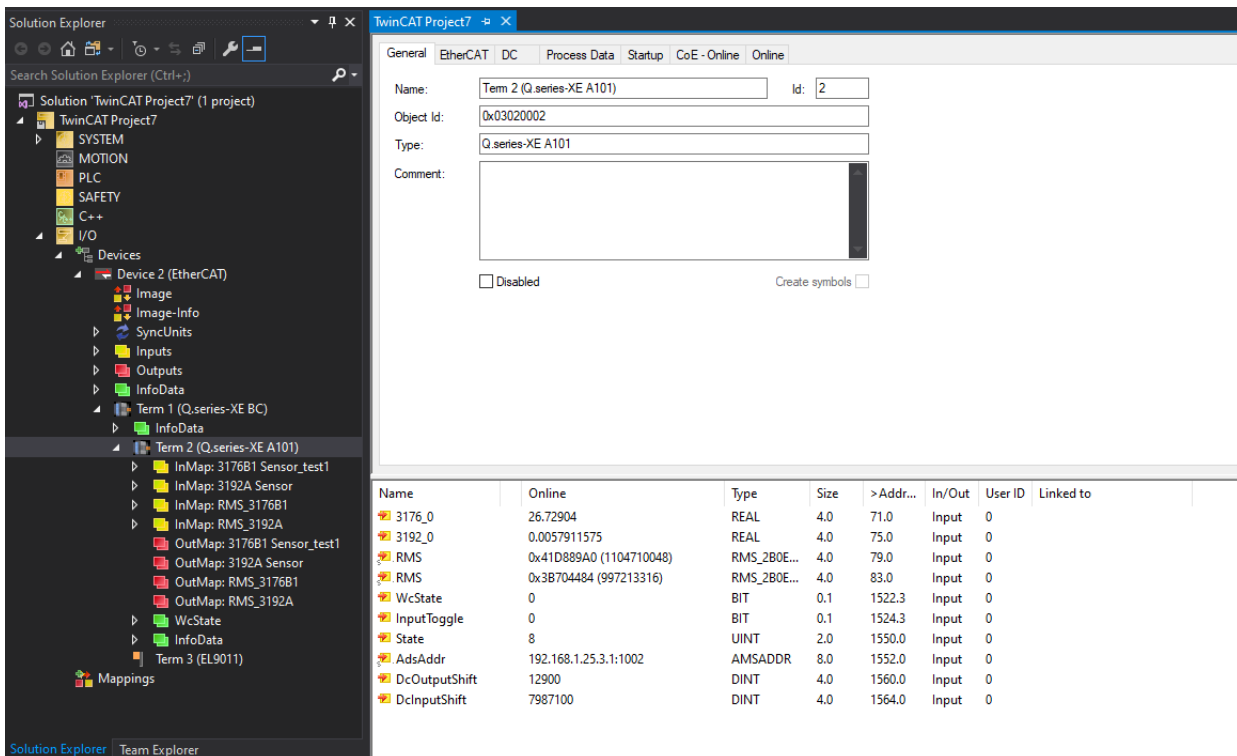

Fig. 6-29 Module(s) connected to the bus coupler.

To work with a device, you must first read the required information that defines the possible and actual settings of the modules.

1. Click on the desired module (e.g., Term 2) within the tree (Solution Explorer) and under the **CoE - Online** tab, click on **Advanced...** (see Fig. 6-31) to access settings.

If the **CoE - Online** tab is not available, in the menu, select **TwinCAT > Restart TwinCAT (Config Mode)** (Fig. 6-30).

Click **OK** when prompted to restart *TwinCAT* in Config Mode, click **Yes** when prompted to load I/O devices, and click **Yes** when prompted to activate *Free Run*.

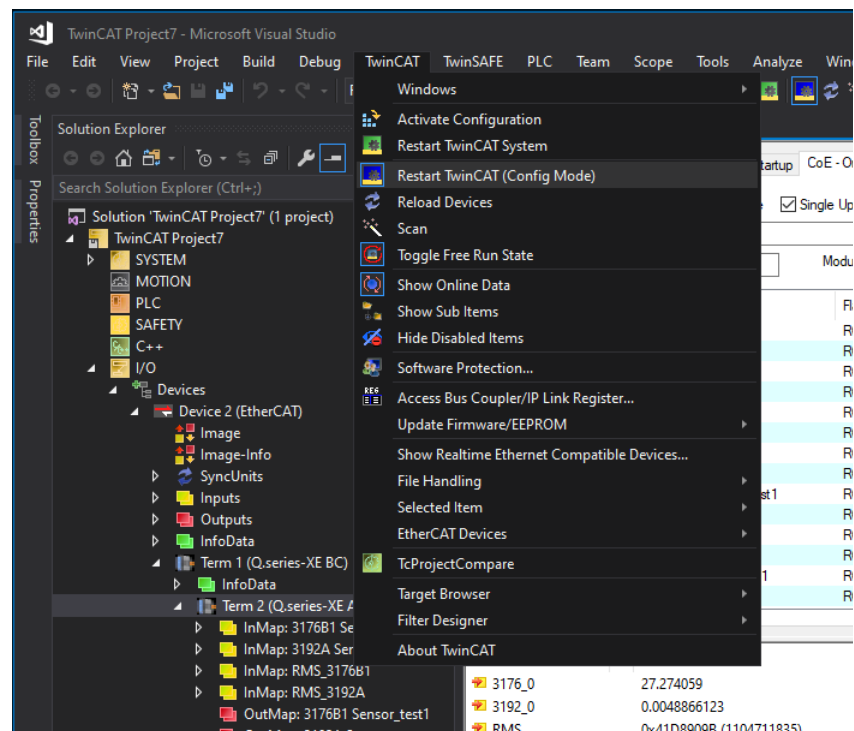

Fig. 6-30 Restarting TwinCAT in config mode for CoE - Online tab

2. In the dialog select **All Objects** and click on **OK** (Fig. 6-31).

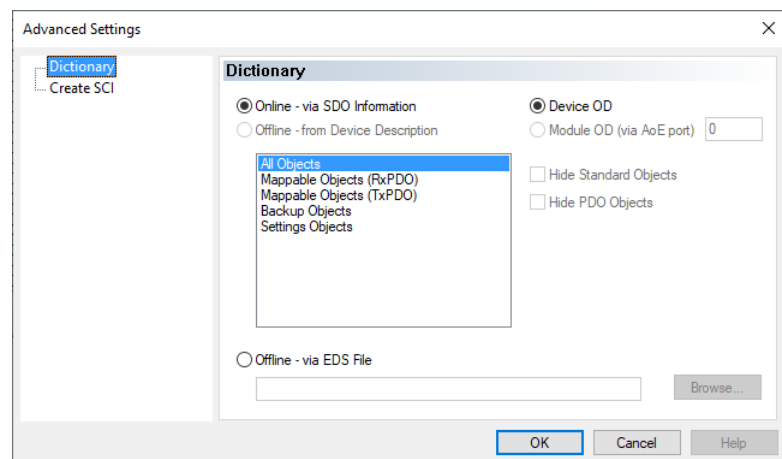

Fig. 6-31 Reading device information

TwinCAT will then read the required information and display a list of available settings. Double-click on an index to access the *Set Value Dialog* to make changes to settings (Fig. 6-32).

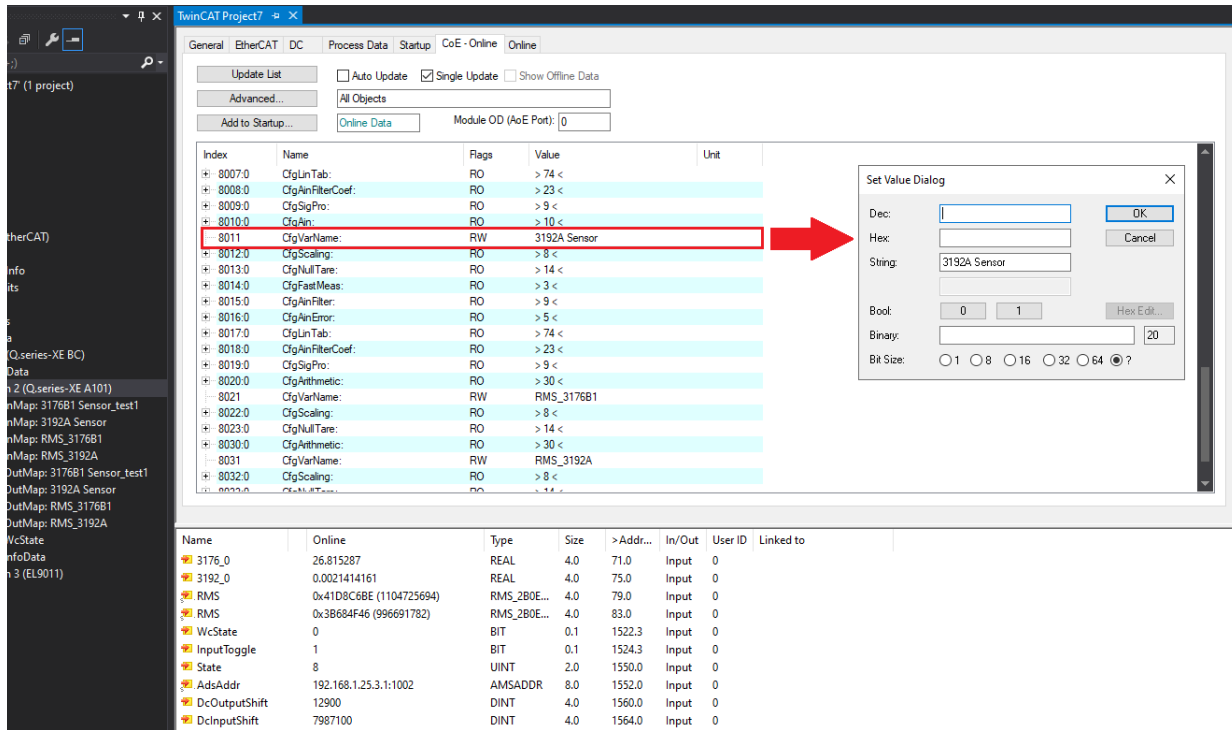

Fig. 6-32 Settings for Term 2 (Q.bloxx-XE A101) in TwinCAT

3. Repeat the previous steps for each module requiring changes.

6.12.4

Configuring Examples in *TwinCAT*

To configure the Q.series XE system, select the relevant module in the Solution Explorer and access the **CoE - Online** tab. Select the appropriate index to view and change the associated settings. Indexes are grouped into the following categories:

- 0 to 2000 onwards: System quantities
- 6000 onwards: Input quantities
- 7000 onwards: Output quantities
- 8000 onwards: Configuration SDOs
- A000 onwards: Status SDOs

The following examples demonstrate the configuration processes for strain gage sensors (force transducers) and thermocouples. When viewing the **CoE - Online** tab, configuration settings for the first analog input channel begin at index 8000. The second analog input channel begins at index 8010, and 8020 for the third one, etc. Open up the relevant index to view and change settings.

➔ After changing a setting, you must save it. Do this by calling the **StoreParameter** (index 1010); refer to Section 7, page 151.

6.12.4.1

Strain gage Force Transducer

In this example, the sensor is connected to Channel 1 (name: SG Force), therefore its configuration settings begin at index 8000. The setting for the sensor type (*MeasTyp*) is **Bridge** and the Wire setting is **full 6-wire** with a measurement range of 2.40mV/V.

The filter configuration can be found by expanding index 8005 as seen in Fig. 6-33, where a low pass with 499Hz (500Hz) is set.

Double-click on an index property to change it. For this example, to change the filter frequency, double-click on **LowF** (Fig. 6-34).

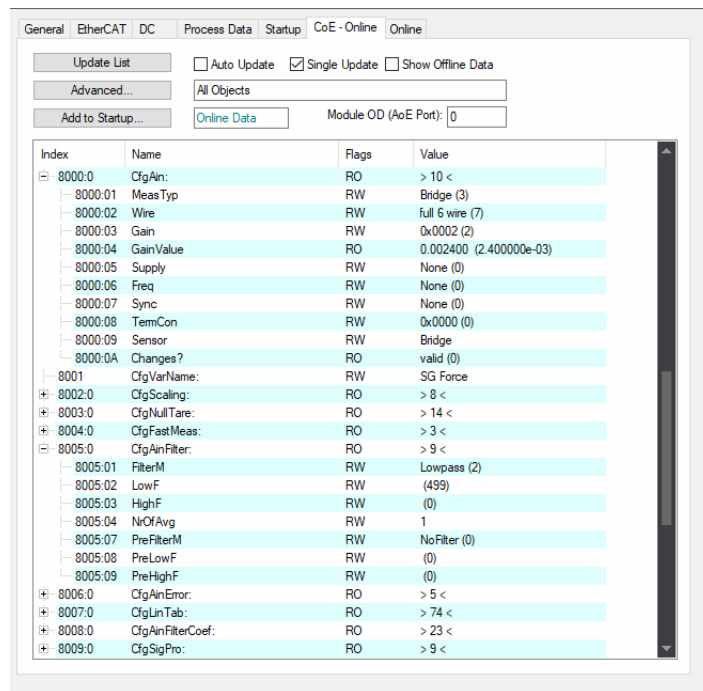

Fig. 6-33 Change settings for strain gage sensor on Channel 1

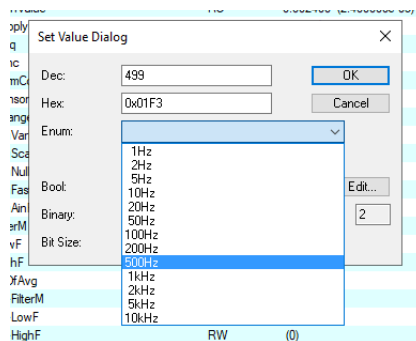

Fig. 6-34 Changing the value of the LowF filter frequency setting

6.12.4.2

Pt100

In this example, the sensor is connected to Channel 2 (name: Temperature); therefore its configuration settings begin at index 8010. The setting for Pt100 sensor type (*MeasTyp*) is **R** and the *Wire* is 4-wire (**R4wire**) with a measurement range of 400Ω.

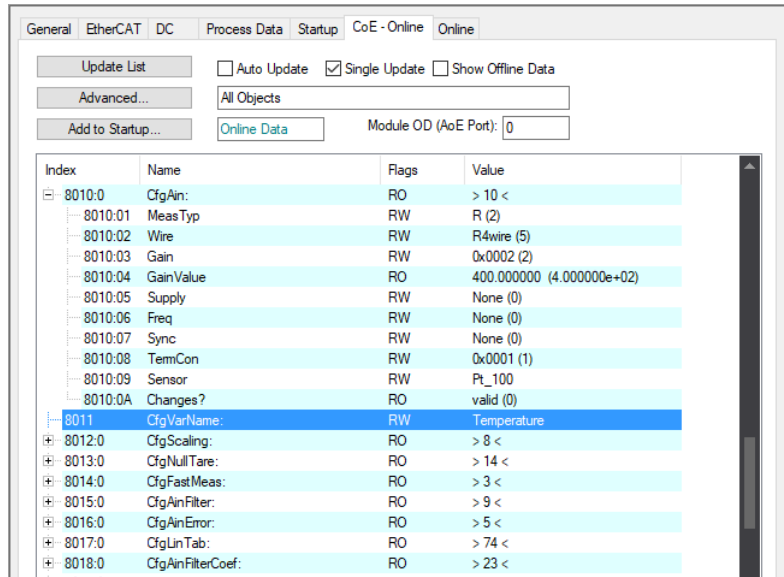

Fig. 6-35 Change settings for Pt100 sensor on Channel 2

6.12.5

Saving Configuration Changes in TwinCAT

To save changes made to settings, you must execute a special command (Index 1010: **StoreParameter**).

1. Under the **Online** tab, ensure that the relevant module is set to the “**Pre-Op**(erational)” *State Machine* setting (Fig. 6-36).

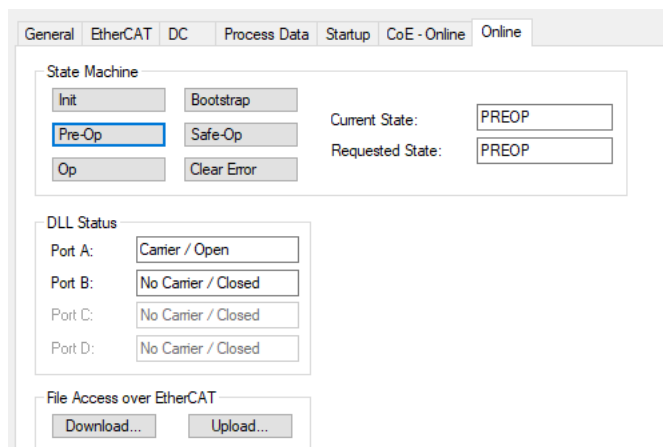

Fig. 6-36 Module in the “Pre-Operational” operating mode.

2. Click on the **CoE - Online** tab.

- Navigate to Index **1010:0 StoreParameter** and expand it in the tree to reveal the Index **1010:01 Initiator** (Fig. 6-37).

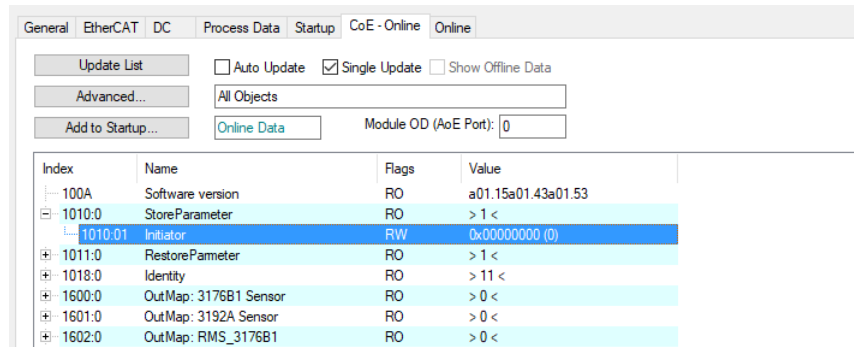

Fig. 6-37 Index 1010:01 Initiator (StoreParameter) selected.

- Double-click on the Index **1010:01 Initiator** to open the *Set Value Dialog* (Fig. 6-38).

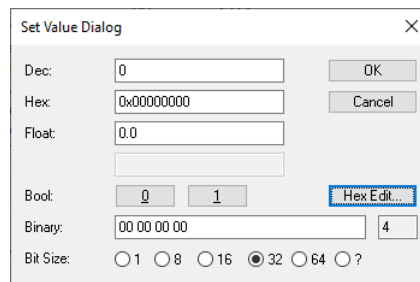

Fig. 6-38 Entering a value for saving.

- Click on **Hex Edit...** to enter the required command (if you know the values for the ASCII characters, you can enter them in the *Binary* field, but entry using the *Hex Edit* is easier).
- Enter the *UPPERCASE* letters **SAVE** on the right (Fig. 6-39).

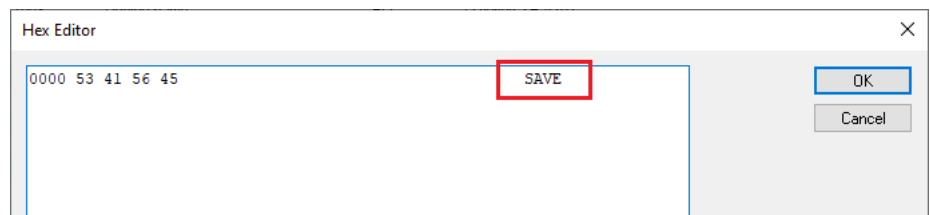

Fig. 6-39 Entering the SAVE command.

On the left, the hex equivalent for the letters *SAVE* appear.

- Close the *Hex Edit* and *Set Value* dialogs by clicking **OK**. The settings are saved and run after restarting the module(s).

6.12.6

Configuring the Distributed Clock (DC) in TwinCAT

The Q.series XE modules must always be set as *DC active* (default setting). You can check the setting by selecting a module and under the **DC** tab, click on **Advanced Settings** (Fig. 6-40).

! IMPORTANT

A common error when attempting to use a Q.series XE system is not having the *Distributed Clock (DC)* enabled in the EtherCAT master. The *Distributed Clock (DC)* must be enabled, otherwise the Q.series XE measurement modules will not work properly.

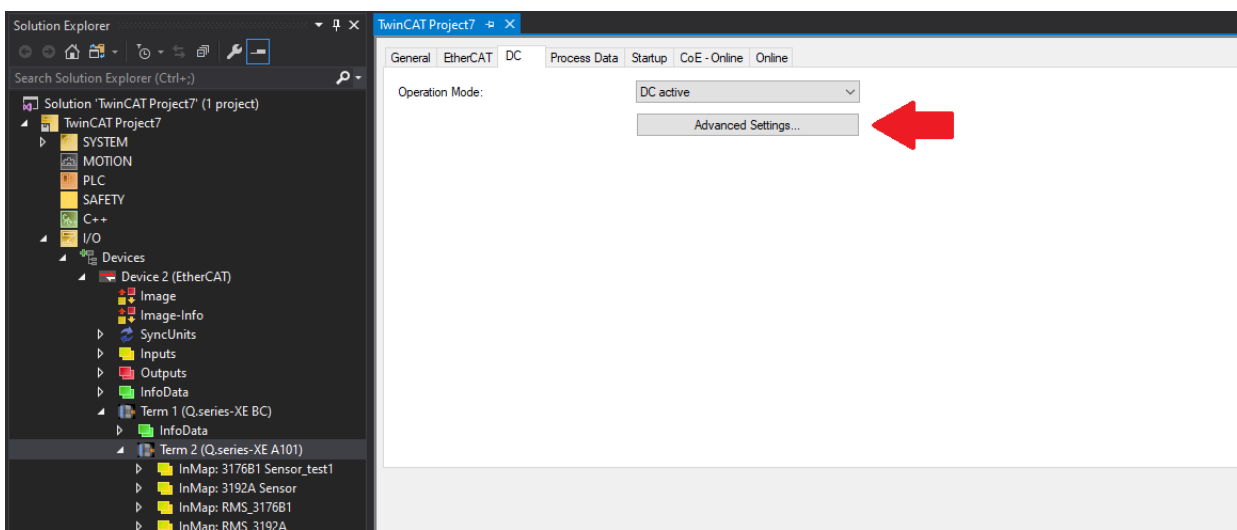

Fig. 6-40 Distributed clock Operation Mode settings

The Advanced Settings dialog (Fig. 6-41) shows all the settings regarding the distributed clock, changes are not necessary here.

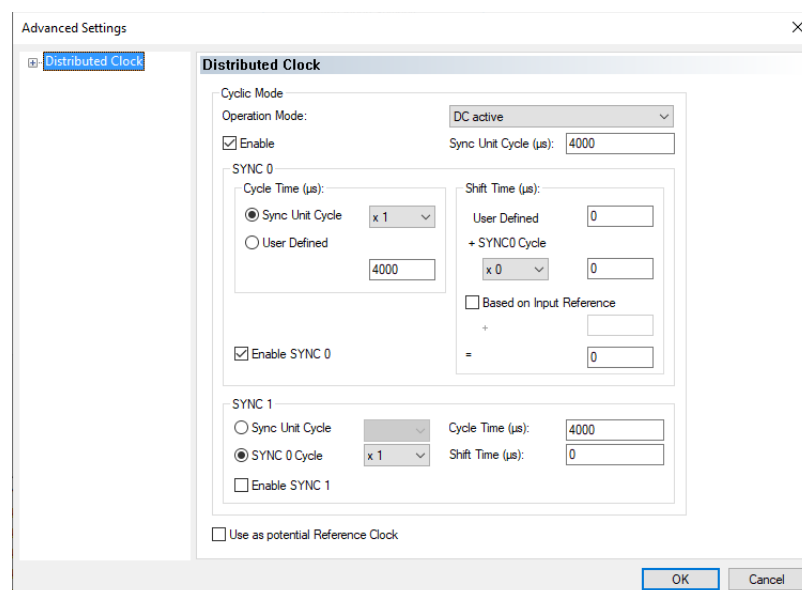

Fig. 6-41 Advanced Settings for Distributed Clock.

6.13

Q.series XE Module SDO Information

The SDOs (Service Data Objects) generated for different groups of channels are based on the information in the configuration file. These parameters are necessary to configure such channels. The following parameters can be changed by SDOs. The setup for the general module SDOs and analog input SDOs are described.

6.13.0.1

Groups of Service Data Objects (SDOs)

- General Module SDOs
- Analog Input Channel SDOs
- Analog Output Channel SDOs
- Digital Input Channel SDOs
- Digital Output Channel SDOs
- Arithmetic Channel SDOs
- Setpoint Channel SDOs
- Controller SDOs

6.13.0.2

Object Dictionary

Indexes of the object dictionary are divided into several function specific areas. The following tables show the used areas of the Modular-Device-Profile in Q.series XE modules.

Index	Object Dictionary Area	Description or Value
Enumeration Area		
0x0800 - 0x09FF	Different ENUMs	the enumerations used in the SDOs
EtherCAT Communication Area		
0x1000 - 0x1FFF	Communication Area	Standard communication area
Object Area of the Modules		
0x2000 - 0x5FFF	Manufacturer Specific Area	
0x6000 - 0x6FFF	Input Area	Objects that can be mapped to the TxPDOs
0x7000 - 0x7FFF	Output Area	Objects that can be mapped to the RxPDOs
0x8000 - 0x8FFF	Configuration Area	Configuration and setting objects
0x9000 - 0x9FFF	Information Area	Scanned information from the modules
0xA000 - 0xAFFF	Diagnosis Area	Diagnostic, status, statistic or other information
0xB000 - 0xBFFF	Service Transfer Area	Service Objects
Object Area of the Device		
0xC000 - 0xEFFF	Reserved Area	

6.13.0.3

Objects Generated for All Module Types

Index	Object Dictionary Area	Description or Value
EtherCAT Communication Area		
0x1000	Device Type	bit 15-0... 5001 MDP bit 31-16 0... no standardized profile
0x1001	Error Register	
0x1008	Device Name	Name of the device as a visible string
0x1009	Hardware Version	Hardware version as a visible string
0x100A	Software Version	Software version as a visible string
0x1010	Store Parameter	“SAVE” send as ASCII code, stores the configuration SDOs 800x to the configuration file on the module
0x1011	Restore Parameter	restores the default settings to the configuration SDOs 800x (not supported yet)
0x1018	Identity	Device information as defined in the EtherCAT standard
0x10F0	Backup Parameter	Shows that the checksum of the parameters has changed
0x10F1	Error Settings	
0x10F5	Diagnosis History	
0x1601	Output Mapping	list of the output PDOs
0x1A00	Input Mapping	list of the input PDOs
0x1C00	Sync Manager Type	For a modular device profile the use of the Sync Manager Channels 0-3 is fixed
0x1C12	RxPDO assign	PDO assignment for the data sent from master to module
0x1C13	TxPDO assign	PDO assignment for the data sent from module to master
EtherCAT Vendor Specific Area		
0x2000	Md5 CRC	checksums of configuration-, interface-, and calibration-file
0x2001	Status information module	Module, Variables, Load, System
0x2002	SW version Release/Working	Last official version, current, state, date
0x2003	Module Type Information available in different files	calibration-file-, configuration-, and interface-info of both module-EE and socket-EE
0x2004	Module configuration	Shows the types of the configured variables
0x2005	File download status	shows the current status of the last received file
0x2010	Threshold (digital input)	D101, A109 change between TTL and SPS thresholds
0x2011	Identify	the LEDs can be turned on flashing
Object Area of the Modules		
Input Data of the Module		
0x6000	Input Data Channel 1	Objects that can be mapped to the TxPDOs
0x6010	Input Data Channel 2	Objects that can be mapped to the TxPDOs

Output Data of the Modules		
0x7000	Output Data Channel 1	Objects that can be mapped to the RxPDOs
0x7010	Output Data Channel 2	Objects that can be mapped to the RxPDOs
Configuration Data of the Module		
0x8000	Configuration Channel 1	Configuration
0x8010	Configuration Channel 2	Configuration
Diagnostic, Status, Statistic or other information of the Modules		
0xA000	Status Flags Channel 1	Range error, Overload, A.S.O.
0xA010	Status Flags Channel 2	Range error, Overload, A.S.O.

6.13.0.4

EtherCAT Vendor Specific Area

Index	Object Dictionary Area	Description / Value
0x2000	Md5 CRC	checksums of configuration-, interface-, and calibration-file
0x2001	Status information module	Module, Variables, Load, System
0x2002	SW version Release/Working	Last official version, current, state, date
0x2003	Module Type Information available in different files	calibration-file-, configuration-, and interface-info of both module-EE and socket-EE
0x2004	Module configuration	Shows the types of the configured variables
0x2005	File download status	shows the current status of the last received file
0x2010	Threshold (digital input)	D101, A109 change between TTL and SPS thresholds
0x2011	Identify	the LEDs can be turned on flashing

Index	SubIndex	Type	Value	Description
0x2000	0	INT8	3	SubIndex0 of Md5 CRC SDO
	1	STRING	...	hex code, config. file CRC
	2	STRING	...	hex code, interface file CRC
	3	STRING	...	hex code, calibration file Md5 CRC
0x2001	0	INT8	3	SubIndex0 status information
	1	INT32	...	module status word
	2	INT32	...	variable range error word
	3	INT32	...	load status system
	4	INT32	...	file status EE
	5	INT32	...	load RAM
	6	INT32	...	file status RAM
0x2002	0	INT8	3	SubIndex0 of SW version Release/Working
	1	STRING	...	last used official release
	2	STRING	...	working release number/code
	3	STRING	...	working/release
	4	STRING	...	release date and time
	5	STRING	...	XML version valid for this firmware

0x2003	0	INT8	20	SubIndex0 File Type Info	
	1	STRING	...	Calibration File ModTy	
	2	STRING	...	Calibration File SModTy	
	3	STRING	...	Calibration File CaTy	
	4	STRING	...	Module Software FuTy	
	5	STRING	...	Interface File ModTy	
	6	STRING	...	Interface File SModTy	
	7	STRING	...	Interface File CaTy	
	8	STRING	...	Interface File FuTy	
	9	STRING	...	Configuration File ModTy	
	A	STRING	...	Configuration File SModTy	
	B	STRING	...	Configuration File CaTy	
	C	STRING	...	Configuration File FuTy	
	D	STRING	...	Socket Interface File ModTy	
	E	STRING	...	Socket Interface File SModTy	
	F	STRING	...	Socket Interface File CaTy	
	10	STRING	...	Socket Interface File FuTy	
	11	STRING	...	Socket Configuration File ModTy	
	12	STRING	...	Socket Configuration File SModTy	
	13	STRING	...	Socket Configuration File CaTy	
	24	STRING	...	Socket Configuration File FuTy	
	0x2004	0	INT16	3	SubIndex0 File Module Configuration
		1	INT16	...	Variable Count, number of configurable variables
		2	INT16	...	Max Number of Ain
3		INT16	...	Max Number of Aout	
4		INT16	...	Max Number of Din	
5		INT16	...	Max Number of Dout	
6		INT16	...	Max Number of Setpoints	
7		INT16	...	Max Number of Signalcond	
8		INT16	...	Max Number of Alarm	
9		INT16	...	type of V[0]	
A		INT16	...	type of V[1]	
B		INT16	...	type of V[2]	
C		INT16	...	type of V[3]	
D		INT16	...	type of V[4]	
E		INT16	...	type of V[5]	
F		INT16	...	type of V[6]	
10		INT16	...	type of V[7]	
11		INT16	...	type of V[8]	
12		INT16	...	type of V[9]	
13		INT16	...	type of V[10]	
24		INT16	...	type of V[11]	
25		INT16	...	type of V[12]	
26		INT16	...	type of V[13]	
27		INT16	...	type of V[14]	

0x2005	0	INT16	5	SubIndex0 File Download Status
	1	0x8B7	...	what is done right now with the file
	2	0x8B5	...	received file status
	3	Uint32	...	length of the received file
	4	0x8B6	...	received file type
	5	STRING	...	name of the received file
0x2010	0	INT16	2	SubIndex0 threshold configuration
	1	INT16	...	Threshold Connector 1
	2	INT16	...	Threshold Connector 2
0x2011	0	INT16	1	SubIndex0 Identity
	1	0x8B4	...	LED Flashing

6.13.0.5

Analog Input Configuration SDOs

The configuration SDOs below apply to channel 1 of a module. Channels beyond that have indexes of $(0x800x + Ch_Nr * 0x10)$.

Index	SubIndex	Type	Value	Description
0x8000	0	INT8	10	Index0 of the analog input multiplexer config.
	1	ENUM830	Section 7.5.2.4, page 162	Measure Type (U, I, R,...)
	2	ENUM831	Section 7.5.2.5, page 162	Wire Type (single, differential,...)
	3	UINT16	0-9	Gain selection
	4	FLOAT32	e.g. 10.0	Measure range
	5	ENUM832	Section 7.5.2.6, page 163	Bridge Supply
	6	ENUM833	Section 7.5.2.7, page 163	Bridge supply frequency (DC, 600Hz, 4800Hz)
	7	ENUM834	Section 7.5.2.8, page 163	Sync Type (internal, external, none)
	8	UINT16	0...n	First terminal connector of the analog input
	9	STRING	e.g. Voltage	Name of the sensor
	A	ENUM835	Section 7.5.2.9, page 163	Value changed but configuration not stored
0x8001	0	STRING	"Variable 1"	Name of the channel
0x8002	0	UINT16	8	Index0 of the scaling SDO
	1	ENUM862	Section 7.5.5.3, page 165	Data direction (input, output,...)
	2	ENUM861	Section 7.5.5.2, page 165	Data type (int16, int32, float)
	3	STRING	Unit	Units
	4	UINT16	DaPr	Data Precision
	5	FLOAT32	UnTrOf	Unit Transformation Offset
	6	FLOAT32	UnTrFa	Unit Transformation Factor
	7	FLOAT32	ScaOf	Scaling Transformation Offset
	8	FLOAT32	ScaFa	Scaling Transformation Factor

0x8003	0	UINT16	C	Index0 of the null-tare SDO
	1	ENUM840	Section 7.5.3.1, page 164	Source of null (host, Din, on-variable)
	2	ENUM841	Section 7.5.3.2, page 164	Activate the null function through SDO, not part of the configuration file
	3	UINT16	ZeroTInd	Number of digital input null source
	4	ENUM840	Section 7.5.3.1, page 164	Source of tare (host, Din, on-variable)
	5	ENUM841	Section 7.5.3.2, page 164	Activate the tare function through SDO, not part of the configuration file
	6	UINT16	TareTInd	Number of digital input tare source
	7	ENUM840	Section 7.5.3.1, page 164	Source of shunt (host, Din, On-variable)
	8	ENUM841	Section 7.5.3.2, page 164	Activate the shunt function through SDO, not part of the configuration file
	9	UINT16	ShuntTInd	Number of digital input Shunt source
	A	UINT16	NullVInd	Number of variable as null source
	B	UINT16	TareVInd	Number of variable tare source
	C	UINT16	ShuntVInd	Number of variable shunt source
0x8004	0	UINT16	3	Index0 of the fast measure SDO
	1	ENUM805	Section 7.5.1.2, page 160	Oversampling mode (off, oversampling, async-buffer)
	2	ENUM80A	Section 7.5.1.3, page 160	Effective adjusted sample frequency
	3	UINT16	1...100	Number of samples per channel
0x8005	0	INT8	4	Index0 of the filter configuration SDO
	1	ENUM820	Section 7.5.2.1, page 161	List of filter modes (arithmetic, lowpass,...)
	2	ENUM821	Section 7.5.2.2, page 161	LP Filter frequencies supported by module
	3	ENUM822	Section 7.5.2.3, page 162	HP Filter frequencies supported by module
	4	UINT16	0...n	Number of average
0x8006	0	INT8	4	Index0 of the error configuration SDO
	1	ENUM870	Section 7.5.5.4, page 165	List of error modes (min & max values, corresponding limits, default value)
	2	FLOAT	xxx	default value used for that failure mode
	3	FLOAT	xxx	minimal output value
	4	FLOAT	xxx	maximal output value
0x8007	0	INT8	4	Index0 of the linearization SDO
	1	ENUM836	Section 7.5.2.10, page 163	List of present linearization curves
	2	Uint16	xxx	Number of linearization points
	3	FLOAT	xxx	Min x value in the file
	4	FLOAT	xxx	Max x value in the file
	5	FLOAT	xxx	Min y value in the file
	6	FLOAT	xxx	Max y value in the file
	7	FLOAT	xxx	Min x value
	8	FLOAT	xxx	Max x value
	9	FLOAT	xxx	Min y value
	10	FLOAT	xxx	Max y value
	11...42	FLOAT	xxx	X [0...31]
	43...74	FLOAT	xxx	Y [0...31]

6.13.0.6

Diagnostic, Status, Statistic or Other Information of Modules

Index	SubIndex	Type	Value	Description
0xA000	0	UINT16	5	Index0 of the Status flags SDO
	1	BOOLEAN	true, false	overflow of channel x active
	2	BOOLEAN	true, false	underflow of channel x active
	3	BOOLEAN	true, false	PDOs of channel x changed (PDO mapping must be reloaded)
	4	BOOLEAN	true, false	SDOs of channel x changed (SDOs include data which is not stored to the EE)
	5			empty bits to fill up to a word

6.13.0.7

Analog Output Configuration SDOs

The configuration SDOs below apply to channel 1 of a module. Channels beyond that have indexes of (0x800x + Ch_Nr * 0x10).

Index	SubIndex	Type	Value	Description
0x8000	0	UINT16	5	Index0 of the digital output configuration SDO
	1	ENUM8A0	Section 7.5.8.1, page 168	Analog output type (current, voltage)
	2	ENUM8A2	Section 7.5.8.3, page 168	Used filter (only A102)
	5	UINT16	SrcVar	the number of the variable used as source
	3	ENUM8A1	Section 7.5.8.2, page 168	Defines the source of the analog output value
	4	UINT16	SrcPar0	Used depending on the SrcVInd
	5	UINT16	SrcPar1	Used depending on the SrcVInd
	6	FLOAT32	WatchTimoDef	Startup value
	7	FLOAT32	MinValSrc	X [0]
	8	FLOAT32	MaxValSrc	X [1]
	9	FLOAT32	MinValOut	Y [0]
10	FLOAT32	MaxValOut	Y [1]	
0x8001	0	STRING	Na	Name of the channel ("Variable 1")
0x8002	0	UINT16	9	Index0 of the scaling SDO
	1	ENUM862	Section 7.5.5.3, page 165	Data direction (input, output,...)
	2	EMPTY	0	Empty 8 bits to get 16bit aligned
	3	ENUM861	Section 7.5.5.2, page 165	Data type (int16, int32, float)
	4	STRING	DaUn	string shows the unit
	5	UINT16	DaPr	data precision (0...7)
	6	FLOAT32	UnTrOf	Unit Transformation Offset
	7	FLOAT32	UnTrFa	Unit Transformation Factor
	8	FLOAT32	ScaOf	Scaling Transformation Offset
9	FLOAT32	ScaFa	Scaling Transformation Factor	
0x8005	0	UINT16	2	Index0 of the timeout SDO
	1	ENUM8A3	Section 7.5.7.4, page 167	Timeout behavior (last value, default value)
	2	FLOAT32	WatchTimoDef	Default value used for startup and communication timeout (if certain mode is configured)

6.13.0.8

Digital Input Configuration SDOs

The configuration SDOs below apply to channel 1 of a module.
Channels beyond that have indexes of (0x800x + Ch_Nr * 0x10).

Index	SubIndex	Type	Value	Description
0x8000	0	UINT16	7	Index0 of the digital input configuration SDO
	1	ENUM880	Section 7.5.6.1, page 166	Measure Type (time, frequency, PWM)
	2	ENUM881	Section 7.5.6.2, page 166	Subdivision of the measurement
	3	ENUM882	Section 7.5.6.3, page 166	Number of used pins
	4	ENUM883	Section 7.5.6.4, page 166	Detected Edges (not_def, rising, falling, both)
	5	FLOAT32	1ms...10ms	Timebase
	6	UINT16	0...15	First terminal connector of the digital input
	7	ENUM852	Section 7.5.2.11, page 164	A value has changed but configuration is not been stored
0x8001	0	STRING	"Variable 1"	Name of the channel ("Variable 1")
0x8002	0	UINT16	9	Index0 of the scaling SDO
	1	ENUM862	Section 7.5.5.3, page 165	Data direction (input, output,...)
	2	EMPTY	0	Empty 8 bits to get 16bit aligned
	3	ENUM861	Section 7.5.5.2, page 165	Data type (int16, int32, float)
	4	ENUM860	Section 7.5.5.1, page 165	some predefined units
	5	UINT16	DaPr	data precision (0...7)
	6	FLOAT32	UnTrOf	Unit Transformation Offset
	7	FLOAT32	UnTrFa	Unit Transformation Factor
	8	FLOAT32	ScaOf	Scaling Transformation Offset
	9	FLOAT32	ScaFa	Scaling Transformation Factor
0x8003	0	UINT16	C	Index0 of the null-tare SDO
	1	ENUM840	Section 7.5.3.1, page 164	Source of tare (host, Din, on-variable)
	2	ENUM841	Section 7.5.3.2, page 164	Activate the null function through SDO, not part of the configuration file
	3	UINT16	ZeroTInd	Number of digital input null source
	4	ENUM840	Section 7.5.3.1, page 164	Source of tare (host, Din, on-variable)
	5	ENUM841	Section 7.5.3.2, page 164	Activate the tare function through SDO, not part of the configuration file
	6	UINT16	TareTInd	Number of digital input tare source
	7	ENUM840	Section 7.5.3.1, page 164	Source of Shunt (host, Din, on-variable)
	8	ENUM841	Section 7.5.3.2, page 164	Activate the shunt function through SDO, not part of the configuration file
	9	UINT16	ShuntTInd	Number of digital input Shunt source
	A	UINT16	NullVInd	Number of variable as null source
	B	UINT16	TareVInd	Number of variable tare source
	C	UINT16	ShuntInd	Number of variable shunt source

0x8004	0	UINT16	3	Index0 of the fast measure SDO
	1	ENUM805	Section 7.5.1.2, page 160	Oversampling Mode (off, oversampling, async-buffer)
	2	ENUM80A	Section 7.5.1.3, page 160	Effective adjusted sample frequency
	3	UINT16	1...100	Number of samples per channel
0x8005	0	UINT16	5	Index0 of the threshold configuration SDO
	1	ENUM884	Section 7.5.6.5, page 167	Digital Input Type (differential, single-ended)
	2	UINT16	0	Type of digital input (CMOS, TTL,...) not supported
	3	FLOAT32	-24.0 ... +24.0	High level threshold
	4	FLOAT32	-24.0 ... +24.0	Low level threshold
	5	UINT16	1...256	Prescaler of the digital input

6.13.0.9

Digital Output Configuration SDOs

The configuration SDOs below apply to channel 1 of a module. Channels beyond that have indexes of (0x800x + Ch_Nr * 0x10).

Index	SubIndex	Type	Value	Description
0x8000	0	UINT16	7	Index0 of the digital output configuration SDO
	1	ENUM890	Section 7.5.7.1, page 167	Measure Type (time, frequency, PWM)
	2	ENUM891	Section 7.5.7.2, page 167	Subdivision of the digital output configuration
	3	ENUM892	Section 7.5.7.3, page 167	not used
	4	FLOAT32	0-100%	PWM constant
	5	FLOAT32	0-10000Hz	Frequency constant
	6	UINT16	TeCo	First terminal connector of the digital output (0...15)
	7	ENUM852	Section 7.5.2.11, page 164	A value has changed but the configuration has not been stored
0x8001	0	STRING	Na	Name of the channel ("Variable 1")
0x8002	0	UINT16	9	Index0 of the scaling SDO
	1	ENUM862	Section 7.5.5.3, page 165	Data direction (Input, Output,...)
	2	EMPTY	0	Empty 8 bits to get 16bit aligned
	3	ENUM861	Section 7.5.5.2, page 165	Data type (INT16, INT32, FLOAT)
	4	ENUM860	Section 7.5.5.1, page 165	Some predefined Units
	5	UINT16	DaPr	Data precision (0...7)
	6	FLOAT32	UnTrOf	Unit transformation Offset
	7	FLOAT32	UnTrFa	Unit transformation Factor
	8	FLOAT32	ScaOf	Scaling Transformation Offset
	9	FLOAT32	ScaFa	Scaling Transformation Factor
0x8005	0	UINT16	C	Index0 of the timeout SDO
	1	ENUM8A3	Section 7.5.7.4, page 167	Timeout behavior (last value, default value)
	2	FLOAT32	WatchTimoDef	not used for the digital output, default values are used, configured in the 0x8000 SDO

0x8006	0	UNIT16	16	Index0 of the FreqPWM scaling SDO
	1	FLOAT32	F_MinValSrc	Min Input Value
	2	FLOAT32	F_MaxValSrc	Max Input Value
	3	FLOAT32	F_MinValOut	Min Output Value
	4	FLOAT32	F_MaxValOut	Max Output Value
	5	FLOAT32	F_Uflow	Underflow Value
	6	FLOAT32	F_Oflow	Overflow Value
	7	FLOAT32	Offset	Offset out of the upper 2 point linearization (read only)
	8	FLOAT32	Factor	Factor out of the upper 2 point linearization (read only)
	9	FLOAT32	P_MinValSrc	Min Input Value
	A	FLOAT32	P_MaxValSrc	Max Input Value
	B	FLOAT32	P_MinValOut	Min Output Value
	C	FLOAT32	P_MaxValOut	Max Output Value
	D	FLOAT32	P_Uflow	Underflow Value
	E	FLOAT32	P_Oflow	Overflow Value
F	FLOAT32	Offset	Offset out of the upper 2 point linearization (read only)	
10	FLOAT32	Factor	Factor out of the upper 2 point linearization (read only)	
0x8006	0	UINT16	10	Index0 of the frequency and ratio source configuration SDO
	1	ENUM08B3	Section 7.5.8.7, page 169	Source frequency variable number (-2...constant value)
	2	ENUM08B2	Section 7.5.8.6, page 169	Output type (read only)
	3	UINT16		SrcFreqPar0 subselection (read only)
	4	UINT16		SrcFreqPar1 subselection (read only)
	5	UINT32		Address of frequency source (read only)
	6	ENUM08B3	Section 7.5.8.7, page 169	Source ratio variable number (-2...constant value)
	7	ENUM08B2	Section 7.5.8.6, page 169	Output type (read only)
	8	UINT16		SrcRatioPar0 subselection (read only)
	9	UINT16		SrcRatioPar1 subselection (read only)
	A	UINT32		Address of ratio source (read only)

7

Appendix

In this chapter you will find explanations on the application of sensors. The setting dialogs in the illustrations are the dialogs displayed in the GI.bench program.

7.1

Connecting Transducers with Sensing Leads

Resistive sensors require an excitation voltage to output a signal. In order for sensor excitation to occur, a current must pass through the connecting cable. This however causes a loss of voltage proportional to the length of the cable due to the resistance within the cable. In this situation, the connected sensor is typically not supplied with the exact voltage set on the connected amplifier module but more often with a slightly lower voltage due to voltage losses over the length of the cable used. This results in a lower output signal from the sensor and depending on the cable's resistance, can result in measurement losses within the single-figure percentage range even when using just a few meters of cable.

High quality amplifier modules for the excitation of resistive sensors utilize sensing leads which can measure the loss of voltage over the length of the cable due to the low current flowing through them. This is due to the inputs on the sensing leads typically having high input resistances (usually over $10^6 \Omega$ compared to a typical sensor's resistance of a few 100Ω). Therefore, such amplifier modules can acquire the voltage arriving at the sensor error-free and increase their excitation voltage to compensate for the voltage loss due to cable resistance. These sensing leads are particularly necessary when the temperature of the connected cable can change throughout a measurement. In this situation, the cable resistance changes during a measurement as well and in turn the sensor output signal would also change if no sensing leads were used.

We therefore strongly recommend the use of sensing leads for use with sensors that require an excitation voltage in order to output a signal. They are especially necessary when several meters of cable are expected to be used in your application, if low measurement deviations are expected to be obtained or if the temperature of the cable may vary during measurement.

7.2

Sensor Scaling in GI.bench

Depending on the type of transducer (or sensor) used, there are various possible scaling configuration options available to you. For voltage signals and strain gages (bridges), you may define the conversion of the measured voltage signal (V or mV/V) into an available physical unit of your choosing, e.g. Newtons, from the drop down menu in the **Unit** field. A list of the available units in *GI.bench*, refer to Section 7.2.3, page 155.

The units for any measurement can be changed and scaled freely in *GI.bench*, i.e. any custom unit with a digit length of 6 or less characters is valid. Simply type the desired custom designation in the **Unit** field under the **Scaling** category in the *Variable settings* window in *GI.bench*. In the case of strain gages, a special tool called the **Strain Gage calculator** is also available to you (e.g., Fig. 7-3, page 154). Refer to Section 7.2.2, page 154 for more information regarding the **Strain Gage calculator**.

In *GI.bench*, right-click on the variable that requires scaling and select **Edit variable** to open the variable settings window (refer to Fig. 7-1 below. Alternatively, double click on the variable.

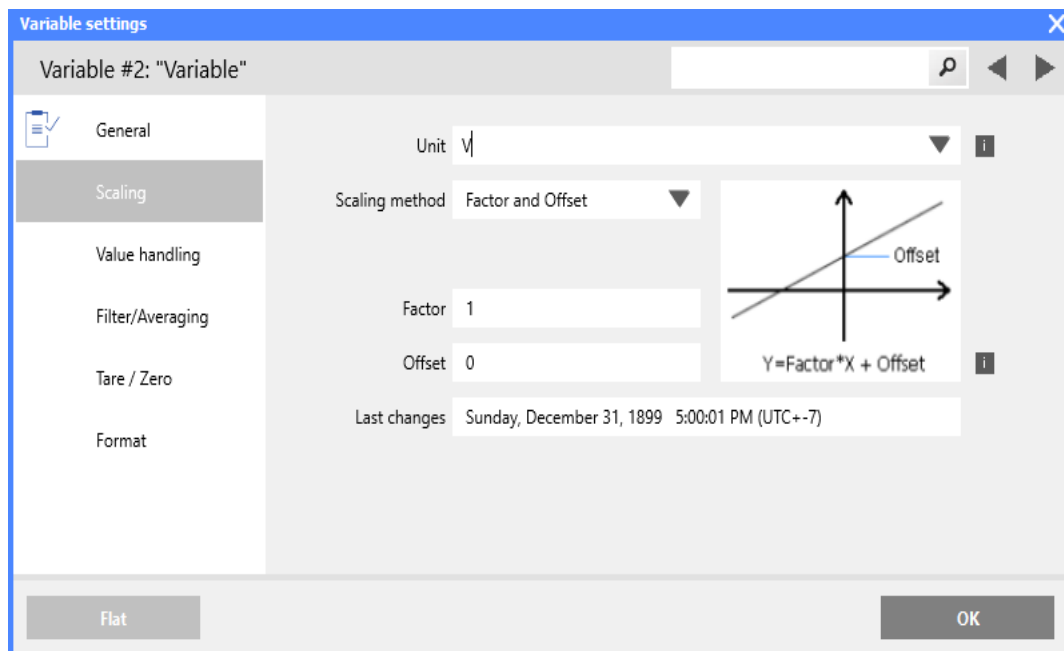

Fig. 7-1 Scaling options for voltage using Factor and Offset

7.2.1

Scaling Voltage Signals and Strain Gage Bridges

1. In the **Scaling** options of the *Variable settings* window in *GI.bench*, there is a **Unit** field where you can define a required physical unit, e.g. **N**. The units available via the drop down menu may be limited to selections of scaled variants of the base unit of the **Analog input type** defined in the **General** options. Access available units by clicking on the down arrow in the **Unit** field. If the unit you desire is not available, enter the desired unit nomenclature manually into the **Unit** field. Nomenclature is limited to 6 characters or less in length. After defining a unit in this fashion, the Scaling options will be refreshed to **Factor and Offset** method if changed previously. Select desired **Scaling method** if desired.
2. In the **Scaling** options of the *Variable settings* window in *GI.bench*, you may define **Factor** and **Offset** if specified by your sensor. Keep in mind, the values defined in **Factor** and **Offset** will dynamically influence the values for **Minimum** and **Maximum** defined within the **Value Handling** options of the *Variable settings* window.
3. In the **Scaling** options of the *Variable settings* window in *GI.bench*, you may enter a transducer's (sensor's) calibration data from a respective calibration certificate or data sheet (e.g., refer to Fig. 7-2, page 153) using **2 Point calculator** as the **Scaling Method**.

You may define scaling in both of the positive and negative directions, however, you can alternatively define scaling in just one direction. To do this, enter "0" for **Input [A]** and **Output [B]** at **Point 1**, where *A* and *B* represent the base voltage unit (e.g. V) and desired unit (e.g. N), respectively. Please note, changes made within the **Scaling** menu will also influence the values for **Minimum** and **Maximum** defined within the **Value Handling** options in *Variable Settings*.

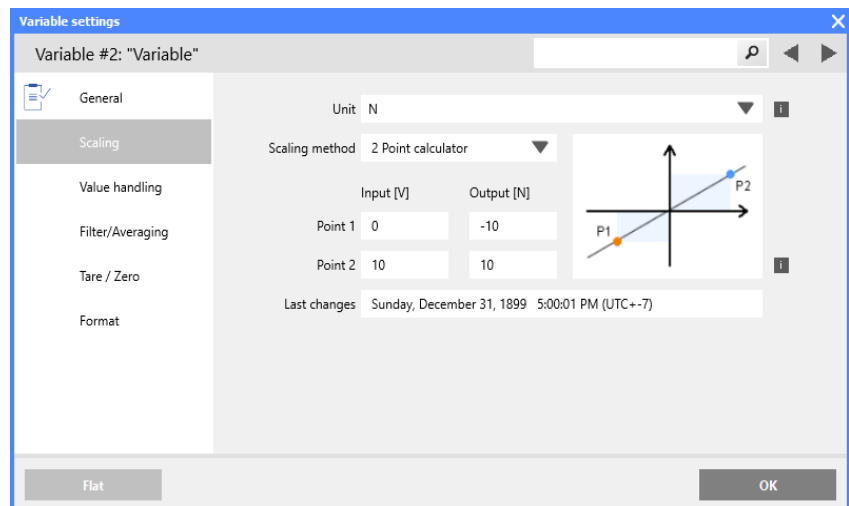

Fig. 7-2 Scaling options for voltage using 2 Point calculator

7.2.2

Scaling with Strain Gage Calculator

1. In the **Scaling** options of the *Variable settings* window, define the **Scaling method** as **Strain Gage calculator**. This will allow you to define the **Bridge Polarity**, **k Factor** and **Bridge Factor (B)** for your bridge sensor.
2. Enter the *gauge factor (k Factor)* of your strain gage in the provided field.
The *gauge factor* is a measure of the sensitivity of the strain gage and is stated on each strain gage sensor. It is usually between 1.8 and 2.2. Fig. 7-3 shows scaling with $k = 2$.
3. If you are using more than one active strain gage in your bridge circuit you may need to define the **Bridge Factor (B)** in the provided field. Additional details available below.
4. After clicking **OK** with *Strain Gage calculator* as the scaling method, the unit for the variable is automatically changed to $\mu\text{m/m}$.

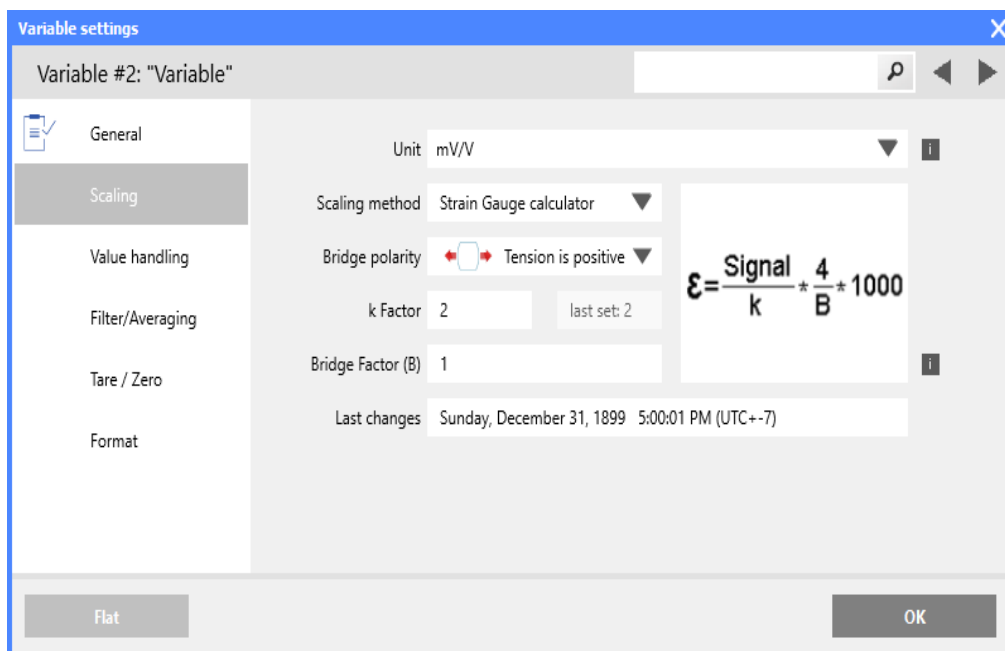

Fig. 7-3 Strain Gage calculator for scaling bridge inputs

The number of active arms in a strain gage (Wheatstone bridge) is known as the *bridge factor*. If a bridge factor is known, use that value. Otherwise, as a simple guide when selecting bridge factors, the following rules *may* apply when the strain gages are configured in a particular way:

- When using 1/4 bridge completion the bridge factor should be set to 1
- When using 1/2 bridge completion the bridge factor should be set to 2
- When using full bridge completion the bridge factor should be set to 4

Bridge factor depends on the orientation of the strain gage on the measurement object and, where applicable, also depends on the Poisson's ratio for the materials used. E.g., if strain gages are mounted in a transverse configuration for temperature compensation, then different, more complex rules likely apply.

We recommend, due to the nature of the small changes in voltage that are associated with strain gage measurements, all changes to the amplifier gain or the excitation voltage should be followed by a calibration.

7.2.3

Available Units *GI.bench*

The following is a list of the physical quantities and associated units available in *GI.bench*. The units for any measurement can be changed and scaled freely in *GI.bench*, i.e. any custom unit with a digit length of 6 or less characters is valid. Simply type the desired custom designation in the **Unit** field under the **Scaling** category in the *Variable settings* window in *GI.bench*. The **Factor** and **Offset** for each unit is listed below in the same order.

When creating a custom unit, ensure that the proper **Factor** and **Offset** are used. Alternatively, **2 Point calculator** is available as a **Scaling method**. The units listed below can be scaled this way if selected where *Input [...]* is the base unit and *Output [...]* is the custom unit. Adjust scaling as needed for **Point 1** and **Point 2**.

For each physical quantity below, the unit(s) in bold correspond to a **Factor** of **1** and **Offset** of **0**, i.e. *base units*. All other units within the same physical quantity (i.e., units not in bold) use a combination of factor and offset to scale the base unit as needed.

Physical Quantity	Default Units and Scaling Available in <i>GI.bench</i>
Acceleration	m/s²
Factor	1
Offset	0
Angle	deg, rad
Factor	1, 1.74532925199433x10⁻²
Offset	0, 0
Bridge	V/V, mV/V, μV/V
Factor	1, 1000, 1x10⁶
Offset	0, 0, 0
Charge	C, pC, nC, μC, mC
Factor	1, 1x10¹², 1x10⁹, 1x10⁶, 1000
Offset	0, 0, 0, 0, 0

Counter	times
Factor	1
Offset	0
Current	A, μA, mA, kA
Factor	1, 1x10⁶, 1000, 0.001
Offset	0, 0, 0, 0
Distance	m, μm, mm, cm, dm, km, miles
Factor	1, 1x10⁶, 1000, 100, 10, 0.001, 6.21371x10⁻⁶
Offset	0, 0, 0, 0, 0
Energy (Work)	Nm, kNm
Factor	1, 0.001
Offset	0, 0
Force	N, mN, kN
Factor	1, 1000, 0.001
Offset	0, 0, 0
Frequency	Hz, mHz, kHz, RPM
Factor	1, 1000, 0.001, 60,
Offset	0, 0, 0, 0,
Mass	g, μg, mg, kg, t
Factor	1, 1x10⁶, 1000, 0.001, 1x10⁻⁶
Offset	0, 0, 0, 0, 0
Percent	%
Factor	100
Offset	0
Pressure	bar, mbar,
Factor	1, 1000
Offset	0, 0
Resistance	Ohm, mOhm, kOhm
Factor	1, 1000, 0.001
Offset	0, 0, 0
Speed	m/s, km/h (3.6), mph
Factor	1, 3.6, 2.2369356
Offset	0, 0, 0
Strain	m/m, mm/m, μm/m, Stra, mStra, μStra
Factor	1, 1000, 1x10⁶, 1, 1000, 1x10⁶
Offset	0, 0, 0, 0, 0, 0

Time	s, ms, μs, ns, min, h, d
Factor	1, 1000, 1×10^6, 1×10^{12}, $1.666666666666667 \times 10^{-2}$, $2.777777777777778 \times 10^{-4}$, $1.15740740740741 \times 10^{-5}$
Offset	0, 0, 0, 0, 0, 0, 0
Temperature	°C, °K, °F, °RNK, °R
Factor	1, 1, 1.8, 1.8, 0.8
Offset	0, 273.15, 32, 491.67, 0
Voltage	V, μV, mV, kV
Factor	1, 1×10^6, 1000, 0.001
Offset	0, 0, 0, 0

7.3

Current Measurements with External Shunt

Current measurements are performed by measuring the voltage drop across a resistance of known size (i.e., shunt resistance). All Q.series XE modules that are suitable for direct current measurement possess an internal 50Ω resistor with which you can measure currents up to 25 mA (the maximum shunt power dissipation is limited to 0.25W) unless stated otherwise in this manual.

For current measurements higher than 25mA, configure the channel for voltage measurement and use an external shunt resistance terminal. The external shunt resistance terminal can be obtained under the designation *Q.bloxx Terminal SR* from Gantner Instruments or your domestic Gantner Instruments Sales and Service location

- ➔ The power dissipation of the current measured must be lower than the permissible power dissipation of the external shunt. In addition, the voltages produced on the resistance must not exceed the permissible input voltage on the analog input of the Q.series XE module.

! IMPORTANT

If using an external shunt, you must configure the analog input as a voltage measurement and divide the measured voltage by R_{ext} (external shunt resistance).

i Tip

The error of a current measurement with use of an external shunt depends on the accuracy of the resistor used.

7.4

Measurements with Thermocouples

Thermocouples consist of two thermoelectric wires made of dissimilar materials (e.g. platinum & platinum/rhodium) joined together at one end, usually by welding. If the temperature at the welded juncture, or contact point, differs from the other two ends of the thermoelectric wires then a thermoelectric voltage is produced at the contact point. This thermoelectric voltage is essentially proportional to the temperature difference between the contact point and the ends of the thermoelectric wires.

Since thermocouples can only measure the difference between the temperatures at the contact point and the module's input terminal, in order to ensure accurate measurement, either the terminal temperature must be known or the "transition" from thermocouple wire to copper wire must occur at a known temperature. The first case is known as internal cold junction compensation (TC_{int}) and the second case as external cold junction compensation, TC_{ext} .

To acquire temperature with *internal* cold junction compensation, an additional temperature probe is necessary to measure the reference temperature. For Q.series XE modules, it is necessary to have a cold junction compensation terminal block (CJC) with an integrated Pt1000 temperature probe to ensure accurate thermocouple measurement. With such terminal blocks, the temperature at the transition point is determined and the voltage produced by the thermocouple is corrected according to the type of thermocouple wire used.

To acquire temperature with *external* cold junction compensation, a second thermocouple of the same type is necessary. This second thermocouple is connected in series with the primary thermocouple. Polarities are chosen such that the thermoelectric voltages subtract from one another. The second thermocouple is usually located at a fixed reference temperature (e.g. 0°C). With such a setup, a Q.series XE module can calculate the temperature at the measuring point based on a linearization curve. This would require that the user define which temperature measurement in the Q.series XE module is being used as a reference cold point temperature.

7.5 List of Enumerations (ENUMs)

Each type of channel can have its own enumerations. The following enumerations are statically linked together and located in the FLASH of the DSP. The enumerations are set together by their usage. The enumerations are not set to a certain type of channel. Enumerations can be used with all kind of channels in parallel.

7.5.1 General

7.5.1.1 Channel Kind 0x08B0

Value	String	Description
0	Empty	
1	Analog Input	
2	Arithmetic	
3	Digital Output	
4	Digital Input	
5	Setpoint	
6	Alarm	
9	PID Controller	
A	Analog Output	
B	Signalcond	

7.5.1.2 Oversampling 0x0805

Value	String	Description
0	Standard	no filter configured
1	Oversample	
2	Async Buffer	

7.5.1.3 Oversample Rate 0x080A

For 100kHz modules, use the SDO shown below:

Value	String	Description
0	Not used 100kHz	no oversampling activated
1	100kHz	
2	50kHz	
5	20kHz	
10	10kHz	
20	5kHz	
50	2kHz	
100	1kHz	

For 20kHz modules, use the SDO shown below:

Value	String	Description
0	Not used 20kHz	no oversampling activated
1	20kHz	
2	10kHz	
4	5kHz	
10	2kHz	
20	1kHz	

7.5.2

Filter

7.5.2.1

Filter Type 0x0820

Value	String	Description
0	No Filter	No filter configured
1	Arithm	
2	Lowpass	
9	Highpass	
D	Bandpass	

7.5.2.2

Lowpass Filter Freq 0x0821

Value	String	Description
10000	10kHz	Lowpass frequencies supported, adjustable
5000	5kHz	
2000	2kHz	
1000	1kHz	
500	500Hz	
200	200Hz	
100	100Hz	
50	50Hz	
10	10Hz	
5	5Hz	
2	2Hz	
1	1Hz	

7.5.2.3

Highpass Filter Freq 0x0822

Value	String	Description
5000	5kHz	Highpass frequencies supported, adjustable
1000	1kHz	
500	500Hz	
100	100Hz	
50	50Hz	
10	10Hz	
5	5Hz	
1	1Hz	
-1	500mHz	
-2	100mHz	

7.5.2.4

Analog Input Measure Mode 0x0830

Value	String	Description
0	U	voltage
1	I	current
2	R	resistance
3	Bridge	bridge
4	TC	thermocouple
6	Poti	potentiometer

7.5.2.5

Wiring 0x0831

Value	String	Description
0	Par none	can be used for not defined configuration parameters
wiring-voltage		
1	single ended	single ended voltage measurement
2	differential	differential voltage input
F	IEPE	ICP input
wiring-resistance		
3	R 2 wire	resistance 2 wire
4	R 3 wire	resistance 3 wire
5	R 4 wire	resistance 4 wire
wiring-bridge		
8	half 3 wire	half bridge 3 wire
6	full 4 wire	full bridge 4 wire
9	half 5 wire	half bridge 5 wire
7	full 6 wire	full bridge 6 wire
wiring-TC		
A	CJ comp.	cold junction compensation voltage
B	diff. TC input	thermocouple input

7.5.2.6

Supply 0x0832

Value	String	Description
0	None	
1	1V	bridge supply value supported by the module
2	2.5V	
3	5V	
4	res	
5	res	
6	10V	
7	2V	
8	4V	

7.5.2.7

Supply Bridge Frequency 0x0833

Value	String	Description
0	None	
1	DC	
2	600Hz	
3	4k8Hz	

7.5.2.8

Sync 0x0834

Value	String	Description
0	None	
1	Free	
2	Master	send sync signal to backplane
3	Slave	use sync signal from backplane

7.5.2.9

Configuration has changed 0x0835

Value	String	Description
0	valid	the current parameter have not changed, no reload necessary
1	reload	the parameters have changed reload, activation necessary

7.5.2.10

Predefined linearization curves 0x0836

Value	String	Description
0	User	the currently active curve, no selection yet
1	TC K	TC type K full measure range 32 points -100...1200C
2	P100	PT100 32 points full range -200...800C
2	P1000	PT1000 32 points full range -200...800C

7.5.2.11 Configuration has changed 0x0852

Value	String	Description
0	valid	the current parameter has not changed, no reload necessary
1	reload	parameters changed, reload activation necessary

7.5.3 Null Tare

7.5.3.1 Mode 0x0840

Value	String	Description
0	Off	deactivated
1	Host	
2	Save EE	
4	Dig In	
8	On Var	

7.5.3.2 Null-Tare Activate 0x0841

Tare activate:

Value	String	Description
0	Off	deactivated
1	Tare	
2	Clear Tare	delete the currently active Tare-value

Null (Zero) activate:

Value	String	Description
0	Off	deactivated
4	Zero	
8	Clear Zero	delete the currently active Zero-value

7.5.4 Status

7.5.4.1 Trigger Status 0x0850

Value	String	Description
0	No trigger	trigger not active
1	Measuring	data is generated
2	Finalized	file ready for download

7.5.4.2 **Trigger Status II 0x0851**

Value	String	Description
0	active	
1	changed	

7.5.4.3 **Variable Status II 0x0852**

Value	String	Description
0	valid	all parameters active are the same as in the configuration file
1	reload	parameters are different, reload is necessary

7.5.5 **Scaling**7.5.5.1 **Physical Entity 0x0860**

Value	String	Description
0	V	
1	mV	
2	Hz	
FF	undef	

7.5.5.2 **Data Type 0x0861**

Value	String	Description
4	int	
6	long	
8	float	

7.5.5.3 **Data Direction 0x0862**

Value	String	Description
0	input	
1	output	
2	in/output	
3	empty	

7.5.5.4 **Error Modes 0x0870**

Value	String	Description
0	min&max	corresponding limits of the linearization curve
1	last value	last measured value inside the linearization curve range
2	default value	
3	none	

7.5.6 Digital Input

7.5.6.1 DI Type 0x0880

Value	String	Description
0	"not Def"	
1	"HostIn"	
2	"Frequency"	cronos
3	"Counter"	
4	"InputSet"	bitset
5	"PulseLength"	PWM

7.5.6.2 Sub Parameter 0 0x0881

Value	String	Description
0	"not def"	
1	"full"	
2	"lower"	
3	"higher"	
4	"quadratur"	
5	"UpDown"	
6	"interval"	
7	"DutyCycle"	

7.5.6.3 Sub Parameter 1 0x0882

Value	String	Description
0	"not def"	
1	"2 wire"	
2	"3 wire"	
3	"4 wire"	

7.5.6.4 Sub Parameter 2 0x0883

Value	String	Description
0	"not def"	
1	"rising"	
2	"falling"	
3	"both"	

7.5.6.5 Sub Parameter 3 0x0884

Value	String	Description
0	"not def"	
1	"single"	
2	"differential"	

7.5.7 Digital Output

7.5.7.1 DOut Type 0x0890

Value	String	Description
0	"no Output"	
1	"Host output"	
2	"PWM"	
3	"Process"	
4	"BitSet"	
5	"Logic"	
6	"Frequency"	
7	"FreqPWM"	

7.5.7.2 Sub Parameter 0 0x0891

Value	String	Description
0	"not def"	
1	"full"	
2	"lower"	
3	"higher"	
4	"PWM"	
5	"Freq"	

7.5.7.3 Sub Parameter 1 0x0892

Value	String	Description
0	"not def"	

7.5.7.4 Timeout Modes 0x08A3

Value	String	Description
0	"last"	during bus timeout the last output value stays active
1	"Default"	when the timeout flag is set this value is used

7.5.8 Analog Output

7.5.8.1 Analog Output Type 0x08A0

Value	String	Description
0	"V out"	voltage
1	"I out"	current

7.5.8.2 Analog Output Source 0x08A1

Value	String	Description
0	Dsp	a variable calculated by the DSP
3	Adc	an analog input
4	Const	a constant value
5	Din	a digital input

7.5.8.3 Analog Output Filter 0x08A2

Value	String	Description
0	83kHz	a variable calculated by the DSP
1	8.3kHz	an analog input
2	830Hz	a constant value

7.5.8.4 Channel Type 0x08B0

Value	String	Description
0	Empty	
1	Analog Input	
2	Arithmetic	
3	Digital Input	
4	Digital Output	
5	Setpoint	
6	Alarm	
9	PID Controller	
A	Analog Output	
B	Signalcond	

7.5.8.5 Timeout Modes 0x08B1

Value	String	Description
0	Last	
1	Default	

7.5.8.6

Output Channel Source Type 0x08B2

Value	String	Description
0	Dsp	
1	Input	Input data of other module
2	Output	Own output data
3	Adc	Own output data
4	Const	
5	Din	

7.5.8.7

Source of Output Channel (constant or variable) 0x08B3

Value	String	Description
-2	const	
0	V0	
1	V1	
x	Vx	
15	V15	

7.5.8.8

LED Flickering 0x08B4

Value	String	Description
0	LED off	LEDs are not controlled by the SDO
1	Flashing	the blue and red LED are flashing

7.5.8.9

Receiving File Status 0x08B5

Value	String	Description
0	No File received	
1	New File Received	
2	File saving	

7.5.8.10

Received File Type 0x08B6

Value	String	Description
0	Interface	
1	Config	
3	ET1100	
FA	FUC.TUP	
FB	FPGA	
FC	Calib	
FD	APP	
FE	OS	
FF	INVALID	default value, no file received

7.5.8.11

Received File Status 0x08B7

Value	String	Description
0	No processing	
1	File Processing	
2	Module Config	

8

Sales & Service Information

Contact information for your domestic Gantner Instruments Sales and Service location as well as our corporate headquarters, Gantner Instruments, can be found on our website at: <https://www.gantner-instruments.com>. You can select your region using the button at the top-right corner of the Gantner website.

You can find additional technical information in the Technical Information section of the Gantner Instruments Wiki at:

<https://dev.gantner-instruments.com/dokuwiki>.

Please use the following login information to gain access.

Username: *support*

Password: *gins*

(Note: Not all sections of the dokuwiki are open to the public).

Austria

Gantner Instruments

Montafonerstraße 4

6780 Schruns

Tel.: +43 (0) 5556 77463-0

Fax: +43 (0) 5556 77463-300

E-Mail: office@gantner-instruments.com

Web: www.gantner-instruments.com

Gantner Instruments GmbH

Montafonerstrasse 4
6780 Schruns
Austria

T +43 5556 77 463-0
info@gantner-instruments.com

www.gantner-instruments.com

Austria | Germany | France | Sweden | India | USA | China | Singapore



Test and Measurement Technology.
Designed for You.



Europe

