

# PT9510

Heavy Industrial • 0...5 Vdc, 0...10 Vdc

Absolute Linear Position to 550 inches (1400 cm)

Aluminum or Stainless Steel Enclosure Options

VLS Option To Prevent Free-Release Damage

IP68 • NEMA 6 Protection • Hazardous Area Certification



## GENERAL

Full Stroke Range Options (on this datasheet)	0-75 to 0-550 inches
Output Signal Options	0...10, 0...5, -5...+5, -10...+10 VDC
Accuracy	± 0.12% full stroke
Repeatability	± 0.05% full stroke
Resolution	essentially infinite
Measuring Cable Options	stainless steel or thermoplastic
Enclosure Material	powder-painted aluminum or 303 stainless steel
Sensor	plastic-hybrid precision potentiometer
Potentiometer Cycle Life	≥ 250,000
Maximum Retraction Acceleration	see ordering information
Maximum Velocity	see ordering information
Weight, Aluminum (Stainless Steel) Enclosure	8 lbs. (16 lbs.) max.

## ELECTRICAL

Input Voltage	14.5-40VDC (10.5-40VDC for 0-5 volt output)
Input Current	10 mA maximum
Output Impedance	1000 ohms
Maximum Output Load	5000 ohms
Output Signal, Zero Adjust	up to 50% of full stroke range
Output Signal, Span Adjust	to 50% of factory set span

## ENVIRONMENTAL

Enclosure	NEMA 4/4X/6, IP 67/68
Operating Temperature	-40° to 200°F (-40° to 90°C)
Vibration	up to 10 g to 2000 Hz maximum

## EMC COMPLIANCE PER DIRECTIVE 89/336/EEC

Emission / Immunity	EN50081-2 / EN50082-2
---------------------	-----------------------

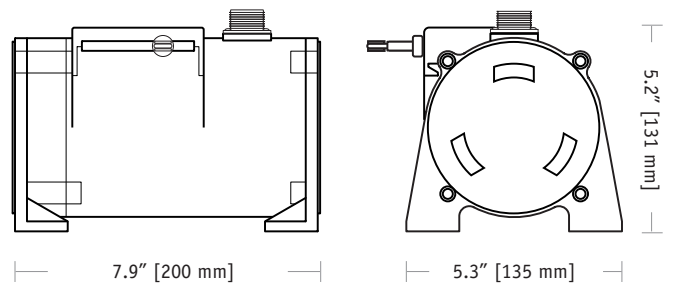
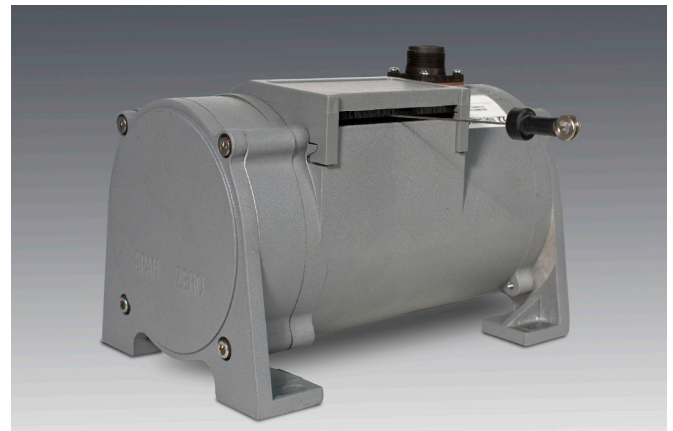

The PT9510 can operate from an unregulated 14.5 to 40 VDC power supply while providing a regulated output signal over its full extended range. It provides a 0 - 5 or 0 - 10 VDC position feedback signal proportional to the linear movement of its stainless steel measuring cable.

As a member of Celesco's innovative family of NEMA-4 rated cable-extension transducers, the PT9510 offers numerous benefits. It installs in minutes, functions properly without perfectly parallel alignment, and when its cable is retracted, it measures only 6".

## Output Signal:

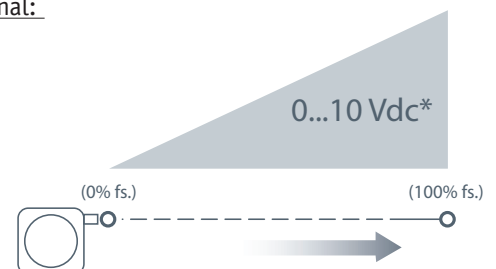

\*Additional Output Options: 0...5, -5...+5, -10...+10 Vdc

Fig. 1 – Outline Drawing (18 oz. cable tension only)

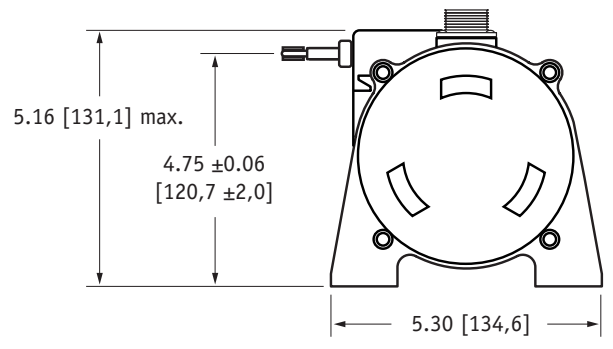
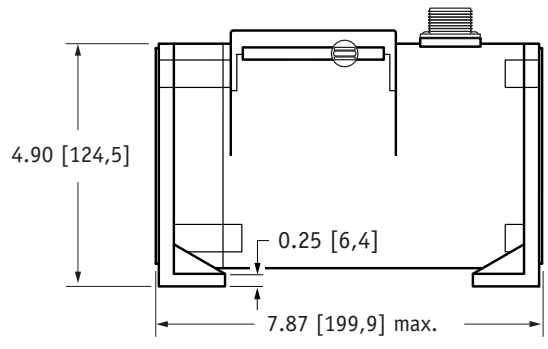
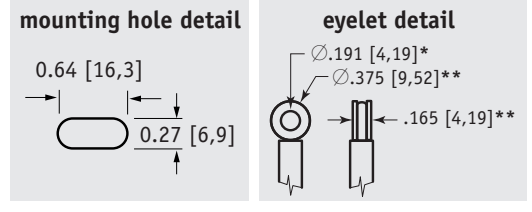
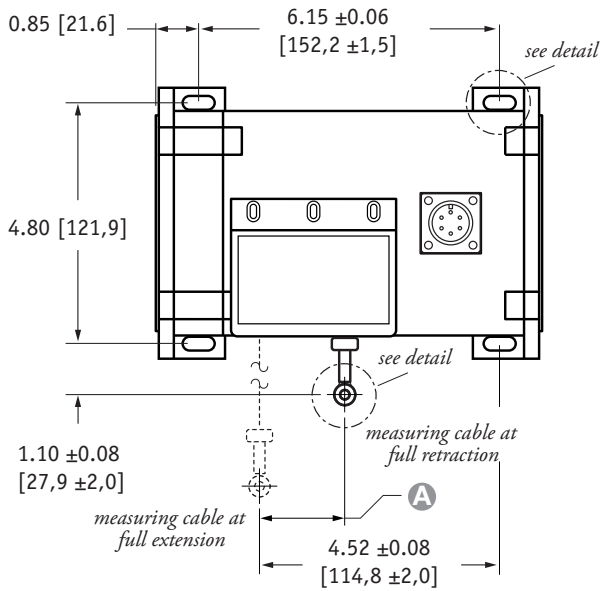

DIMENSIONS ARE IN INCHES [MM]  
tolerances are 0.03 IN. [0.5 MM] unless otherwise noted.

**A DIMENSION (INCHES)**

MEASURING CABLE				
RANGE	Ø.031 in.	Ø.034 in.	Ø.047 in.	Ø.062 in.
75	n/a	0.22	0.29	0.37
100	n/a	0.29	0.39	0.49
150	n/a	0.44	0.59	0.73
200	n/a	0.58	0.79	0.98
250	n/a	0.73	0.98	1.22
300	n/a	0.88	1.18	1.47
350	n/a	1.02	1.38	1.71
400	n/a	1.17	1.57	1.96
450	n/a	1.31	1.77	n/a
500	n/a	1.46	1.97	n/a
550	1.61	1.61	n/a	n/a

\* tolerance = +.005 -.001 [+,.13 -.03]  
\*\* tolerance = +.005 -.005 [+,.13 -.13]

**Ordering Information:**

**Model Number:**

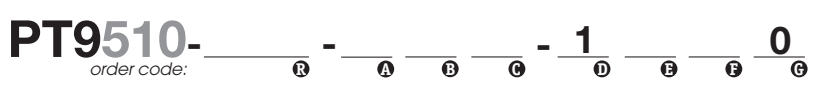

**Sample Model Number:**

**PT9510 - 0500 - 111 - 1110**

- R** range: 500 inches
- A** enclosure/cable tension: aluminum/18 oz.
- B** measuring cable: .034 nylon-coated stainless
- C** cable exit: front
- E** output signal: 0...10 vdc
- F** electrical connection: 6-pin plastic connector

**Full Stroke Range:**

<b>R</b> order code:	0075	0100	0150	0200	0250	0300	0350	0400	0450*	0500*	0550*
full stroke range, min:	75 in.	100 in.	150 in.	200 in.	250 in.	300 in.	350 in.	400 in.	450 in.	500 in.	550 in.

\* – 36 oz. cable tension strongly recommended

Ordering Information (cont.):

**Enclosure Material and Measuring Cable Tension:**

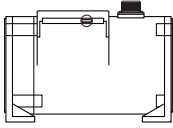
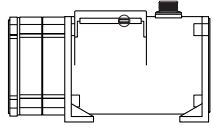
Ⓐ order code:	1	3	2	4
tension (±30%):	18 oz.		36 oz.	
enclosure material:	powder-painted aluminum	303 stainless steel	powder-painted aluminum	303 stainless steel
max. acceleration:	1 G	.33 G	5 G	2 G
max. velocity:	60 inches/sec	20 inches/sec	200 inches/sec	80 inches/sec
		standard housing see fig 1.		dual-spring housing see fig 2.







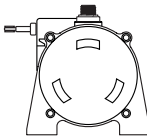
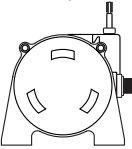
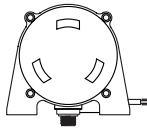
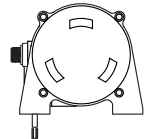

**Measuring Cable:**

Ⓑ order code:	1	2	3	4
cable construction:	Ø.034-inch nylon-coated stainless steel rope	Ø.047-inch bare stainless steel rope	Ø.058-inch PVC jacketed vectra fiber rope	Ø.031-inch bare stainless steel rope
available ranges:	all ranges	all ranges up to 500 inches	all ranges up to 400 inches	550-inch range only
general use:	indoor	outdoor, debris, high temperature	high voltage or magnetic field	outdoor, debris, high temperature

**Cable Exit:**

Ⓒ order code:	1	2	3	4
	front	top	back	down
				

**Output Signals:**

Ⓓ order code:	1	2	3	4	5	6	7	8
output signal options:	0...10 VDC 	10...0 VDC 	0...5 VDC 	5...0 VDC 	-10...+10 VDC 	+10...-10 VDC 	-5...+5 VDC 	+5...-5 VDC 
input voltage:	14.5 - 40 vdc				14.5 - 40 vdc		10.5 - 40 vdc	
span adjustment:	to 50% of full stroke range				to 75% of full stroke range		to 75% of full stroke range	
zero adjustment:	from factory set zero to 50% of full stroke range				from factory set zero to 25% of full stroke range			

example:

ordercode = 1 = 0...10 VDC →

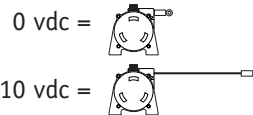

Ordering Information (cont.):

**Electrical Connection:**

**1** order code:

**1**  
6-pin plastic connector w/mating plug  
IP 67, NEMA 4X\*\*,6

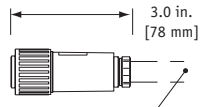

1/2 - 5/16" [14 - 8 mm] cable dia.  
16 AWG max conductor size  
connector: MS3102E-14S-6P  
mating plug: MS3106E-14S-6S

**2**

10-ft. [3 M]  
waterproof cable  
IP 67, NEMA 4X\*\*, 6

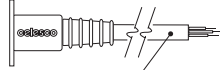

10 ft. x 0.4-in. dia.  
[3 M x 10 mm dia.]  
18 AWG, type SJOW

**3**

6-pin metal connector w/mating plug  
IP 65, NEMA 4

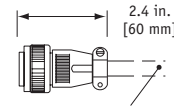

3/8-in. [9 mm] max cable dia.  
16 AWG max conductor size  
connector: MS3102E-14S-6P  
mating plug: MS3106E-14S-6S

**4**

25-ft. [7.5 M]  
instrumentation cable  
IP 67, NEMA 6

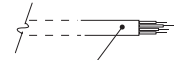

25 ft. x 0.2-in. dia.  
[7.5 M x 5 mm dia.]  
24 AWG, shielded

**5** order code:

100-ft. [30 M]  
waterproof cable  
IP 67, NEMA 4X\*\*,6

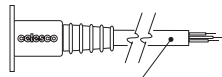

100 ft. x 0.4-in. dia.  
[30 M x 10 mm dia.]  
18 AWG, type SJTOW

**6**

10-ft. [3 M]  
pressure tested\*  
waterproof cable  
IP 68, NEMA 4X\*\*, 6P

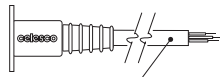

10 ft. x 0.4-in. dia.  
[3 M x 10 mm dia.]  
18 AWG, type SJTOW

**7**

100-ft. [30 M]  
pressure tested\*  
waterproof cable  
IP 68, NEMA 4X\*\*, 6P

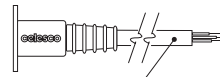

100 ft. x 0.4-in. dia.  
[30 M x 10 mm dia.]  
18 AWG, type SJTOW

**6-pin Mating Plug**

pin  
A input voltage  
B output signal  
C common

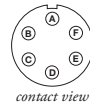

contact view

**Waterproof Cable**

color code  
WHITE input voltage  
GREEN output signal  
BLACK common

**Instrumentation Cable**

color code  
RED input voltage  
GREEN output signal  
BLACK common

Notes: { \* -Test pressure: 100 feet [30 meters] H<sub>2</sub>O (40 PSID); Test Medium: Air; Duration: 2 hours.  
\*\* -NEMA 4X applies to stainless steel enclosure only.

**Output Signal Selection (does not apply to -5...+5 & -10...+10 vdc options)**

output signal	switch setting	signal board
0...10 vdc		
10...0 vdc		
0...5 vdc		
5...0 vdc		

To gain access to the signal board, remove four Allen-Head Screws and remove end cover bracket.

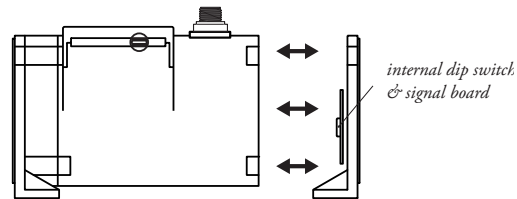

**Caution! Do Not Remove Spring-Side End Cover**  
Removing spring-side end cover could cause spring to become unseated and permanently damaged.

The output signal direction can be reversed at any time by simply changing the dip-switch settings found on the internal signal board. After the settings have been changed, adjustment of the Zero and Span trimpots will be required to precisely match signal values to the beginning and end points of the stroke.

Fig. 2 – Outline Drawing (36 oz. cable tension only)

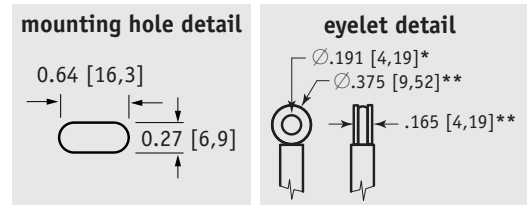
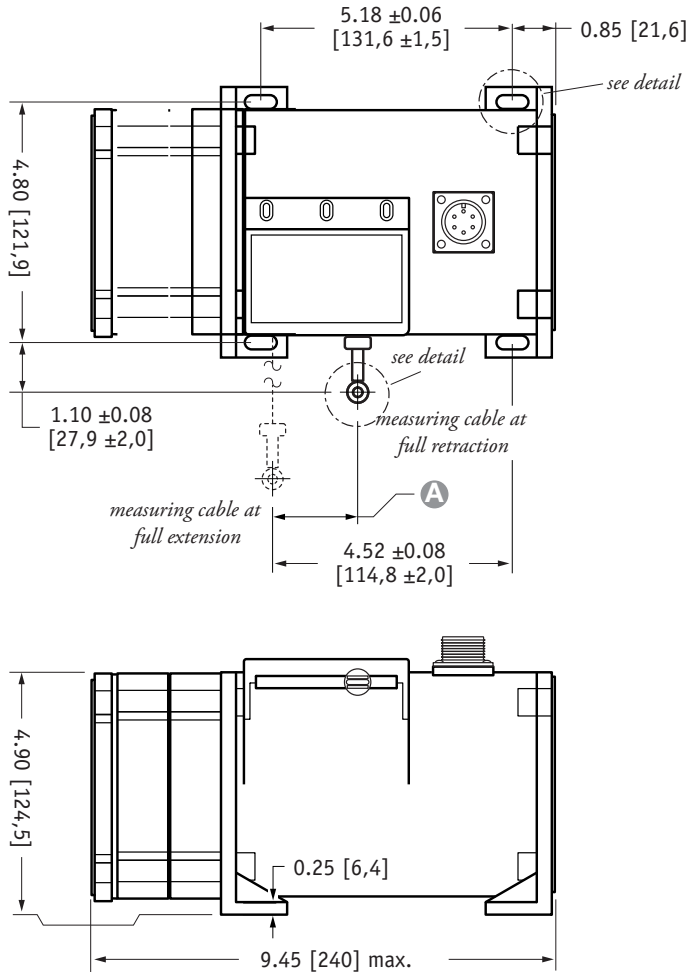

**A DIMENSION (INCHES)**

RANGE	MEASURING CABLE			
	Ø.031 in.	Ø.034 in.	Ø.047 in.	Ø.062 in.
75	n/a	0.22	0.29	0.37
100	n/a	0.29	0.39	0.49
150	n/a	0.44	0.59	0.73
200	n/a	0.58	0.79	0.98
250	n/a	0.73	0.98	1.22
300	n/a	0.88	1.18	1.47
350	n/a	1.02	1.38	1.71
400	n/a	1.17	1.57	1.96
450	n/a	1.31	1.77	n/a
500	n/a	1.46	1.97	n/a
550	1.61	1.61	n/a	n/a

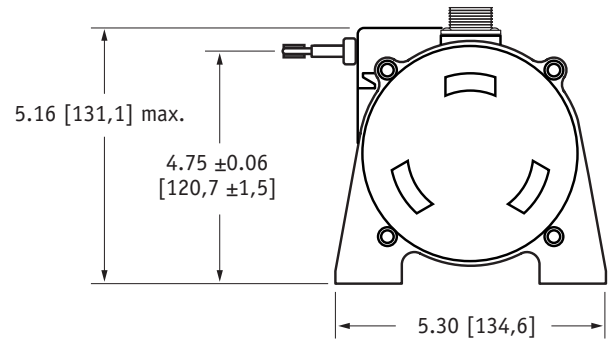

DIMENSIONS ARE IN INCHES [MM]  
tolerances are 0.03 IN. [0.5 MM] unless otherwise noted.

\* tolerance = +.005 -.001 [+.13 -.03]  
\*\* tolerance = +.005 -.005 [+.13 -.13]

## VLS Option - Free Release Protection

The patented Celesco Velocity Limiting System (VLS) is an option for PT9000 Series cable extension transducers that limits cable retraction to a safe 40 to 55 inches per second for the single spring option and 40 to 80 inches per second for the higher tension dual spring option.

The VLS option prevents the measuring cable from ever reaching a damaging velocity during an accidental free release. This option is ideal for mobile applications that require frequent cable disconnection and reconnection. It prevents expensive unscheduled downtime due to accidental cable mishandling or attachment failure.

### How To Configure Model Number for VLS Option:

**VLS9510** -      -      -      -      -      -      -      -     

creating VLS model number (example)...

- select PT9510 model **PT9510-0100-111-1110**
- remove "PT" from the model number **9510-0100-111-1110**
- add "VLS" **VLS + 9510-0100-111-1110**
- completed model number ! **VLS9510-0100-111-1110**

version: 11.0 last updated: June 24, 2014