

① Wetterschutz
Weather protection
Protection contre intempéries

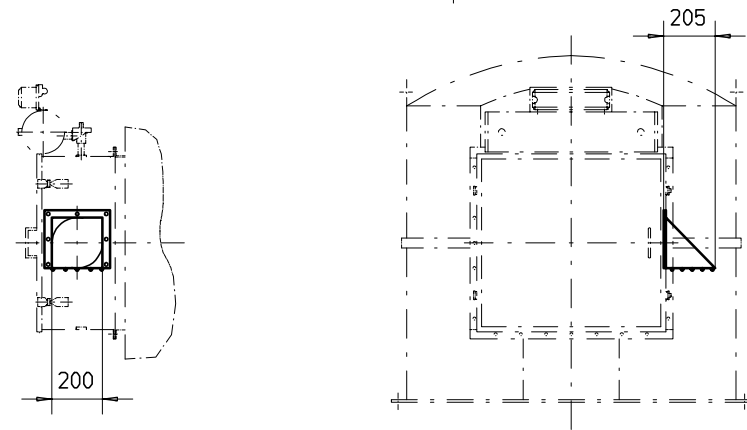

② Reingasstutzen
Outlet connection
Tubulure sortie gaz épuré

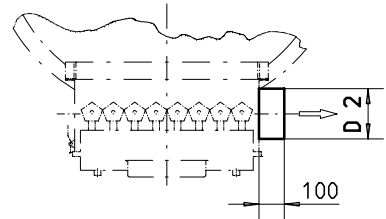

③ Schutzgehäuse
Protective housing
Caisson de protection

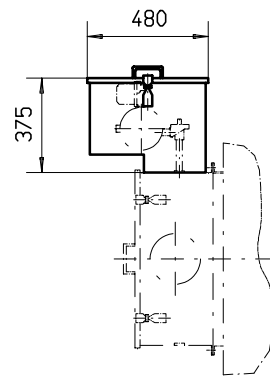

④ Einschweißzarge
Mounting spigot
Pièce de raccordement

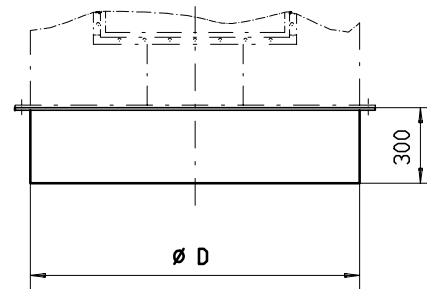

⑤ Ventilatoranbau
Fan support
Support de ventilateur

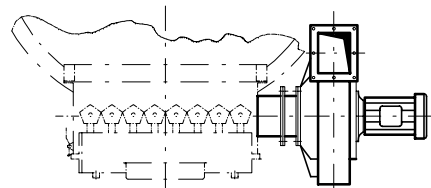

Ventilatoranbau
Fan data see back side
Caractéristiques des ventilateur
voir au verso

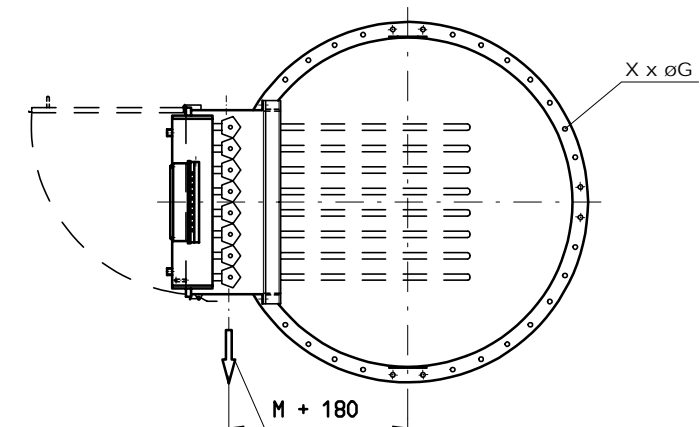
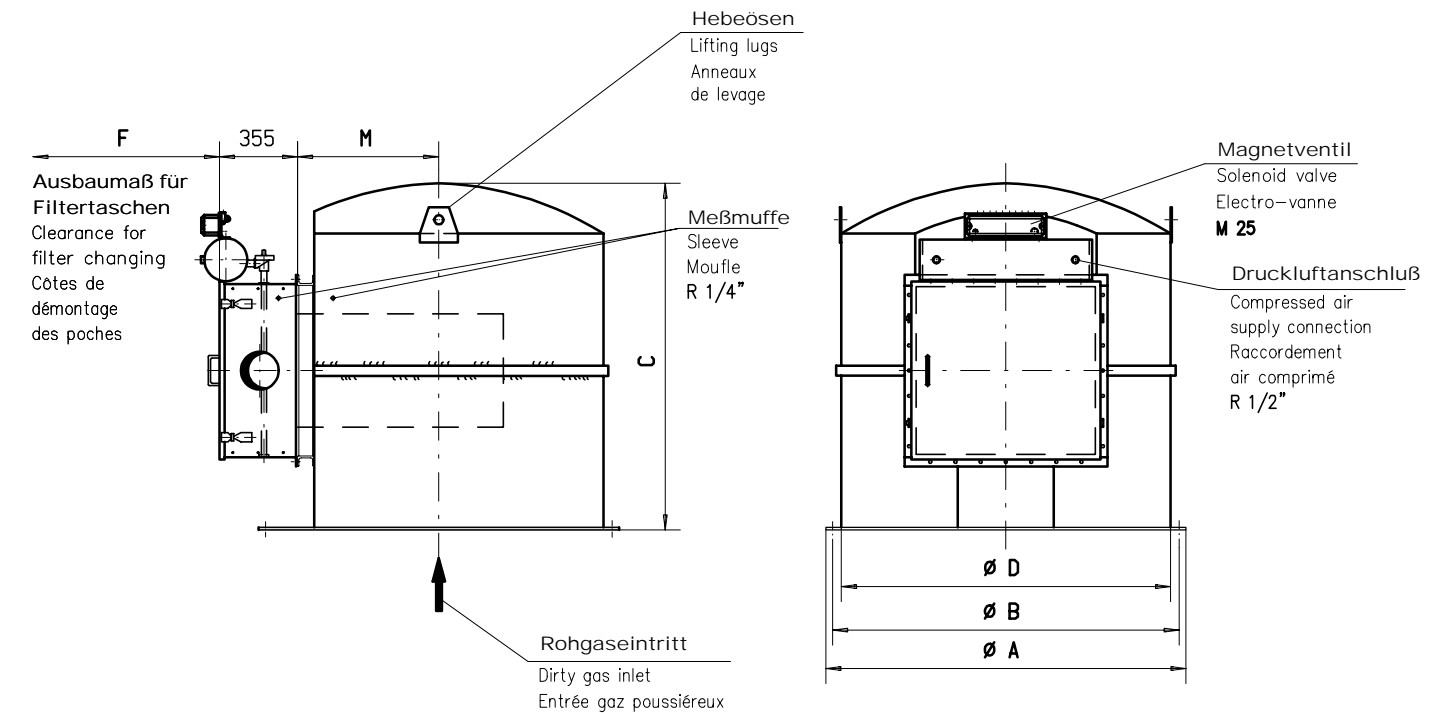

Weiteres Zubehör / Other accessories / Autres accessoires:

- s. Reg. 9 + 10 / see chapter 9 + 10 / voir registre 9 + 10
- * Steuergerät / Control unit / Coffret de commande
- * Differenzdruck-Meßgerät / Differential press. instrument / Appareil de mesure
- * Steuerluftdruckführung / Venting of solenoid valve / Rejet de l'air des vannes
- * Wartungseinheit / Maintenance unit / Unité d'entretien
- * Winterschutz / Winter protection / Protection contre le gel

Alle Stutzen lieferbar mit / Connecting piece available with /
Pièce de raccordement livrable avec:
Flansch nach / Flange as per / Bride conforme à: DIN 24154/2
oder Bördel / or clamping flange / ou bride bordée
s. Reg. 9 / see chapter 9 / voir registre 9

Konstruktionsänderungen vorbehalten !
Dimensions subject to alterations !
Côtes données sous réserve de modifications !

Filtertyp Type Type	Weight Poids [kg]	Weight Poids [kg]	ø D2 [mm]	Weight Poids [kg]	Weight Poids [kg]	Weight Poids [kg]	Filtertyp Type Type	Filterfläche Filter area Surface filtrante [m²]	Anzahl Filtertaschen Nb. des poches	Weight Poids [kg]	øA [mm]	øB [mm]	C [mm]	øD [mm]	F [mm]	X x øG [mm]	H [mm]	M [mm]	R [mm]
AJN 034 RBFH	4	2	150	14	33	33	AJN 034 RBFH	3	4	210	1229	1175	1250	1100	850	36 x 18	632	560	150
AJN 064 RBFH	4	3	200	18	40	40	AJN 064 RBFH	6	8	300	1429	1375	1375	1300	850	36 x 18	632	570	200
AJN 104 RBFH	4	3	200	17	33	33	AJN 104 RBFH	10	12	325	1229	1175	1550	1100	850	36 x 18	807	510	200
AJN 124 RBFH	4	3	200	17	40	40	AJN 124 RBFH	12	12	390	1429	1375	1675	1300	1110	36 x 18	807	630	200
AJN 154 RBFH	4	3	250	21	40	40	AJN 154 RBFH	15	20	450	1429	1375	1675	1300	850	36 x 18	807	490	250
AJN 204 RBFH	4	3	250	21	52	52	AJN 204 RBFH	20	20	520	1629	1575	1705	1500	1110	48 x 18	807	630	250