

① Wetterschutz  
Weather protection  
Protection contre intempéries

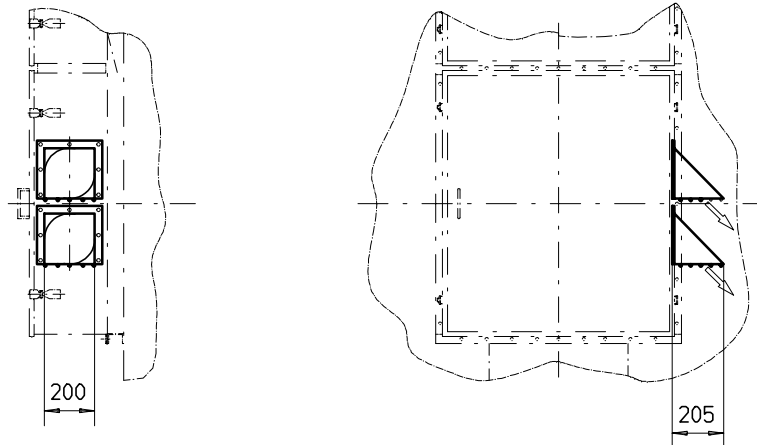

② Reingasstutzen  
Outlet connection  
Tubulure sortie gaz épuré

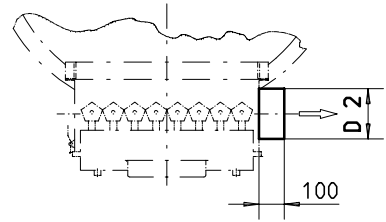

③ Schutzgehäuse  
Protective housing  
Caisson de protection

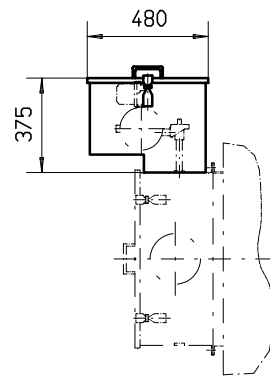

④ Einschweißzarge  
Mounting spigot  
Pièce de raccordement

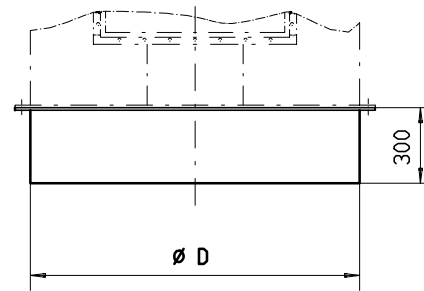

⑤ Ventilatoranbau  
Fan support  
Support de ventilateur

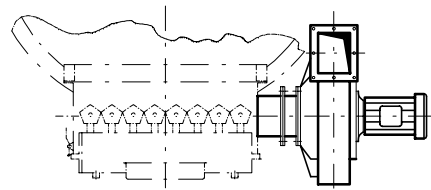

Ventilatoranbau  
Fan data see back side  
Caractéristiques des ventilateur  
voir au verso

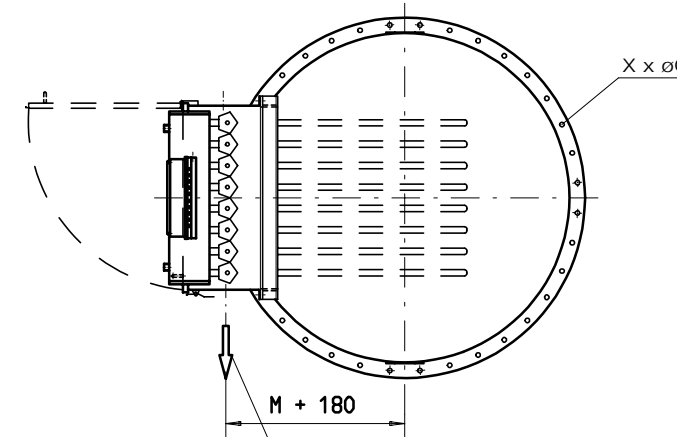
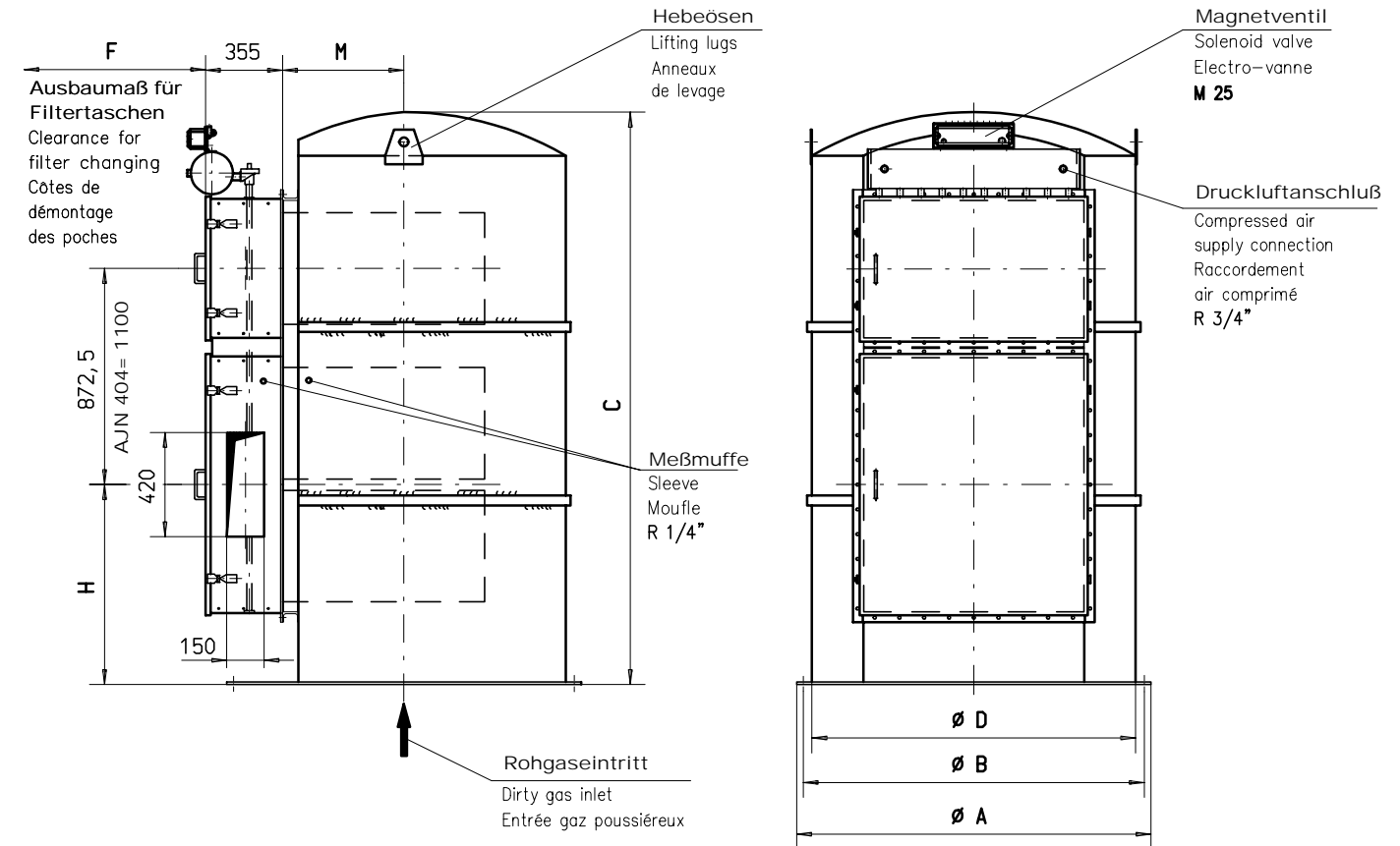

Reingasaustritt auf Wunsch links  
Clean gas outlet on request to the left  
Sortie gaz épuré sur demande à gauche

Konstruktionsänderungen vorbehalten!  
Dimensions subject to alterations!  
Côtes données sous réserve de modifications!

Weiteres Zubehör / Other accessories / Autres accessoires:

- s. Reg. 9 + 10 / see chapter 9 + 10 / voir registre 9 + 10
- \* Steuergerät / Control unit / Coffret de commande
- \* Differenzdruck-Meßgerät / Differential press. instrument / Appareil de mesure
- \* Steuerluftdruckführung / Venting of solenoid valve / Rejet de l'air des vannes
- \* Wartungseinheit / Maintenance unit / Unité d'entretien
- \* Winterschutz / Winter protection / Protection contre le gel

Alle Stutzen lieferbar mit / Connecting piece available with /  
Pièce de raccordement livrable avec:  
Flansch nach / Flange as per / Bride conforme à: DIN 24154/2  
oder Bördel / or clamping flange / ou bride bordée  
s. Reg. 9 / see chapter 9 / voir registre 9

Filtertyp Type Type	Weight Poids [kg]	Weight Poids [kg]	Weight Poids [kg]	Weight Poids [kg]	Weight Poids [kg]	Weight Poids [kg]	Weight Poids [kg]	Filtertyp Type Type	Filterfläche Filter area Surface filtrante [m <sup>2</sup> ]	Anzahl Filtertaschen Nb. des poches	Weight Poids [kg]	øA [mm]	øB [mm]	C [mm]	øD [mm]	F [mm]	X x øG [mm]	H [mm]	M [mm]
AJN 234 RBFH	8	6	21	50	21	50	50	AJN 234 RBFH	23	30	615	1429	1375	2310	1300	850	36 x 18	807	490
AJN 304 RBFH	8	6	21	60	21	60	60	AJN 304 RBFH	30	30	765	1629	1575	2440	1500	1100	48 x 18	907	630
AJN 404 RBFH	8	6	21	60	21	60	60	AJN 404 RBFH	40	40	900	1629	1575	2915	1500	1100	48 x 18	907	630